

# MOTOROLA SEMICONDUCTOR TECHNICAL DATA

## 1–1.3 Watt DO-41 Glass Zener Voltage Regulator Diodes

### GENERAL DATA APPLICABLE TO ALL SERIES IN THIS GROUP

## One Watt Hermetically Sealed Glass Silicon Zener Diodes

#### Specification Features:

- Complete Voltage Range — 3.3 to 100 Volts
- DO-41 Package
- Double Slug Type Construction
- Metallurgically Bonded Construction
- Oxide Passivated Die

#### Mechanical Characteristics:

**CASE:** Double slug type, hermetically sealed glass

**MAXIMUM LEAD TEMPERATURE FOR SOLDERING PURPOSES:** 230°C, 1/16" from case for 10 seconds

**FINISH:** All external surfaces are corrosion resistant with readily solderable leads

**POLARITY:** Cathode indicated by color band. When operated in zener mode, cathode will be positive with respect to anode

**MOUNTING POSITION:** Any

**WAFER FAB LOCATION:** Phoenix, Arizona

**ASSEMBLY/TEST LOCATION:** Seoul, Korea

**1N4728A  
SERIES  
1–1.3 WATT  
DO-41 GLASS**

**1 WATT  
ZENER REGULATOR  
DIODES  
3.3–100 VOLTS**

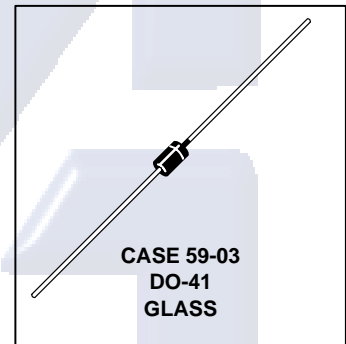

#### MAXIMUM RATINGS

Rating	Symbol	Value	Unit
DC Power Dissipation @ $T_A = 50^\circ\text{C}$ Derate above $50^\circ\text{C}$	$P_D$	1 6.67	Watt $\text{mW}/^\circ\text{C}$
Operating and Storage Junction Temperature Range	$T_J, T_{stg}$	-65 to +200	$^\circ\text{C}$

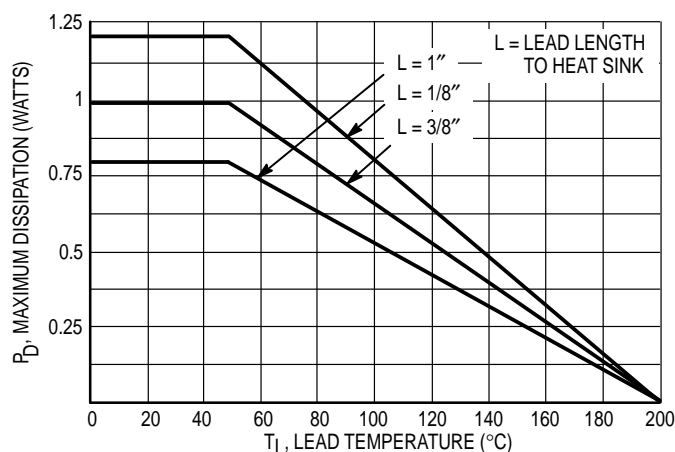

Figure 1. Power Temperature Derating Curve

## GENERAL DATA — 500 mW DO-35 GLASS

\*ELECTRICAL CHARACTERISTICS ( $T_A = 25^\circ\text{C}$  unless otherwise noted)  $V_F = 1.2\text{ V Max}$ ,  $I_F = 200\text{ mA}$  for all types.

JEDEC Type No. (Note 1)	Nominal Zener Voltage $V_Z @ I_{ZT}$ Volts (Notes 2 and 3)	Test Current $I_{ZT}$ mA	Maximum Zener Impedance (Note 4)			Leakage Current		Surge Current @ $T_A = 25^\circ\text{C}$ $i_r$ - mA (Note 5)
			$Z_{ZT} @ I_{ZT}$ Ohms	$Z_{ZK} @ I_{ZK}$ Ohms	$I_{ZK}$ mA	$I_R$ $\mu\text{A Max}$	$V_R$ Volts	
1N4728A	3.3	76	10	400	1	100	1	1380
1N4729A	3.6	69	10	400	1	100	1	1260
1N4730A	3.9	64	9	400	1	50	1	1190
1N4731A	4.3	58	9	400	1	10	1	1070
1N4732A	4.7	53	8	500	1	10	1	970
<b>1N4733A</b>	<b>5.1</b>	<b>49</b>	<b>7</b>	<b>550</b>	<b>1</b>	<b>10</b>	<b>1</b>	<b>890</b>
<b>1N4734A</b>	<b>5.6</b>	<b>45</b>	<b>5</b>	<b>600</b>	<b>1</b>	<b>10</b>	<b>2</b>	<b>810</b>
<b>1N4735A</b>	<b>6.2</b>	<b>41</b>	<b>2</b>	<b>700</b>	<b>1</b>	<b>10</b>	<b>3</b>	<b>730</b>
<b>1N4736A</b>	<b>6.8</b>	<b>37</b>	<b>3.5</b>	<b>700</b>	<b>1</b>	<b>10</b>	<b>4</b>	<b>660</b>
1N4737A	7.5	34	4	700	0.5	10	5	605
<b>1N4738A</b>	<b>8.2</b>	<b>31</b>	<b>4.5</b>	<b>700</b>	<b>0.5</b>	<b>10</b>	<b>6</b>	<b>550</b>
1N4739A	9.1	28	5	700	0.5	10	7	500
<b>1N4740A</b>	<b>10</b>	<b>25</b>	<b>7</b>	<b>700</b>	<b>0.25</b>	<b>10</b>	<b>7.6</b>	<b>454</b>
<b>1N4741A</b>	<b>11</b>	<b>23</b>	<b>8</b>	<b>700</b>	<b>0.25</b>	<b>5</b>	<b>8.4</b>	<b>414</b>
<b>1N4742A</b>	<b>12</b>	<b>21</b>	<b>9</b>	<b>700</b>	<b>0.25</b>	<b>5</b>	<b>9.1</b>	<b>380</b>
1N4743A	13	19	10	700	0.25	5	9.9	344
<b>1N4744A</b>	<b>15</b>	<b>17</b>	<b>14</b>	<b>700</b>	<b>0.25</b>	<b>5</b>	<b>11.4</b>	<b>304</b>
<b>1N4745A</b>	<b>16</b>	<b>15.5</b>	<b>16</b>	<b>700</b>	<b>0.25</b>	<b>5</b>	<b>12.2</b>	<b>285</b>
<b>1N4746A</b>	<b>18</b>	<b>14</b>	<b>20</b>	<b>750</b>	<b>0.25</b>	<b>5</b>	<b>13.7</b>	<b>250</b>
<b>1N4747A</b>	<b>20</b>	<b>12.5</b>	<b>22</b>	<b>750</b>	<b>0.25</b>	<b>5</b>	<b>15.2</b>	<b>225</b>
<b>1N4748A</b>	<b>22</b>	<b>11.5</b>	<b>23</b>	<b>750</b>	<b>0.25</b>	<b>5</b>	<b>16.7</b>	<b>205</b>
<b>1N4749A</b>	<b>24</b>	<b>10.5</b>	<b>25</b>	<b>750</b>	<b>0.25</b>	<b>5</b>	<b>18.2</b>	<b>190</b>
<b>1N4750A</b>	<b>27</b>	<b>9.5</b>	<b>35</b>	<b>750</b>	<b>0.25</b>	<b>5</b>	<b>20.6</b>	<b>170</b>
<b>1N4751A</b>	<b>30</b>	<b>8.5</b>	<b>40</b>	<b>1000</b>	<b>0.25</b>	<b>5</b>	<b>22.8</b>	<b>150</b>
<b>1N4752A</b>	<b>33</b>	<b>7.5</b>	<b>45</b>	<b>1000</b>	<b>0.25</b>	<b>5</b>	<b>25.1</b>	<b>135</b>
1N4753A	36	7	50	1000	0.25	5	27.4	125
1N4754A	39	6.5	60	1000	0.25	5	29.7	115
1N4755A	43	6	70	1500	0.25	5	32.7	110
1N4756A	47	5.5	80	1500	0.25	5	35.8	95
1N4757A	51	5	95	1500	0.25	5	38.8	90
1N4758A	56	4.5	110	2000	0.25	5	42.6	80
1N4759A	62	4	125	2000	0.25	5	47.1	70
1N4760A	68	3.7	150	2000	0.25	5	51.7	65
1N4761A	75	3.3	175	2000	0.25	5	56	60
1N4762A	82	3	200	3000	0.25	5	62.2	55
1N4763A	91	2.8	250	3000	0.25	5	69.2	50
1N4764A	100	2.5	350	3000	0.25	5	76	45

\*Indicates JEDEC Registered Data.

**NOTE 1. TOLERANCE AND TYPE NUMBER DESIGNATION**

The JEDEC type numbers listed have a standard tolerance on the nominal zener voltage of  $\pm 5\%$ . C for  $\pm 2\%$ , D for  $\pm 1\%$ .

**NOTE 2. SPECIALS AVAILABLE INCLUDE:**

Nominal zener voltages between the voltages shown and tighter voltage tolerances.

For detailed information on price, availability, and delivery, contact your nearest Motorola representative.

**NOTE 3. ZENER VOLTAGE ( $V_Z$ ) MEASUREMENT**

Motorola guarantees the zener voltage when measured at 90 seconds while maintaining the lead temperature ( $T_L$ ) at  $30^\circ\text{C} \pm 1^\circ\text{C}$ , 3/8" from the diode body.

**NOTE 4. ZENER IMPEDANCE ( $Z_Z$ ) DERIVATION**

The zener impedance is derived from the 60 cycle ac voltage, which results when an ac current having an rms value equal to 10% of the dc zener current ( $I_{ZT}$  or  $I_{ZK}$ ) is superimposed on  $I_{ZT}$  or  $I_{ZK}$ .

**NOTE 5. SURGE CURRENT ( $i_r$ ) NON-REPETITIVE**

The rating listed in the electrical characteristics table is maximum peak, non-repetitive, reverse surge current of 1/2 square wave or equivalent sine wave pulse of 1/120 second duration superimposed on the test current,  $I_{ZT}$ , per JEDEC registration; however, actual device capability is as described in Figure 5 of the General Data — DO-41 Glass.

# GENERAL DATA — 500 mW DO-35 GLASS

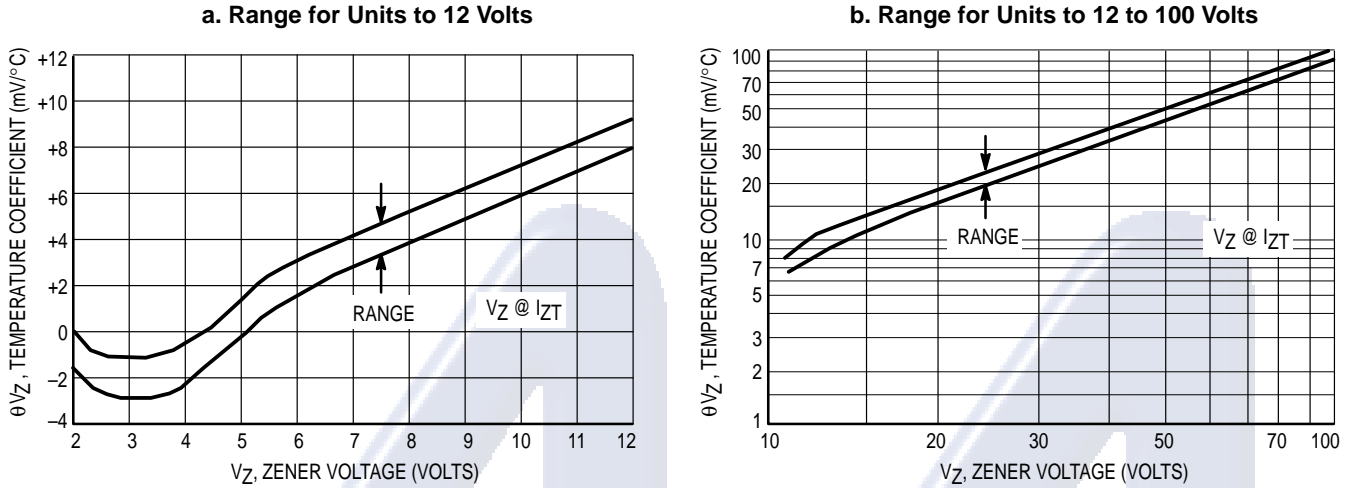

**Figure 2. Temperature Coefficients**  
 (-55°C to +150°C temperature range; 90% of the units are in the ranges indicated.)

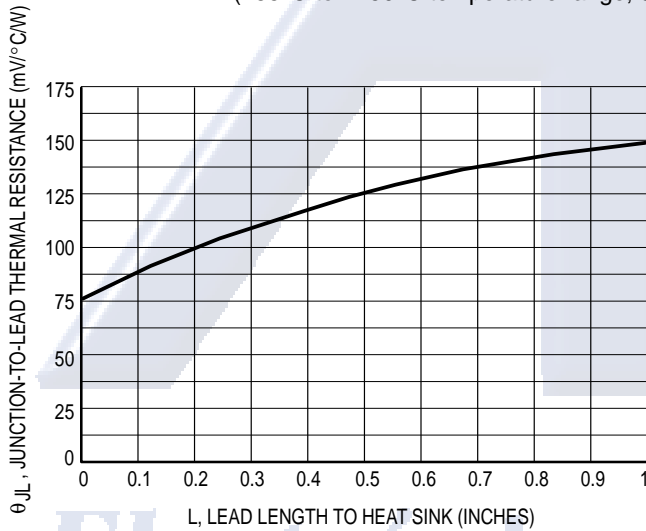

**Figure 3. Typical Thermal Resistance versus Lead Length**

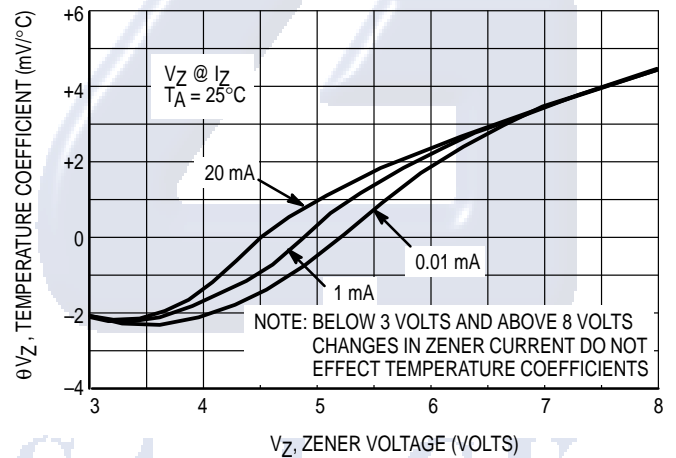

**Figure 4. Effect of Zener Current**

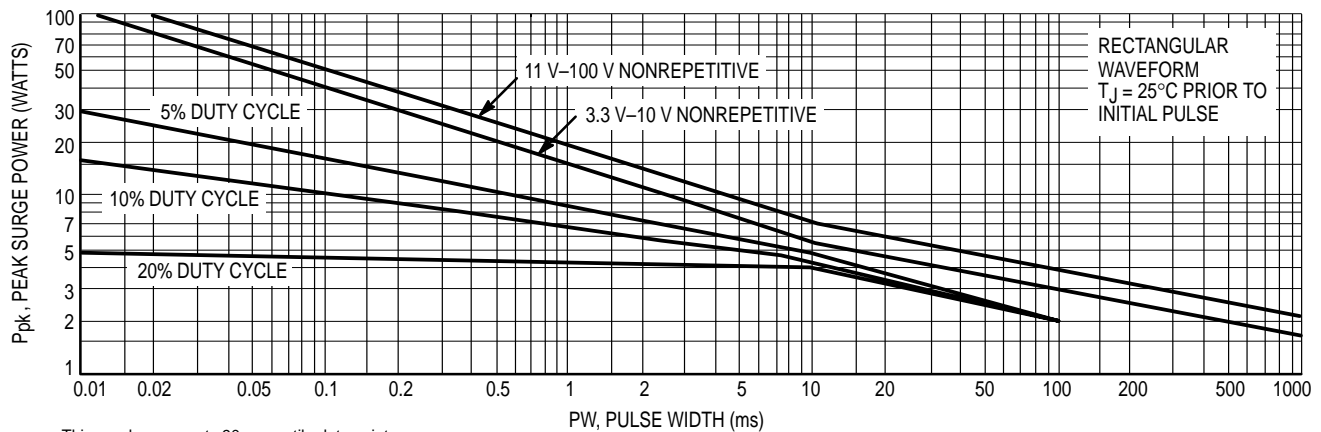

This graph represents 90 percentile data points.  
 For worst case design characteristics, multiply surge power by 2/3.

**Figure 5. Maximum Surge Power**

# GENERAL DATA — 500 mW DO-35 GLASS

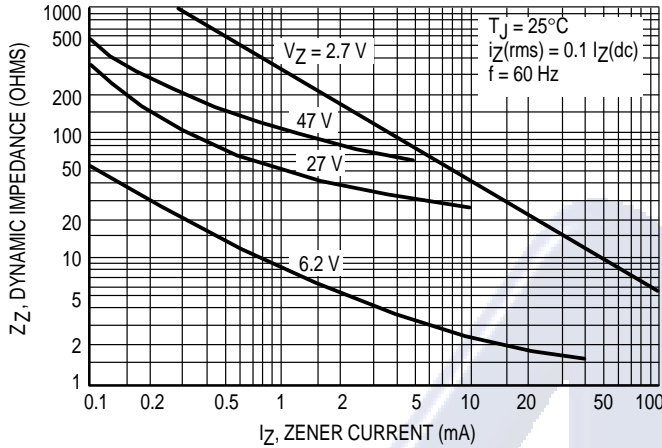

Figure 6. Effect of Zener Current on Zener Impedance

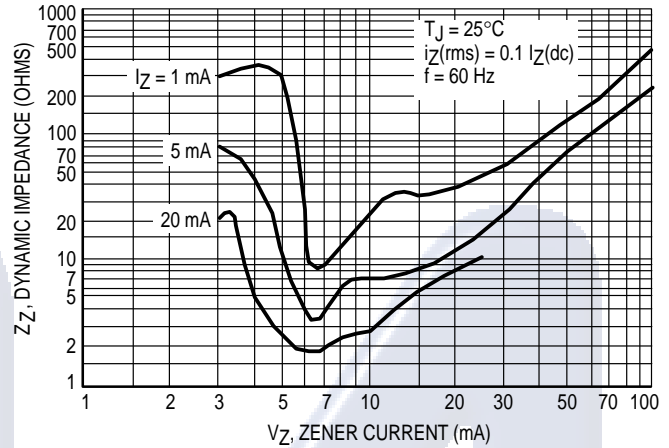

Figure 7. Effect of Zener Voltage on Zener Impedance

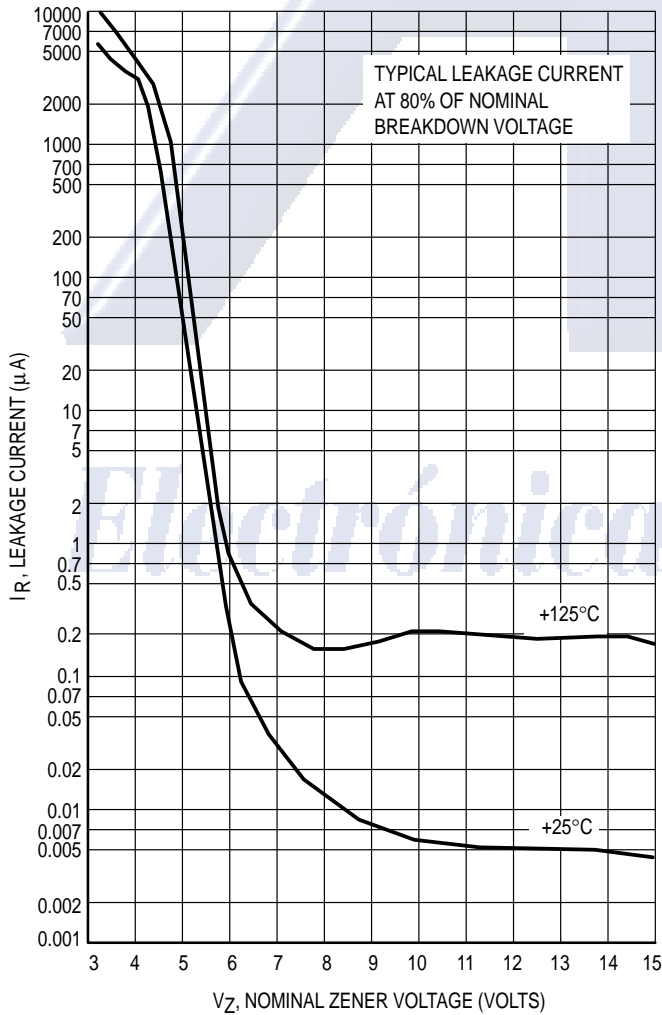

Figure 8. Typical Leakage Current

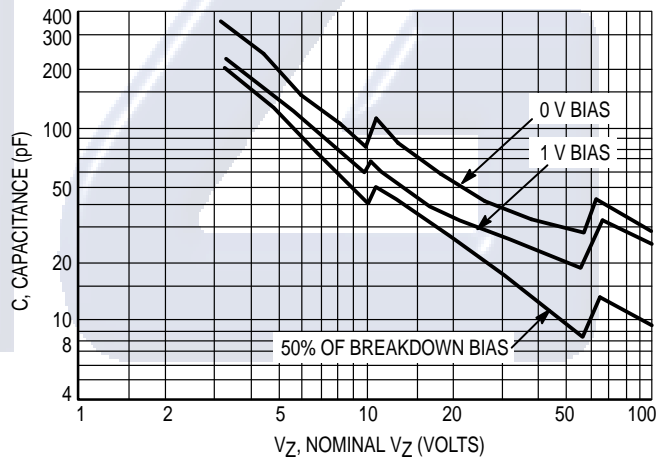

Figure 9. Typical Capacitance versus  $V_z$

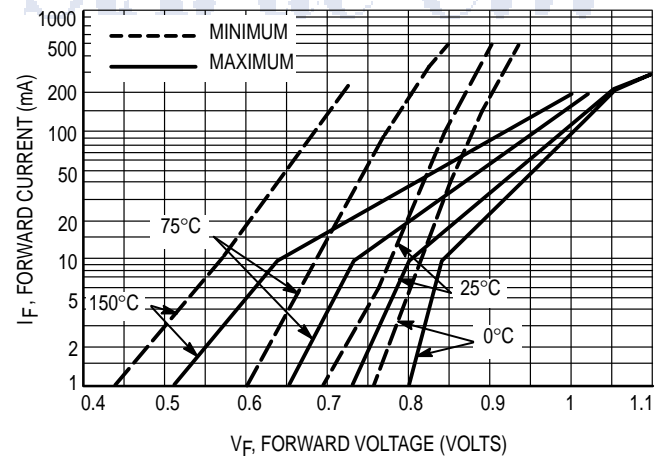

Figure 10. Typical Forward Characteristics

## GENERAL DATA — 500 mW DO-35 GLASS

### APPLICATION NOTE

Since the actual voltage available from a given zener diode is temperature dependent, it is necessary to determine junction temperature under any set of operating conditions in order to calculate its value. The following procedure is recommended:

Lead Temperature,  $T_L$ , should be determined from:

$$T_L = \theta_{LA} P_D + T_A.$$

$\theta_{LA}$  is the lead-to-ambient thermal resistance ( $^{\circ}\text{C}/\text{W}$ ) and  $P_D$  is the power dissipation. The value for  $\theta_{LA}$  will vary and depends on the device mounting method.  $\theta_{LA}$  is generally 30 to  $40^{\circ}\text{C}/\text{W}$  for the various clips and tie points in common use and for printed circuit board wiring.

The temperature of the lead can also be measured using a thermocouple placed on the lead as close as possible to the tie point. The thermal mass connected to the tie point is normally large enough so that it will not significantly respond to heat surges generated in the diode as a result of pulsed operation once steady-state conditions are achieved. Using the measured value of  $T_L$ , the junction temperature may be determined by:

$$T_J = T_L + \Delta T_{JL}.$$

$\Delta T_{JL}$  is the increase in junction temperature above the lead

temperature and may be found as follows:

$$\Delta T_{JL} = \theta_{JL} P_D.$$

$\theta_{JL}$  may be determined from Figure 3 for dc power conditions. For worst-case design, using expected limits of  $I_Z$ , limits of  $P_D$  and the extremes of  $T_J(\Delta T_J)$  may be estimated. Changes in voltage,  $V_Z$ , can then be found from:

$$\Delta V = \theta_{VZ} \Delta T_J.$$

$\theta_{VZ}$ , the zener voltage temperature coefficient, is found from Figure 2.

Under high power-pulse operation, the zener voltage will vary with time and may also be affected significantly by the zener resistance. For best regulation, keep current excursions as low as possible.

Surge limitations are given in Figure 5. They are lower than would be expected by considering only junction temperature, as current crowding effects cause temperatures to be extremely high in small spots, resulting in device degradation should the limits of Figure 5 be exceeded.

*Electrónica S.A. de C.V.*

## GENERAL DATA — 500 mW DO-35 GLASS

## Zener Voltage Regulator Diodes — Axial Ledded

## 1–1.3 Watt DO-41 Glass

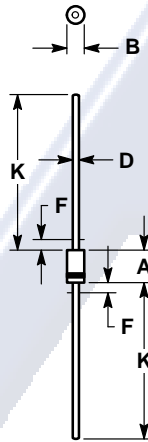

- NOTES:
1. ALL RULES AND NOTES ASSOCIATED WITH JEDEC DO-41 OUTLINE SHALL APPLY.
  2. POLARITY DENOTED BY CATHODE BAND.
  3. LEAD DIAMETER NOT CONTROLLED WITHIN F DIMENSION.

DIM	MILLIMETERS		INCHES	
	MIN	MAX	MIN	MAX
A	4.07	5.20	0.160	0.205
B	2.04	2.71	0.080	0.107
D	0.71	0.86	0.028	0.034
F	—	1.27	—	0.050
K	27.94	—	1.100	—

CASE 59-03  
DO-41  
GLASS

(Refer to Section 10 for Surface Mount, Thermal Data and Footprint Information.)

### MULTIPLE PACKAGE QUANTITY (MPQ) REQUIREMENTS

Package Option	Type No. Suffix	MPQ (Units)
Tape and Reel	RL, RL2	6K
Tape and Ammo	TA, TA2	4K

NOTE: 1. The "2" suffix refers to 26 mm tape spacing.

(Refer to Section 10 for more information on Packaging Specifications.)