

LAPT 2SC3284

Silicon NPN Epitaxial Planar Transistor (Complement to type 2SA1303)

Application : Audio and General Purpose

Absolute maximum ratings (Ta=25°C)

Symbol	2SC3284	Unit
V _{CB0}	150	V
V _{CE0}	150	V
V _{EB0}	5	V
I _C	14	A
I _B	3	A
P _C	125(T _C =25°C)	W
T _J	150	°C
T _{stg}	-55 to +150	°C

Electrical Characteristics (Ta=25°C)

Symbol	Conditions	2SC3284	Unit
I _{CB0}	V _{CB} =150V	100max	μA
I _{EB0}	V _{EB} =5V	100max	μA
V(BR) _{CEO}	I _C =25mA	150min	V
h _{FE}	V _{CE} =4V, I _C =5A	50min*	
V _{CE(sat)}	I _C =5A, I _B =0.5A	2.0max	V
f _r	V _{CE} =12V, I _E =-2A	60typ	MHz
COB	V _{CB} =10V, f=1MHz	200typ	pF

*h_{FE} Rank \bar{O} (50 to 100), P(70 to 140), Y(90 to 180)

Typical Switching Characteristics (Common Emitter)

V _{CC} (V)	R _L (Ω)	I _C (A)	V _{BB1} (V)	V _{BB2} (V)	I _{B1} (A)	I _{B2} (A)	t _{on} (μs)	t _{stg} (μs)	t _f (μs)
60	12	5	10	-5	0.5	-0.5	0.2typ	1.5typ	0.35typ

External Dimensions MT-100(TO3P)

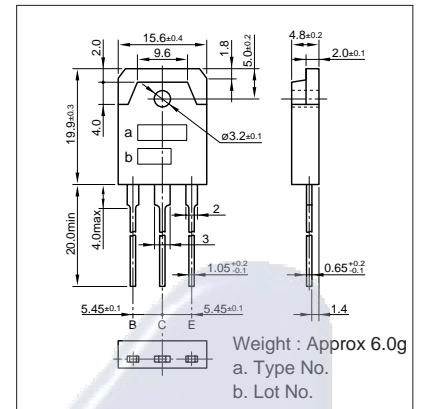

I_C-V_{CE} Characteristics (Typical)

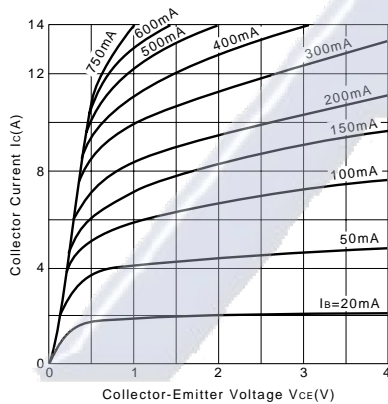

V_{CE(sat)}-I_B Characteristics (Typical)

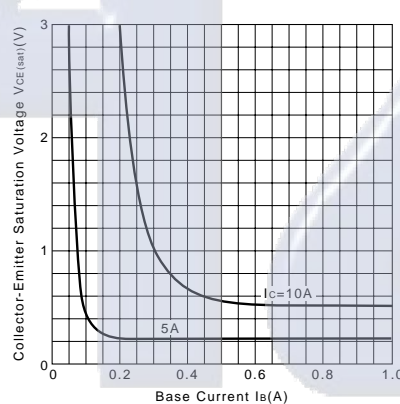

I_C-V_{BE} Temperature Characteristics (Typical)

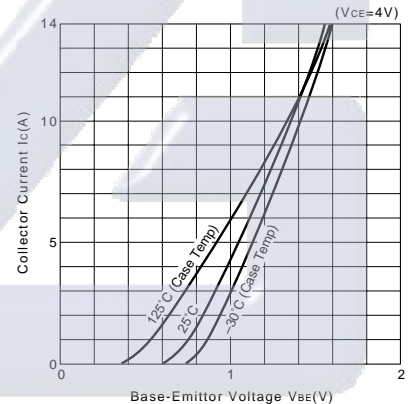

h_{FE}-I_C Characteristics (Typical)

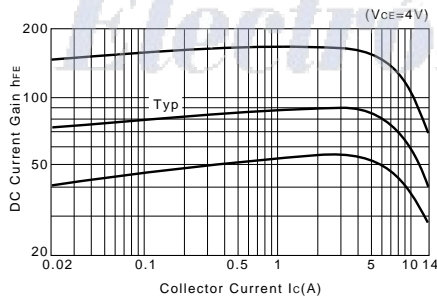

h_{FE}-I_C Temperature Characteristics (Typical)

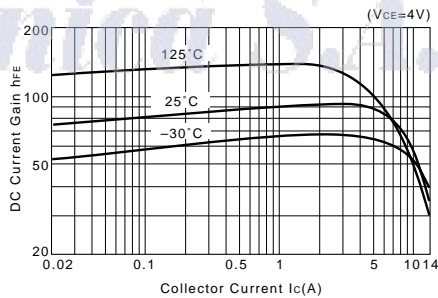

θ_{j-a}-t Characteristics

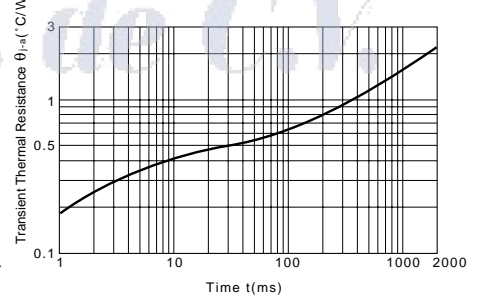

f_r-I_E Characteristics (Typical)

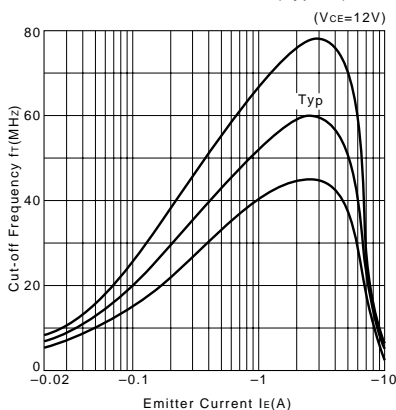

Safe Operating Area (Single Pulse)

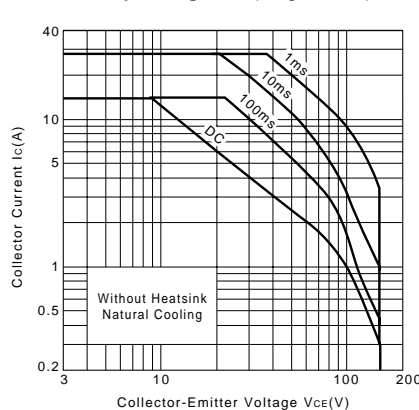

P_C-T_a Derating

