

## N-CHANNEL SILICON POWER MOS-FET

## F-II SERIES

### Features

- High speed switching
- Low on-resistance
- No secondary breakdown
- Low driving power
- High voltage
- $V_{GS} = \pm 30V$  Guarantee
- Avalanche-proof

### Applications

- Switching regulators
- UPS
- DC-DC converters
- General purpose power amplifier

### Max. Ratings and Characteristics

● Absolute Maximum Ratings ( $T_c = 25^\circ C$ ) :

Items	Symbols	Ratings	Units
Drain-source voltage	$V_{DSS}$	500	V
Continuous drain current	$I_D$	10	A
Pulsed drain current	$I_{D(puls)}$	30	A
Continuous reverse drain current	$I_{DR}$	10	A
Gate-source peak voltage	$V_{GSS}$	$\pm 30$	V
Max. power dissipation	$P_D$	50	W
Operating and storage temperature range	$T_{ch}$	150	$^\circ C$
	$T_{stg}$	$-55 \sim +150$	$^\circ C$

● Electrical Characteristics ( $T_c = 25^\circ C$ )

Items	Symbols	Test Conditions	Min.	Typ.	Max.	Units
Drain-source breakdown voltage	$V_{(BR)DSS}$	$I_D = 1mA$ $V_{GS} = 0V$	500			V
Gate threshold voltage	$V_{GS(th)}$	$I_D = 1mA$ $V_{DS} = V_{GS}$	2.5	3.5	5.0	V
Zero gate voltage drain current	$I_{DSS}$	$V_{DS} = 500V$ $V_{GS} = 0V$	$T_{ch} = 25^\circ C$	10	500	$\mu A$
			$T_{ch} = 125^\circ C$	0.2	1.0	mA
Gate-source leakage current	$I_{GSS}$	$V_{GS} = \pm 30V$ $V_{DS} = 0V$		10	100	nA
Drain-source on-state resistance	$R_{DS(on)}$	$I_D = 5A$ $V_{GS} = 10V$		0.7	0.9	$\Omega$
Forward transconductance	$g_{fs}$	$I_D = 5A$ $V_{DS} = 25V$	4.0	6.5		S
Input capacitance	$C_{iss}$	$V_{DS} = 25V$		1200	1800	pF
Output capacitance	$C_{oss}$	$V_{GS} = 0V$		160	240	
Reverse transfer capacitance	$C_{rss}$	$f = 1MHz$		70	100	
Turn-on time $t_{on}$ ( $t_{on} + t_{d(on)} + t_r$ )	$t_{d(on)}$	$V_{CC} = 300V$ $I_D = 10A$ $V_{GS} = 10V$ $R_G = 25\Omega$		30	45	ns
	$t_r$			80	120	
Turn-off time $t_{off}$ ( $t_{d(off)} + t_f$ )	$t_{d(off)}$			160	240	
	$t_f$			80	120	
Diode forward on-voltage	$V_{SD}$	$I_F = 2 \times I_{DR}$ $V_{GS} = 0V$ $T_{ch} = 25^\circ C$		1.10	1.5	V
Reverse recovery time	$t_{rr}$	$I_F = I_{DR}$ $d_i/d_r = 100A/\mu s$ $T_{ch} = 25^\circ C$		500		ns

● Thermal Characteristics

Items	Symbols	Test Conditions	Min.	Typ.	Max.	Units
Thermal Resistance	$R_{th(ch-a)}$	channel to air			62.5	$^\circ C/W$
	$R_{th(ch-c)}$	channel to case			2.5	$^\circ C/W$

### Outline Drawings

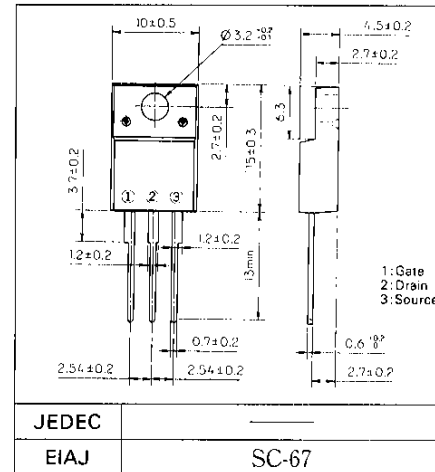

### Equivalent Circuit Schematic

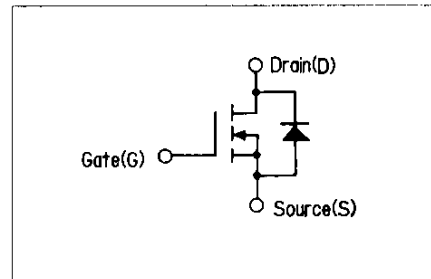

■ Characteristics

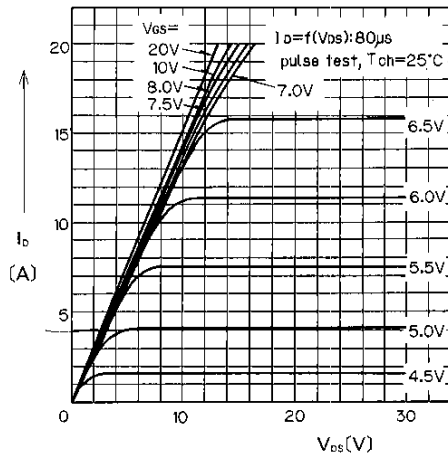

Typical Output Characteristics

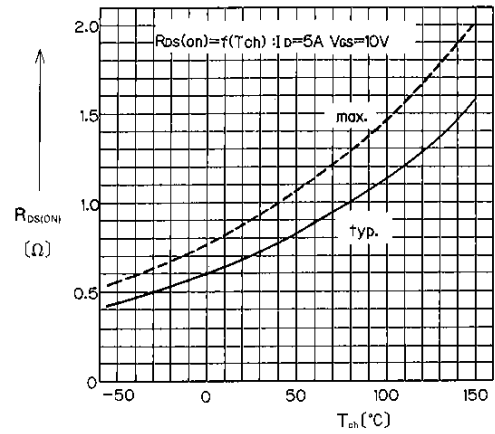

On State Resistance vs.  $T_{ch}$

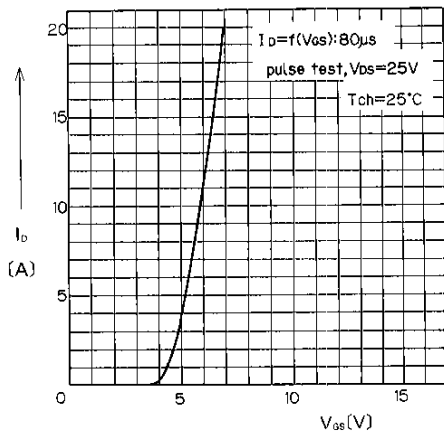

Typical Transfer Characteristics

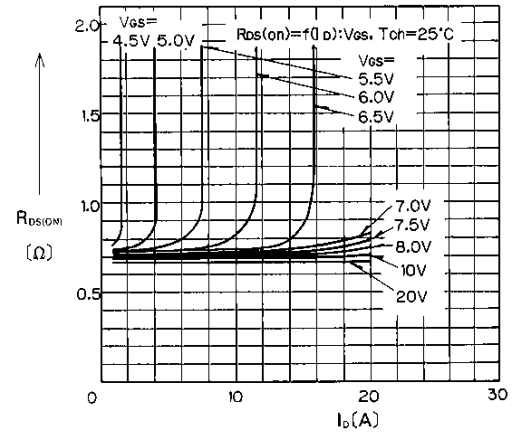

Typical Drain-Source on State Resistance vs.  $I_D$

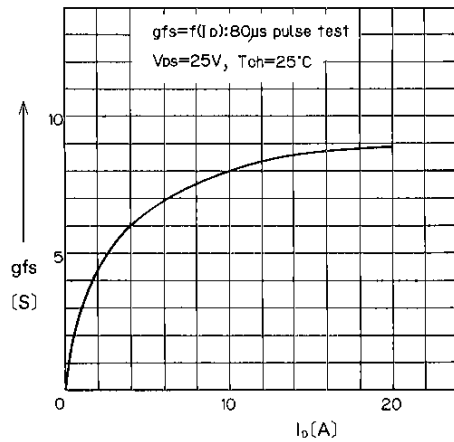

Typical Forward Transconductance vs.  $I_D$

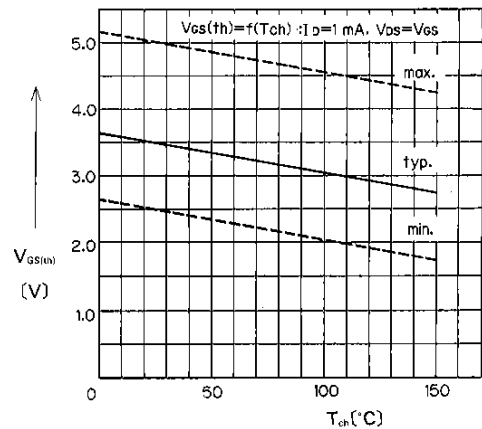

Gate Threshold Voltage vs.  $T_{ch}$

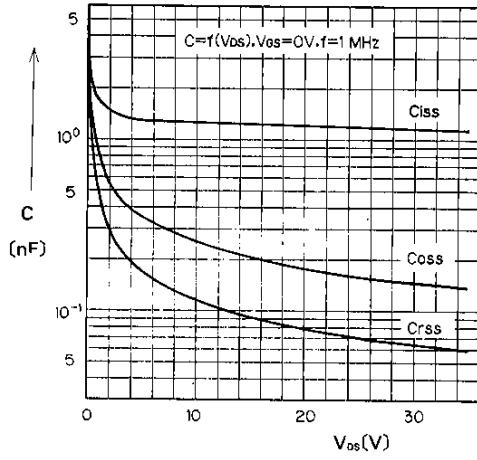

Typical Capacitance vs.  $V_{bs}$

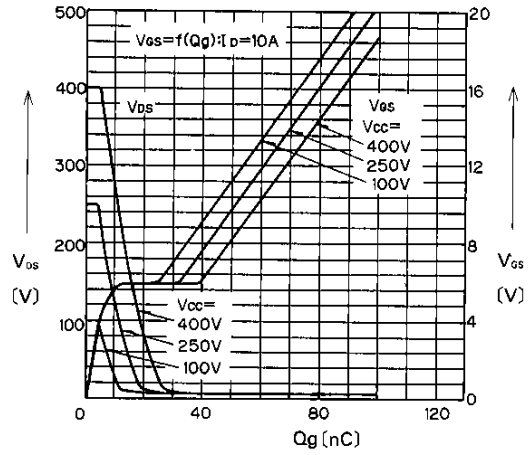

Typical Input Charge

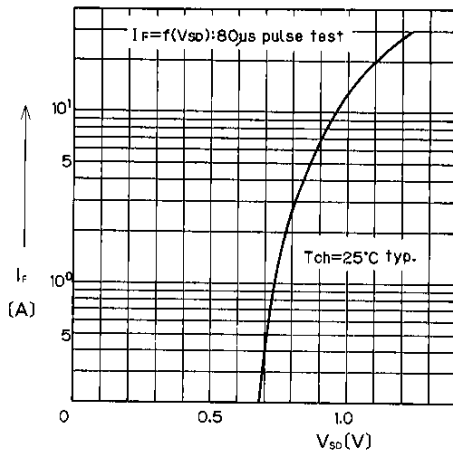

Forward Characteristic of Reverse Diode

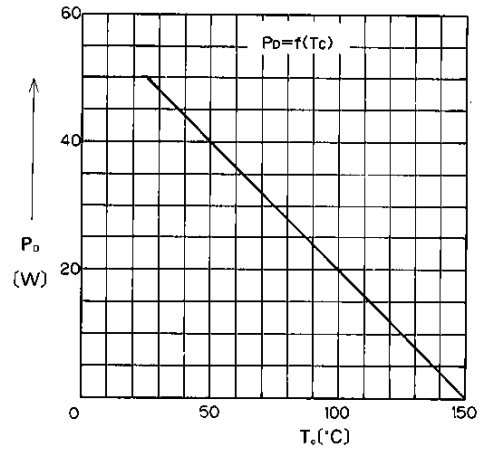

Allowable Power Dissipation vs.  $T_c$

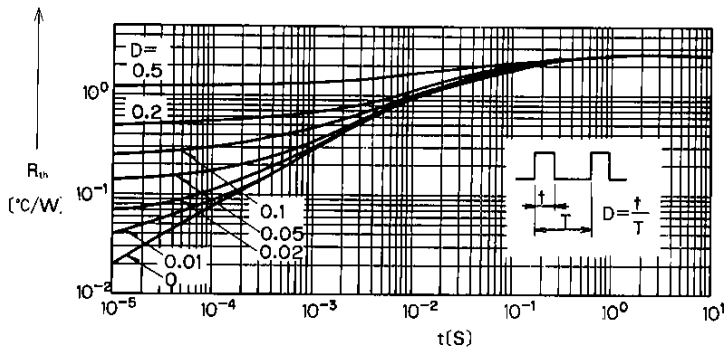

Transient Thermal Impedance

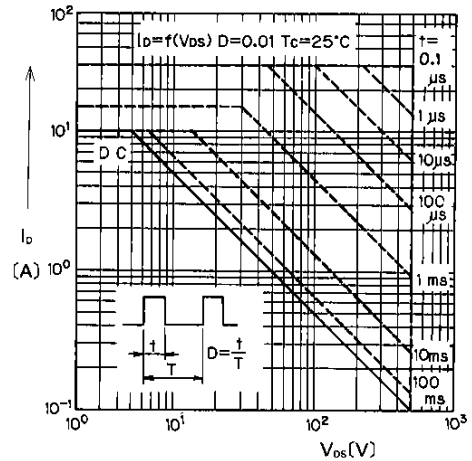

Safe Operating Area