

**TOSHIBA****2SK246**

TOSHIBA FIELD EFFECT TRANSISTOR SILICON N CHANNEL JUNCTION TYPE

**2SK246**

FOR CONSTANT CURRENT, IMPEDANCE

Unit in mm

CONVERTER AND DC-AC HIGH INPUT

IMPEDANCE AMPLIFIER CIRCUIT APPLICATIONS

- High Breakdown Voltage :  $V_{GDS} = -50V$
- High Input Impedance :  $I_{GSS} = 1nA$  (Max.) ( $V_{GS} = -30V$ )

MAXIMUM RATINGS ( $T_a = 25^\circ C$ )

CHARACTERISTIC	SYMBOL	RATING	UNIT
Gate-Drain Voltage	$V_{GDS}$	-50	V
Gate Current	$I_G$	10	mA
Drain Power Dissipation	$P_D$	300	mW
Junction Temperature	$T_j$	125	$^\circ C$
Storage Temperature Range	$T_{stg}$	-55~125	$^\circ C$

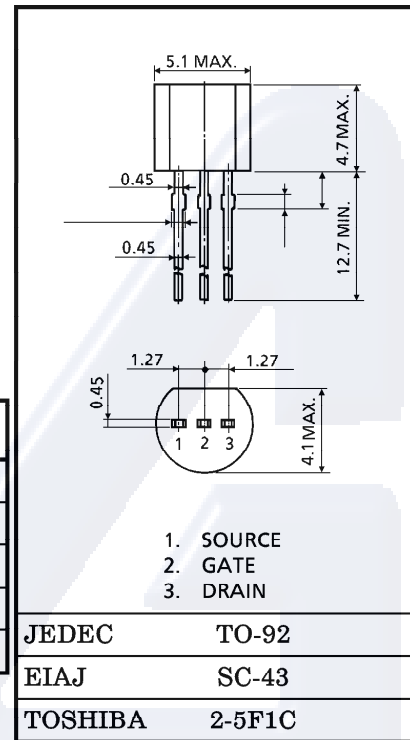

Weight : 0.21g

ELECTRICAL CHARACTERISTICS ( $T_a = 25^\circ C$ )

CHARACTERISTIC	SYMBOL	TEST CONDITION	MIN.	TYP.	MAX.	UNIT
Gate Cut-off Current	$I_{GSS}$	$V_{GS} = -30V, V_{DS} = 0$	—	—	-1.0	nA
Gate-Drain Breakdown Voltage	$V_{(BR)GDS}$	$V_{DS} = 0, I_G = -100\mu A$	-50	—	—	V
Drain Current	$I_{DSS}$ (Note)	$V_{DS} = 10V, V_{GS} = 0$	1.2	—	14	mA
Gate-Source Cut-off Voltage	$V_{GS(OFF)}$	$V_{DS} = 10V, I_D = 0.1\mu A$	-0.7	—	-6.0	V
Forward Transfer Admittance	$ Y_{fs} $	$V_{DS} = 10V, V_{GS} = 0, f = 1kHz$	1.5	—	—	mS
Input Capacitance	$C_{iss}$	$V_{DS} = 10V, V_{GS} = 0, f = 1MHz$	—	9.0	—	pF
Reverse Transfer Capacitance	$C_{rss}$	$V_{DG} = 10V, I_D = 0, f = 1MHz$	—	2.5	—	pF

Note :  $I_{DSS}$  Classification Y : 1.2~3.0mA, GR : 2.6~6.5mA, BL : 6~14mA

961001EAA2

- TOSHIBA is continually working to improve the quality and the reliability of its products. Nevertheless, semiconductor devices in general can malfunction or fail due to their inherent electrical sensitivity and vulnerability to physical stress. It is the responsibility of the buyer, when utilizing TOSHIBA products, to observe standards of safety, and to avoid situations in which a malfunction or failure of a TOSHIBA product could cause loss of human life, bodily injury or damage to property. In developing your designs, please ensure that TOSHIBA products are used within specified operating ranges as set forth in the most recent products specifications. Also, please keep in mind the precautions and conditions set forth in the TOSHIBA Semiconductor Reliability Handbook.
- The information contained herein is presented only as a guide for the applications of our products. No responsibility is assumed by TOSHIBA CORPORATION for any infringements of intellectual property or other rights of the third parties which may result from its use. No license is granted by implication or otherwise under any intellectual property or other rights of TOSHIBA CORPORATION or others.
- The information contained herein is subject to change without notice.

1997-04-10 1/3

### STATIC CHARACTERISTICS

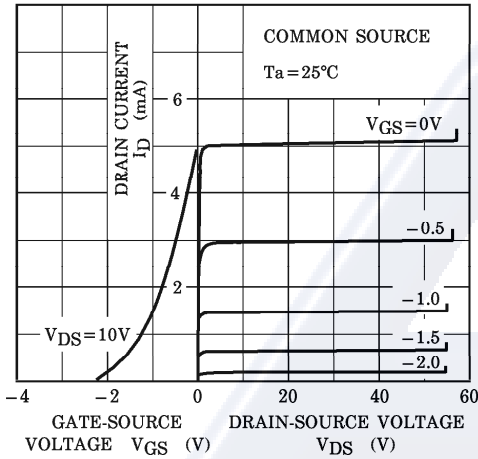

### I<sub>D</sub> - V<sub>GS</sub>

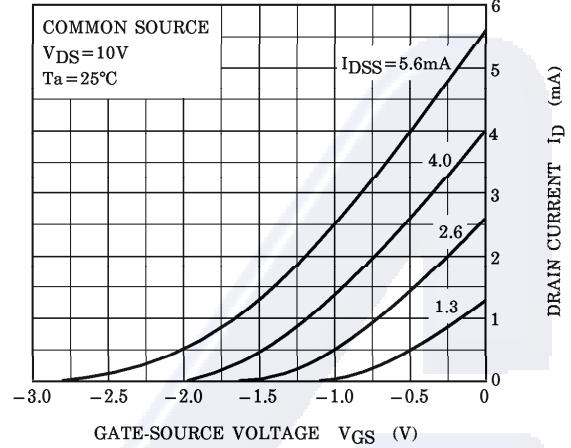

### I<sub>D</sub> - V<sub>DS</sub> (LOW VOLTAGE REGION)

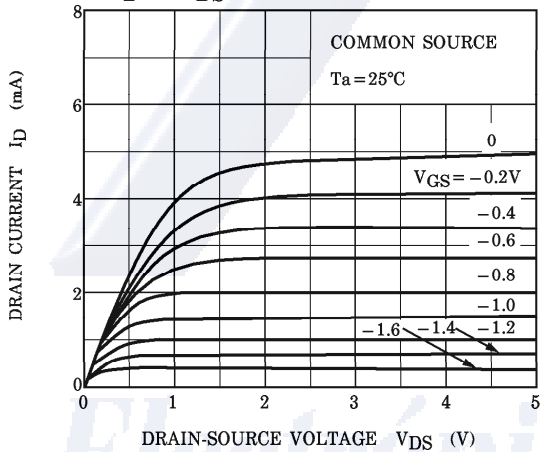

### |Y<sub>fs</sub>| - I<sub>D</sub>

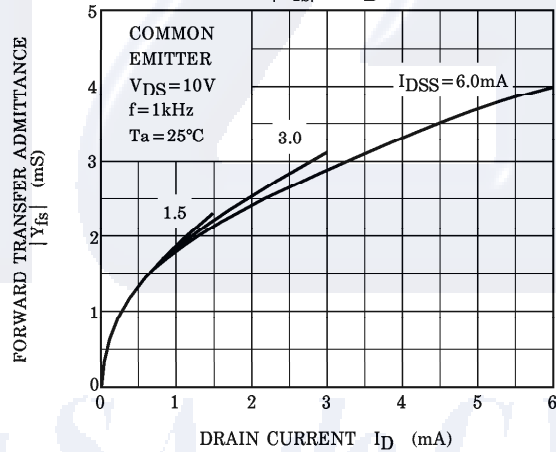

### C<sub>iss</sub> - V<sub>DS</sub>

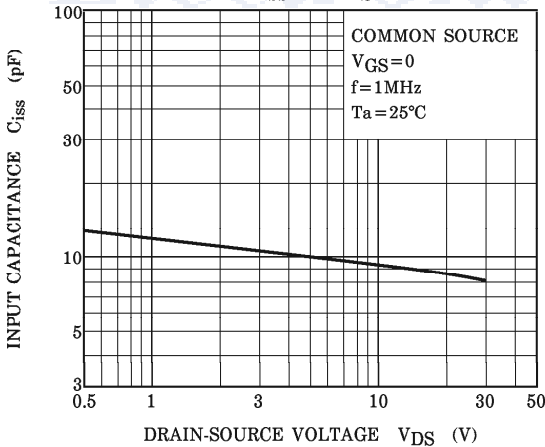

### C<sub>rss</sub> - V<sub>GD</sub>

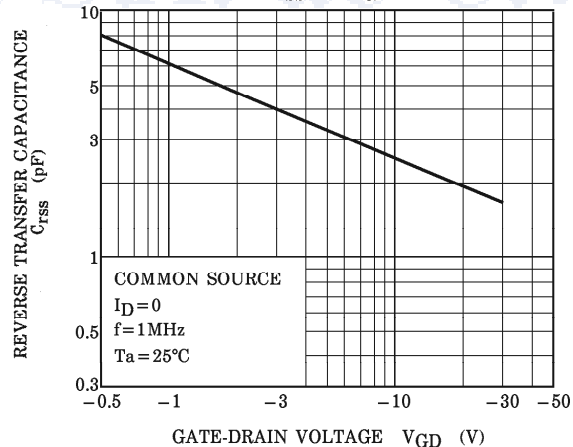

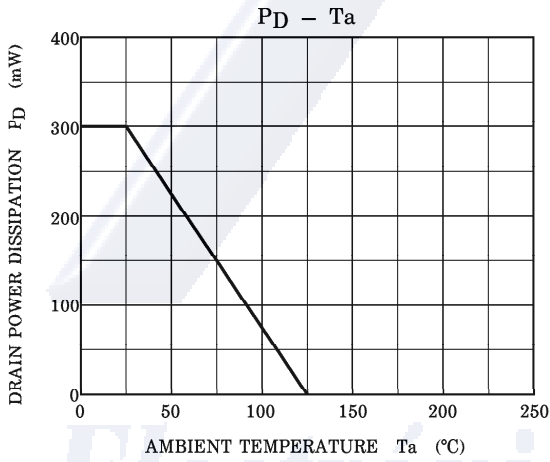
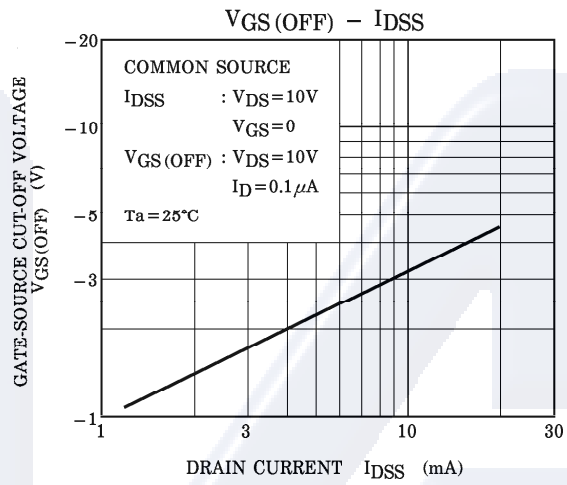
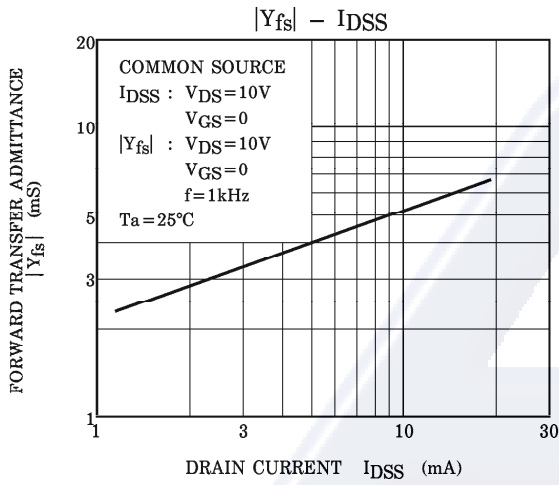

Electrónica S.A. de C.V.