

Type 380LX / 382LX 85 °C High Capacitance, Snap-In Aluminum

2, 4 and 5 pin styles available



The excellent value of Type 380L/LX capacitors finds application in switching power supply input and output circuits and even motor drives where the high surface area of multiple units in parallel approaches the ripple capability of our Type 520C computer-grade capacitor. Type 380LX delivers more capacitance per can size while Type 380L available in the largest case sizes gives lower ESR for the same capacitance. Types 382L and 382LX give the choice of 4 or 5 leads for stable, reverse proof mounting.

Highlights

- Latest available ratings, worldwide
- Top performance in power supplies and motor drives
- Big selection of 49 case sizes
- 2, 4 and 5 leads available

Specifications

Temperature Range	-40 °C to +85 °C ≤ 250 Vdc -25 °C to +85 °C ≥ 315 Vdc																															
Rated Voltage Range	16 Vdc to 500 Vdc																															
Capacitance Range	33 µF to 270,000 µF																															
Capacitance Tolerance	± 20%																															
Leakage Current	≤ 3√CV µA at 5 min																															
Ripple Current Multipliers	<p>Ambient Temperature</p> <table border="1"> <thead> <tr> <th></th> <th>45 °C</th> <th>60 °C</th> <th>70 °C</th> <th>85 °C</th> </tr> </thead> <tbody> <tr> <td></td> <td>1.5</td> <td>1.4</td> <td>1.3</td> <td>1.0</td> </tr> </tbody> </table> <p>Frequency</p> <table border="1"> <thead> <tr> <th></th> <th>50 Hz</th> <th>60 Hz</th> <th>120 Hz</th> <th>500 kHz</th> <th>1 kHz</th> <th>10 kHz & Up</th> </tr> </thead> <tbody> <tr> <td>16 - 100 WV</td> <td>0.93</td> <td>0.95</td> <td>1.00</td> <td>1.05</td> <td>1.08</td> <td>1.15</td> </tr> <tr> <td>160 - 450 WV</td> <td>0.75</td> <td>0.80</td> <td>1.00</td> <td>1.20</td> <td>1.25</td> <td>1.40</td> </tr> </tbody> </table>		45 °C	60 °C	70 °C	85 °C		1.5	1.4	1.3	1.0		50 Hz	60 Hz	120 Hz	500 kHz	1 kHz	10 kHz & Up	16 - 100 WV	0.93	0.95	1.00	1.05	1.08	1.15	160 - 450 WV	0.75	0.80	1.00	1.20	1.25	1.40
	45 °C	60 °C	70 °C	85 °C																												
	1.5	1.4	1.3	1.0																												
	50 Hz	60 Hz	120 Hz	500 kHz	1 kHz	10 kHz & Up																										
16 - 100 WV	0.93	0.95	1.00	1.05	1.08	1.15																										
160 - 450 WV	0.75	0.80	1.00	1.20	1.25	1.40																										
Low Temperature Characteristics	Impedance ratio: $Z_{-20°C} / Z_{+25°C}$ ≤ 8 (16-50 Vdc) ≤ 4 (63-100 Vdc) ≤ 3 (150-500 Vdc)																															
Endurance Life Test	3,000 h @ full load at +85 °C Δ Capacitance ±20% ESR 200% of limit DCL 100% of limit																															
Shelf Life Test	1,000 h @ 85 °C Δ Capacitance ±20% ESR 200% of limit DCL 100% of limit																															
Vibration	10 to 55 Hz, 0.06" and 10 g max, 2 h in each plane																															
RoHS Compliant																																

Type 380LX / 382LX 85 °C High Capacitance, Snap-In Aluminum

2, 4 and 5 pin styles available

Part Numbering System

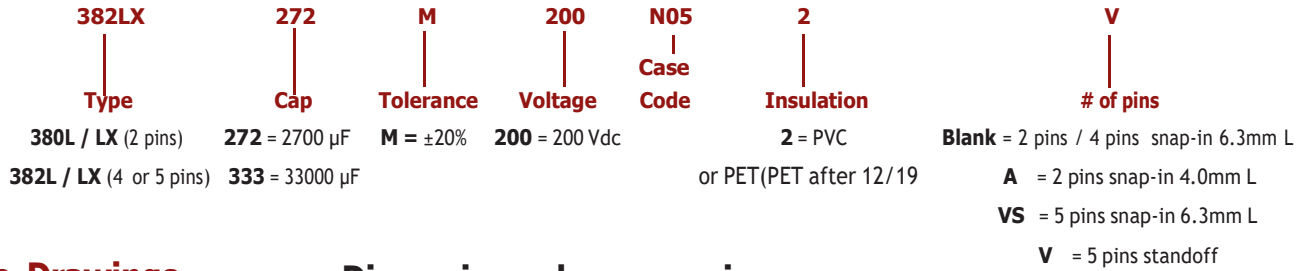

Outline Drawings

Two Pins

380L/LX (22 through 40 mm diameter)

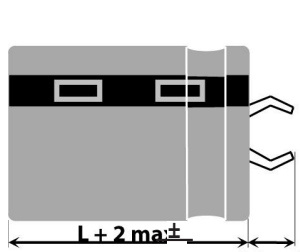

Four Pin ;
382L/LX (35, 40 and 45mm diameter)

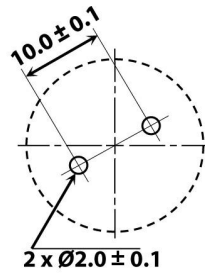
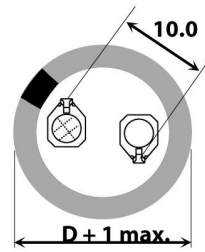

PC Board Mounting Holes

Available in 2, 4 and 5 pins

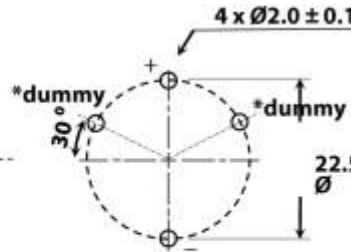
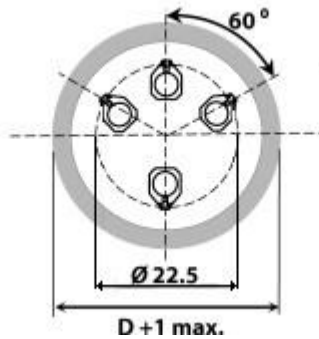
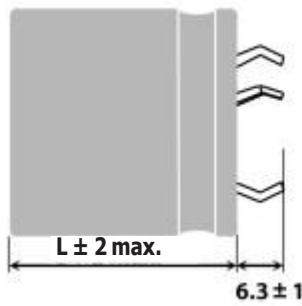
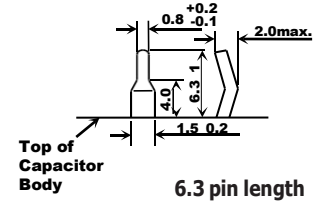

PC Board Mounting Holes

Available in 2 and 4 pins

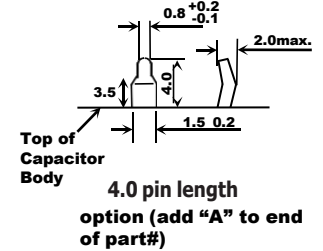

4.0 pin length
option (add "A" to end
of part#)

Five Pins

382L/LX (40 and 50mm diameter)

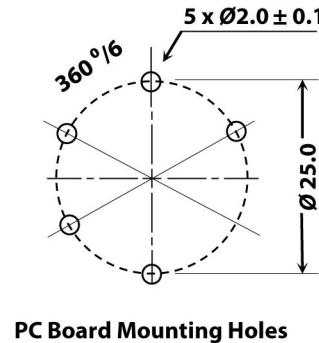
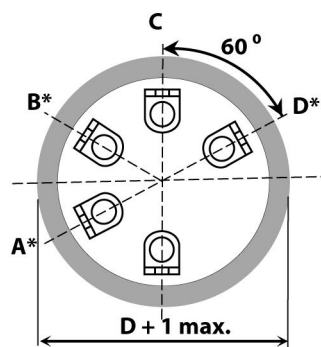
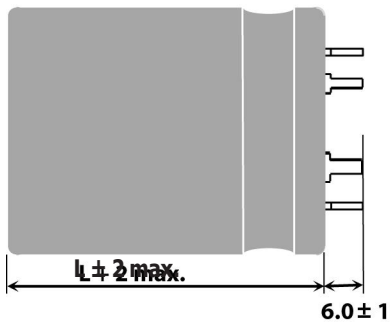

PC Board Mounting Holes

Available in 5 pins

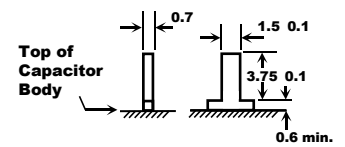

5 pin Standoff pin
style (add "V" to end
of part#)

Terminal	Connection	
	40 mm Dia.	50 mm Dia.
A	dummy	negative (-)
B	dummy	dummy
C	positive (+)	positive (+)
D	dummy	positive (+)
-	negative (-)	negative (-)

Notes:

* Use dummy terminals for mechanical support only. Make no electrical connection because they resistively connect through the electrolyte to the negative terminal.

** Safety Vent may be on the bottom or on the side of the can.

Type 380LX / 382LX 85 °C High Capacitance, Snap-In Aluminum

2, 4 and 5 pin styles available

Insulated Case Dimensions

Case Code	DIAMETER "D"		LENGTH "L"		Typical Weight (grams)
	mm	inches	mm	inches	
H20	22	0.87	20	0.79	14
H01	22	0.87	25	0.98	16
H02	22	0.87	30	1.18	19
H03	22	0.87	35	1.38	22
H04	22	0.87	40	1.57	24
H45	22	0.87	45	1.77	28
H05	22	0.87	50	1.97	31
J20	25	0.98	20	0.79	16
J01	25	0.98	25	0.98	20
J02	25	0.98	30	1.18	24
J03	25	0.98	35	1.38	27
J04	25	0.98	40	1.57	31
J45	25	0.98	45	1.77	35
J05	25	0.98	50	1.97	38
K20	30	1.18	20	0.79	25
K01	30	1.18	25	0.98	30
K02	30	1.18	30	1.18	35
K03	30	1.18	35	1.38	40
K04	30	1.18	40	1.57	44
K45	30	1.18	45	1.77	48
K05	30	1.18	50	1.97	53
A20	35	1.38	20	0.79	35
A01	35	1.38	25	0.98	42
A02	35	1.38	30	1.18	48
A03	35	1.38	35	1.38	54

Case Code	DIAMETER "D"		LENGTH "L"		Typical Weight (grams)
	mm	inches	mm	inches	
A04	35	1.38	40	1.57	62
A45	35	1.38	45	1.77	67
A05	35	1.38	50	1.97	74
A55	35	1.38	55	2.17	80
A06	35	1.38	63	2.48	88
A07	35	1.38	70	2.76	98
A08	35	1.38	80	3.15	112
A10	35	1.38	105	4.13	144
N04	40	1.57	40	1.57	82
N05	40	1.57	50	1.97	105
N06	40	1.57	63	2.48	130
N08	40	1.57	80	3.15	185
N10	40	1.57	105	4.13	265
E05	45	1.77	50	1.97	122
E06	45	1.77	63	2.48	150
E75	45	1.77	75	2.65	200
E08	45	1.77	80	3.15	213
E09	45	1.77	92	3.62	238
E10	45	1.77	105	4.13	299
B05	50	1.97	50	1.97	136
B06	50	1.97	63	2.48	168
B08	50	1.97	80	3.15	239
B09	50	1.97	92	3.62	241
B10	50	1.97	105	4.13	325

Typical Performance Curves

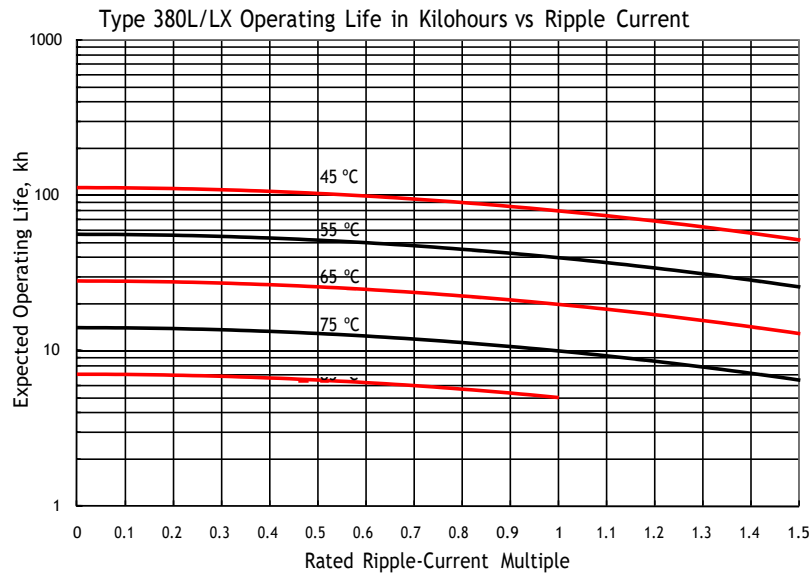

Type 380LX / 382LX 85 °C High Capacitance, Snap-In Aluminum

2, 4 and 5 pin styles available

Typical Performance Curves

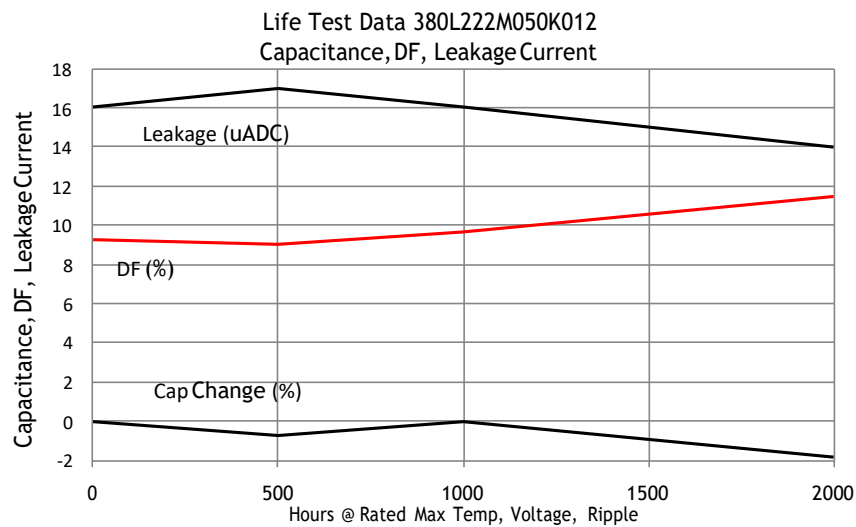
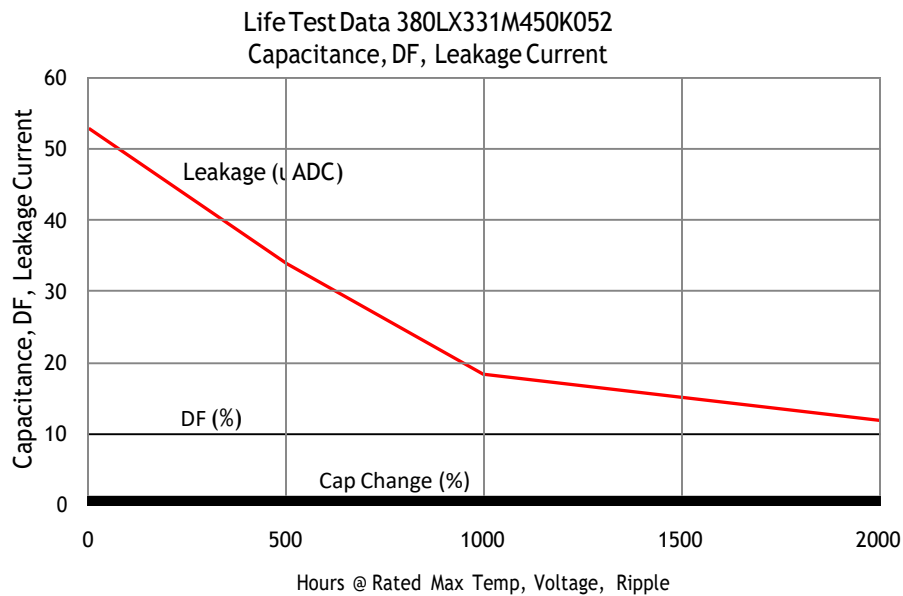
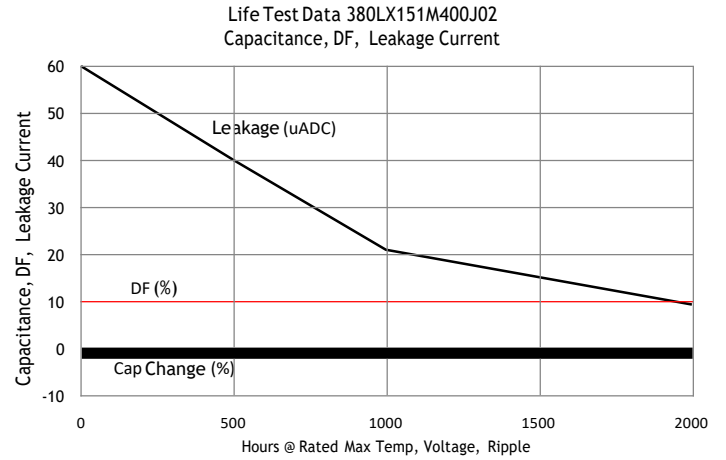
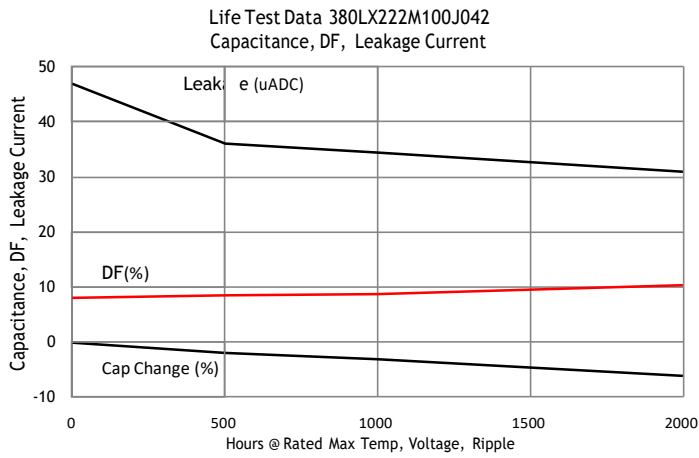

Type 380LX / 382LX 85 °C High Capacitance, Snap-In Aluminum

2, 4 and 5 pin styles available

Cap. (µF)	Catalog Part Number	Max. ESR		Ripple Amps		Nominal Size D x L (mm)
		@ +25°C		@ +85°C		
		120 Hz (ohms)	20 kHz (ohms)	120 Hz (A)	20 kHz (A)	
35 Vdc (44 Vdc Surge)						
6800	380LX682M035J022	0.073	0.055	2.60	2.99	25 x 30
8200	380LX822M035J022	0.071	0.053	3.26	3.75	25 x 30
8200	380LX822M035J032	0.057	0.043	4.00	4.60	25 x 35
10000	380LX103M035H452	0.050	0.037	4.40	5.10	22 x 45
10000	380LX103M035J022	0.058	0.044	4.42	5.08	25 x 30
10000	380LX103M035A012	0.050	0.037	4.40	5.10	35 x 25
12000	380LX123M035J042	0.048	0.036	5.05	5.81	25 x 40
15000	380LX153M035J052	0.036	0.027	5.60	6.40	25 x 50
15000	380LX153M035K042	0.036	0.027	5.60	6.40	30 x 40
15000	380LX153M035A022	0.036	0.027	5.60	6.40	35 x 30
18000	380LX183M035K452	0.480	0.037	5.70	6.50	30 x 45
18000	380LX183M035A032	0.480	0.037	5.70	6.50	35 x 35
22000	380LX223M035K452	0.026	0.020	6.10	7.02	30 x 45
22000	380LX223M035A042	0.026	0.020	6.10	7.00	35 x 40
27000	380LX273M035A452	0.021	0.017	6.80	7.90	35 x 45
27000	380LX273M035A052	0.021	0.016	6.84	7.87	35 x 50
33000	380LX333M035A052	0.018	0.014	7.15	8.22	35 x 50
39000	380LX393M035A052	0.017	0.014	7.91	9.10	35 x 50
39000	382LX393M035N052	0.017	0.014	8.00	9.20	40 x 50
47000	380LX473M035A552	0.014	0.014	8.56	9.84	35 x 55
47000	382LX473M035N062	0.016	0.013	9.60	11.00	40 x 63
56000	382LX563M035N082	0.015	0.012	10.30	11.90	40 x 80
56000	382LX563M035B052V	0.015	0.012	10.94	12.58	50 x 50
68000	380LX683M035A102	0.010	0.008	9.50	11.00	35 x 105
68000	382LX683M035B062V	0.013	0.011	11.93	13.72	50 x 63
82000	382LX823M035N102	0.012	0.009	12.02	13.82	40 x 105
82000	382LX823M035B082V	0.012	0.010	13.06	15.02	50 x 80
100000	382LX104M035B092V	0.011	0.009	13.97	16.07	50 x 92
120000	382LX124M035B102V	0.010	0.008	14.86	17.09	50 x 105
50 Vdc (63 Vdc Surge)						
1500	380LX152M050H012	0.220	0.170	1.25	1.45	22 x 25
2200	380LX222M050H012	0.150	0.115	1.80	2.10	22 x 25
2700	380LX272M050H012	0.154	0.115	2.20	2.60	22 x 25
3300	380LX332M050H012	0.151	0.113	2.41	2.77	22 x 25
3300	380LX332M050H022	0.100	0.075	2.70	3.10	22 x 30
3300	380LX332M050J012	0.100	0.075	2.70	3.10	25 x 25
3900	380LX392M050J012	0.085	0.065	2.80	3.20	25 x 25
4700	380LX472M050H032	0.070	0.055	3.00	3.50	22 x 35
4700	380LX472M050J012	0.080	0.060	2.10	2.40	25 x 25
4700	380LX472M050J022	0.070	0.055	3.00	3.50	25 x 30
4700	380LX472M050K012	0.070	0.055	3.00	3.50	30 x 25

Cap. (µF)	Catalog Part Number	Max. ESR		Ripple Amps		Nominal Size D x L (mm)
		@ +25°C		@ +85°C		
		120 Hz (ohms)	20 kHz (ohms)	120 Hz (A)	20 kHz (A)	
50 Vdc (63 Vdc Surge)						
5600	380LX562M050J032	0.060	0.045	3.40	3.90	25 x 35
5600	380LX562M050K022	0.060	0.045	3.40	3.90	30 x 30
6800	380LX682M050H452	0.073	0.055	3.85	4.43	22 x 45
8200	380LX822M050J452	0.067	0.050	4.40	5.10	25 x 45
8200	380LX822M050K032	0.067	0.050	4.40	5.10	30 x 35
10000	380LX103M050J052	0.040	0.030	5.00	5.70	25 x 50
10000	380LX103M050K042	0.040	0.030	5.00	5.70	30 x 40
10000	380LX103M050A022	0.040	0.030	5.00	5.70	35 x 30
12000	380LX123M050K452	0.033	0.025	5.60	6.40	30 x 45
12000	380LX123M050A032	0.041	0.031	5.58	6.42	35 x 35
15000	380LX153M050A452	0.027	0.020	6.40	7.40	35 x 45
18000	380LX183M050A452	0.028	0.021	6.94	7.98	35 x 45
18000	382LX183M050N042	0.023	0.017	6.94	7.98	40 x 40
22000	380L223M050A052	0.023	0.018	7.57	8.71	35 x 50
22000	380LX223M050A052	0.025	0.020	7.60	8.71	35 x 50
27000	380L273M050A052	0.018	0.015	8.96	10.03	35 x 50
27000	382LX273M050N052	0.018	0.015	8.10	9.30	40 x 50
27000	382L273M050N062	0.018	0.009	9.00	9.60	40 x 63
33000	380LX333M050A082	0.015	0.012	9.20	10.60	35 x 80
33000	382LX333M050N062	0.018	0.014	9.10	10.50	40 x 63
33000	382LX333M050B052V	0.018	0.014	10.48	12.05	50 x 50
47000	380LX473M050A102	0.014	0.011	10.27	11.81	35 x 105
47000	382LX473M050B062V	0.013	0.010	11.54	13.27	50 x 63
56000	382LX563M050N102	0.012	0.009	11.47	13.19	40 x 105
56000	382LX563M050B082V	0.012	0.009	12.46	14.33	50 x 80
68000	382LX683M050B092V	0.011	0.009	13.17	15.15	50 x 92
82000	382LX823M050B102V	0.011	0.008	13.87	15.95	50 x 105
63 Vdc (79 Vdc Surge)						
1000	380LX102M063H012	0.332	0.250	1.20	1.40	22 x 25
1500	380LX152M063H012	0.221	0.167	1.70	2.00	22 x 25
2200	380LX222M063J012	0.151	0.114	2.50	2.90	25 x 25
2700	380LX272M063H042	0.126	0.094	2.72	3.13	22 x 40
3300	380LX332M063J022	0.106	0.080	3.13	3.60	25 x 30
3900	380LX392M063J022	0.106	0.080	3.13	3.60	25 x 30
4700	380LX472M063J032	0.080	0.060	3.99	4.56	25 x 35
4700	380LX472M063K022	0.080	0.060	4.90	5.60	30 x 30
4700	380LX472M063A012	0.080	0.060	4.90	5.60	35 x 25
5600	380LX562M063K022	0.070	0.050	4.11	4.72	30 x 30
6800	380LX682M063J052	0.060	0.045	5.80	6.70	25 x 50
6800	380LX682M063K042	0.060	0.045	5.80	6.70	30 x 40
8200	380LX822M063A032	0.050	0.040	6.00	6.90	35 x 35
10000	380LX103M063A042	0.033	0.025	6.50	7.50	35 x 40

Type 380LX / 382LX 85 °C High Capacitance, Snap-In Aluminum

2, 4 and 5 pin styles available

Cap. (uF)	Catalog Part Number	Max. ESR		Ripple Amps		Nominal Size D x L (mm)
		@ +25°C		@ +85°C		
		120 Hz (ohms)	20 kHz (ohms)	120 Hz (A)	20 kHz (A)	
63 Vdc (79 Vdc Surge)						
10000	382L103M063N042	0.028	0.017	6.60	7.20	40 x 40
12000	380LX123M063K052	0.035	0.026	7.15	8.22	30 x 50
12000	382LX123M063N042	0.035	0.028	7.15	8.22	40 x 40
15000	380LX153M063A052	0.028	0.021	7.91	9.10	35 x 50
18000	380LX183M063A082	0.023	0.012	9.40	10.80	35 x 80
18000	382LX183M063N062	0.028	0.022	9.25	10.60	40 x 63
27000	380LX273M063A102	0.015	0.012	10.38	11.94	35 x 105
27000	382LX273M063N082	0.018	0.015	10.00	11.50	40 x 80
27000	382LX273M063B052V	0.018	0.015	10.86	12.49	50 x 50
33000	382LX333M063N102	0.015	0.012	11.76	13.52	40 x 105
33000	382LX333M063B062V	0.017	0.013	11.57	13.42	50 x 63
47000	382LX473M063B082V	0.013	0.010	12.78	14.70	50 x 80
51000	382LX513M063B092V	0.012	0.010	13.34	15.34	50 x 92
56000	382LX563M063B102V	0.012	0.009	13.93	16.02	50 x 105
80 Vdc (100 Vdc Surge)						
680	380LX681M080H012	0.390	0.295	1.00	1.20	22 x 25
1000	380LX102M080H012	0.265	0.200	1.50	1.75	22 x 25
1200	380LX122M080H022	0.235	0.176	1.80	2.10	22 x 30
1500	380LX152M080H022	0.177	0.134	2.30	2.60	22 x 30
1500	380LX152M080K202	0.200	0.150	1.40	1.60	30 x 20
1800	380LX182M080J032	0.147	0.109	2.50	2.90	25 x 35
2200	380LX222M080H452	0.121	0.092	2.70	3.10	22 x 45
2200	380LX222M080K012	0.121	0.092	2.70	3.10	30 x 25
2700	380LX272M080J042	0.123	0.092	2.78	3.20	25 x 40
3300	380LX332M080J042	0.100	0.075	3.21	3.69	25 x 40
3300	380LX332M080K022	0.085	0.065	3.20	3.70	30 x 30
3900	380LX392M080J452	0.080	0.060	3.60	4.10	25 x 45
3900	380LX392M080K042	0.085	0.064	3.59	4.13	30 x 40
4700	380LX472M080J052	0.065	0.050	4.10	4.70	25 x 50
4700	380LX472M080K042	0.071	0.053	4.09	4.70	30 x 40
5600	380LX562M080K452	0.059	0.044	4.55	5.23	30 x 45
5600	380LX562M080A032	0.055	0.040	4.60	5.20	35 x 35
6800	380LX682M080K052	0.049	0.037	5.16	5.93	30 x 50
6800	380LX682M080A042	0.045	0.035	5.20	5.90	35 x 40
8200	380LX822M080A052	0.040	0.030	5.80	6.70	35 x 50
8200	382LX822M080N042	0.040	0.030	5.83	6.70	40 x 40
10000	380LX103M080A052	0.033	0.025	6.40	7.34	35 x 50
12000	380L123M080A072	0.020	0.012	8.10	9.00	35 x 70
12000	382L123M080N052	0.025	0.016	7.50	8.00	40 x 50
15000	380L153M080A082	0.017	0.010	8.80	9.60	35 x 80
15000	382L153M080N062	0.020	0.013	8.50	9.20	40 x 63
18000	382L183M080N082	0.014	0.009	10.30	10.80	40 x 80

Cap. (uF)	Catalog Part Number	Max. ESR		Ripple Amps		Nominal Size D x L (mm)
		@ +25°C		@ +85°C		
		120 Hz (ohms)	20 kHz (ohms)	120 Hz (A)	20 kHz (A)	
80 Vdc (100 Vdc Surge)						
18000	382LX183M080B052V	0.023	0.017	10.00	11.50	50 x 50
22000	380LX223M080A102	0.015	0.011	9.86	11.34	35 x 105
22000	382LX223M080B062V	0.019	0.014	11.08	12.74	50 x 63
27000	382LX273M080N102	0.015	0.012	11.35	13.05	40 x 105
27000	382LX273M080B082V	0.015	0.012	12.33	14.18	50 x 80
33000	382LX333M080B092V	0.014	0.010	13.37	15.38	50 x 92
39000	382LX393M080B102V	0.013	0.010	14.34	16.49	50 x 105
100 Vdc (125 Vdc Surge)						
470	380LX471M100H012	0.450	0.300	1.10	1.30	22 x 25
560	380LX561M100H012	0.400	0.250	1.30	1.50	22 x 25
680	380LX681M100H012	0.100	0.250	1.30	1.50	22 x 25
1000	380LX102M100H022	0.220	0.150	2.00	2.30	22 x 30
1000	380LX102M100J012	0.220	0.150	2.00	2.30	25 x 25
1200	380LX122M100H032	0.195	0.125	1.80	2.70	22 x 35
1500	380LX152M100H042	0.155	0.100	2.60	3.00	22 x 40
1800	380LX182M100H042	0.140	0.090	2.80	3.30	22 x 40
2200	380LX222M100J042	0.121	0.080	3.14	3.61	25 x 40
2700	380LX272M100J452	0.104	0.068	3.70	4.30	25 x 45
2700	380LX272M100A022	0.092	0.060	3.71	4.27	35 x 30
3300	380LX332M100J052	0.090	0.060	4.10	4.70	25 x 50
3300	380LX332M100K042	0.090	0.060	4.10	4.70	30 x 40
3300	380LX332M100A022	0.100	0.065	4.07	4.68	35 x 30
3900	380LX392M100K452	0.080	0.050	4.50	5.20	30 x 45
3900	380LX392M100K052	0.085	0.055	4.54	5.22	30 x 50
4700	380LX472M100K052	0.071	0.046	5.13	5.90	30 x 50
4700	380LX472M100A042	0.070	0.050	5.10	5.90	35 x 40
5600	380LX562M100A052	0.059	0.041	5.75	6.61	35 x 50
5600	382LX562M100N042	0.060	0.045	5.80	6.60	40 x 40
6800	380LX682M100A052	0.049	0.034	6.60	7.59	35 x 50
6800	382L682M100N052	0.026	0.017	7.40	7.90	40 x 50
8200	382LX822M100N052	0.040	0.030	7.30	8.40	40 x 50
8200	382L822M100N062	0.021	0.013	8.40	9.10	40 x 63
10000	380LX103M100A082	0.033	0.025	8.70	9.60	35 x 80
10000	382LX103M100N062	0.033	0.025	8.00	9.20	40 x 63
10000	382LX103M100B052V	0.033	0.025	8.82	10.14	50 x 50
12000	380LX123M100A102	0.028	0.021	8.57	9.86	35 x 105
12000	382LX123M100N082	0.028	0.021	8.65	10.00	40 x 80
15000	382LX153M100N102	0.022	0.017	10.12	11.64	40 x 105
15000	382LX153M100B062V	0.022	0.017	10.07	11.58	50 x 63
18000	382LX183M100B082V	0.018	0.014	11.00	12.65	50 x 80
22000	382LX223M100B092V	0.015	0.011	11.76	13.52	50 x 92
27000	382LX273M100B102V	0.014	0.010	12.53	14.41	50 x 105

Type 380LX / 382LX 85 °C High Capacitance, Snap-In Aluminum

2, 4 and 5 pin styles available

Cap. (uF)	Catalog Part Number	Max. ESR @ +25°C		Ripple Amps @ +85°C		Nominal Size D x L (mm)
		120 Hz	20 kHz	120 Hz	20 kHz	
		(ohms)	(ohms)	(A)	(A)	
160 Vdc (200 Vdc Surge)						
220	380LX221M160H012	0.850	0.420	0.90	1.25	22 x 25
270	380LX271M160H012	0.700	0.340	1.20	1.65	22 x 25
330	380LX331M160H012	0.600	0.310	1.50	2.00	22 x 25
390	380LX391M160H012	0.470	0.240	1.60	2.30	22 x 25
470	380LX471M160H022	0.420	0.220	1.86	2.66	22 x 30
560	380LX561M160H032	0.360	0.180	2.25	3.15	22 x 35
680	380LX681M160H042	0.296	0.130	2.36	2.39	22 x 40
820	380LX821M160J042	0.243	0.109	2.75	3.85	25 x 40
1000	380LX102M160J042	0.220	0.110	3.00	4.20	25 x 40
1200	380LX122M160K032	0.210	0.115	3.25	4.55	30 x 35
1800	380LX182M160K052	0.140	0.085	4.20	5.90	30 x 50
2700	380LX272M160A052	0.086	0.043	5.30	7.42	35 x 50
2700	382LX272M160N042	0.080	0.045	5.50	7.60	40 x 40
4700	382L472M160N082	0.036	0.020	6.60	8.50	40 x 80
5600	382LX562M160N082	0.040	0.020	8.30	11.70	40 x 80
5600	382LX562M160B052V	0.040	0.020	8.25	9.50	50 x 50
6800	380LX682M160N102	0.038	0.021	8.90	12.46	40 x 105
8200	382LX822M160B062V	0.026	0.015	8.90	12.50	50 x 63
10000	382LX103M160N102	0.022	0.012	9.90	13.80	40 x 105
10000	382LX103M160B082V	0.022	0.012	9.80	13.70	50 x 80
12000	382LX123M160B092V	0.018	0.010	12.90	18.10	50 x 92
15000	382LX153M160B102V	0.014	0.008	14.10	19.70	50 x 105
180 Vdc (225 Vdc Surge)						
330	380LX331M180H012	0.603	0.308	1.50	2.00	22 x 25
390	380LX391M180H022	0.510	0.230	1.68	2.35	22 x 30
470	380LX471M180H022	0.423	0.190	1.91	2.67	22 x 30
560	380LX561M180H042	0.355	0.160	2.25	3.15	22 x 40
680	380LX681M180J032	0.293	0.132	2.22	3.11	25 x 35
820	380LX821M180K022	0.240	0.120	2.80	3.90	30 x 30
1000	380LX102M180J052	0.220	0.100	3.00	4.20	25 x 50
1200	380LX122M180J052	0.170	0.080	3.31	4.63	25 x 50
1500	380LX152M180K052	0.130	0.070	3.80	5.40	30 x 50
1800	380LX182M180K052	0.120	0.050	4.32	6.05	30 x 50
2200	380LX222M180A052	0.090	0.050	4.90	6.90	35 x 50
2700	382L272M180N062	0.051	0.027	5.00	6.50	40 x 63
4700	382L472M180N082	0.036	0.020	6.60	8.50	40 x 80
200 Vdc (250 Vdc Surge)						
150	380LX151M200H012	1.330	0.600	0.65	0.90	22 x 25
220	380LX221M200H012	0.900	0.420	1.00	1.45	22 x 25
270	380LX271M200H012	0.730	0.300	1.40	2.00	22 x 25
330	380LX331M200H022	0.600	0.270	1.60	2.20	22 x 30
330	380LX331M200J012	0.470	0.210	1.70	2.40	25 x 25

Cap. (uF)	Catalog Part Number	Max. ESR @ +25°C		Ripple Amps @ +85°C		Nominal Size D x L (mm)
		120 Hz	20 kHz	120 Hz	20 kHz	
		(ohms)	(ohms)	(A)	(A)	
200 Vdc (250 Vdc Surge)						
390	380LX391M200H022	0.510	0.230	1.68	2.35	22 x 30
390	380LX391M200J012	0.470	0.210	1.70	2.40	25 x 25
470	380LX471M200J022	0.420	0.190	1.90	2.60	25 x 30
470	380LX471M200A202	0.460	0.210	1.30	1.80	35 x 20
560	380LX561M200H042	0.360	0.160	2.18	3.08	22 x 40
680	380LX681M200H452	0.290	0.130	2.70	3.80	22 x 45
680	380LX681M200J032	0.270	0.120	2.70	3.80	25 x 35
680	380LX681M200K022	0.270	0.120	2.70	3.80	30 x 30
820	380LX821M200H452	0.243	0.124	2.90	4.10	22 x 45
820	380LX821M200J042	0.240	0.110	2.60	3.60	25 x 40
820	380LX821M200K022	0.220	0.100	2.90	4.10	30 x 30
1000	380LX102M200J452	0.199	0.090	3.25	4.55	25 x 45
1000	380LX102M200K022	0.199	0.102	3.30	4.60	30 x 30
1000	380LX102M200K032	0.216	0.097	3.20	4.50	30 x 35
1200	380LX122M200J052	0.144	0.072	3.87	5.42	25 x 50
1200	380LX122M200K042	0.166	0.075	3.50	4.90	30 x 40
1200	380LX122M200A022	0.166	0.075	3.50	4.90	35 x 30
1500	380LX152M200K452	0.144	0.072	3.87	5.42	30 x 45
1500	380LX152M200A032	0.144	0.072	3.87	5.42	35 x 35
1800	380LX182M200K052	0.120	0.060	4.32	6.05	30 x 50
1800	380LX182M200A042	0.120	0.060	4.32	6.05	35 x 40
2200	380LX222M200A452	0.098	0.054	4.92	6.89	35 x 45
2200	382LX222M200N042	0.098	0.054	4.92	6.89	40 x 40
2700	380LX272M200A062	0.080	0.045	5.50	7.70	35 x 63
2700	382LX272M200N052	0.080	0.045	5.40	7.60	40 x 50
3300	380LX332M200A082	0.065	0.037	6.40	9.00	35 x 80
3300	382LX332M200N062	0.065	0.037	6.30	8.90	40 x 63
3900	380LX392M200A082	0.055	0.030	6.60	9.25	35 x 80
3900	382LX392M200N062	0.055	0.030	6.80	9.50	40 x 63
3900	382LX392M200B052V	0.055	0.030	8.22	9.45	50 x 50
4700	382LX472M200N082	0.046	0.025	8.38	11.73	40 x 80
4700	382LX472M200B062V	0.046	0.025	9.32	13.05	50 x 63
5600	380LX562M200N102	0.040	0.020	8.90	12.46	40 x 105
6800	382LX682M200N102	0.032	0.017	8.65	12.11	40 x 105
6800	382LX682M200B082V	0.032	0.017	11.41	15.97	50 x 80
7500	382LX752M200B092V	0.029	0.016	12.28	17.19	50 x 92
8200	382LX822M200B102V	0.026	0.014	13.16	18.42	50 x 105
250 Vdc (300 Vdc Surge)						
120	380LX121M250H012	1.660	0.850	0.50	0.60	22 x 25
150	380LX151M250H012	1.330	0.460	1.00	1.25	22 x 25
180	380LX181M250H012	1.110	0.550	1.10	1.50	22 x 25
220	380LX221M250H012	0.900	0.450	1.30	1.70	22 x 25

Type 380LX / 382LX 85 °C High Capacitance, Snap-In Aluminum

2, 4 and 5 pin styles available

Cap. (uF)	Catalog Part Number	Max. ESR		Ripple Amps		Nominal Size D x L (mm)
		@ +25°C		@ +85°C		
		120 Hz (ohms)	20 kHz (ohms)	120 Hz (A)	20 kHz (A)	
250 Vdc (300 Vdc Surge)						
270	380LX271M250H022	0.620	0.250	1.30	1.80	22 x 30
330	380LX331M250H042	0.600	0.300	1.66	2.32	22 x 40
330	380LX331M250J022	0.550	0.220	1.80	2.50	25 x 30
390	380LX391M250J032	0.510	0.260	1.91	2.67	25 x 35
470	380LX471M250J032	0.420	0.190	2.11	2.95	25 x 35
470	380LX471M250J042	0.039	1.550	2.10	3.00	25 x 40
560	380LX561M250J032	0.360	0.160	2.25	3.15	25 x 35
560	380LX561M250K022	0.326	0.130	2.30	3.20	30 x 30
680	380LX681M250J452	0.270	0.110	2.50	3.50	25 x 45
680	380LX681M250K032	0.268	0.107	2.50	3.50	30 x 35
820	380LX821M250K042	0.222	0.089	2.80	3.90	30 x 40
820	380LX821M250A022	0.222	0.089	2.80	3.90	35 x 30
1000	380LX102M250K452	0.182	0.073	3.32	4.65	30 x 45
1000	380LX102M250A032	0.182	0.073	3.32	4.65	35 x 35
1200	380LX122M250A042	0.166	0.083	3.53	4.94	35 x 40
1500	380LX152M250A052	0.133	0.068	4.00	5.70	35 x 50
1500	382LX152M250N042	0.133	0.066	4.04	5.66	40 x 40
1800	380LX182M250A062	0.110	0.055	4.50	6.30	35 x 63
1800	382LX182M250N052	0.110	0.055	4.50	6.30	40 x 50
1800	382L182M250N062	0.062	0.030	4.80	6.40	40 x 63
2200	380LX222M250A062	0.090	0.045	4.70	6.60	35 x 63
2200	380LX222M250A082	0.090	0.045	4.90	6.90	35 x 80
2200	382LX222M250N062	0.090	0.045	4.90	6.90	40 x 63
2700	380LX272M250A082	0.074	0.037	5.60	7.90	35 x 80
2700	382LX272M250N062	0.074	0.037	5.80	8.10	40 x 63
2700	382L272M250N082	0.043	0.021	6.30	8.40	40 x 80
2700	382LX272M250B052V	0.074	0.037	6.77	7.79	50 x 50
3300	382LX332M250N082	0.060	0.030	7.00	9.80	40 x 80
3300	382LX332M250B062V	0.060	0.030	7.79	10.91	50 x 63
3900	382LX392M250N082	0.051	0.026	7.35	10.30	40 x 80
3900	380LX392M250N102	0.060	0.040	7.47	10.46	40 x 105
4700	382LX472M250N102	0.042	0.021	8.88	12.43	40 x 105
4700	382LX472M250B082V	0.042	0.021	9.65	13.51	50 x 80
5600	382LX562M250B092V	0.036	0.018	10.80	15.12	50 x 92
6800	382LX682M250B102V	0.029	0.015	12.16	17.02	50 x 105
315 Vdc (365 Vdc Surge)						
100	380LX101M315H012	1.930	1.020	0.90	1.30	22 x 25
120	380LX121M315H012	1.660	0.860	1.00	1.40	22 x 25
150	380LX151M315H022	1.330	0.600	1.10	1.60	22 x 30
180	380LX181M315H022	1.110	0.550	1.21	1.69	22 x 30
220	380LX221M315H032	0.900	0.450	1.41	1.97	22 x 35
270	380LX271M315J032	0.740	0.370	1.60	2.24	25 x 35

Cap. (uF)	Catalog Part Number	Max. ESR		Ripple Amps		Nominal Size D x L (mm)
		@ +25°C		@ +85°C		
		120 Hz (ohms)	20 kHz (ohms)	120 Hz (A)	20 kHz (A)	
315 Vdc (365 Vdc Surge)						
270	380LX271M315K022	0.737	0.376	1.60	2.20	30 x 30
330	380LX331M315J042	0.600	0.300	1.82	2.55	25 x 40
330	380LX331M315K022	0.603	0.308	1.80	2.50	30 x 30
390	380LX391M315J042	0.510	0.260	2.01	2.81	25 x 40
390	380LX391M315K032	0.510	0.260	2.00	2.80	30 x 35
390	380LX391M315A022	0.510	0.260	2.00	2.80	35 x 30
470	380LX471M315K042	0.423	0.216	2.30	3.20	30 x 40
470	380LX471M315A032	0.423	0.216	2.30	3.20	35 x 35
560	380LX561M315K452	0.355	0.181	2.60	3.60	30 x 45
560	380LX561M315A032	0.355	0.181	2.60	3.60	35 x 35
680	380LX681M315A452	0.293	0.149	2.90	4.00	35 x 45
820	380LX821M315A052	0.243	0.124	3.30	4.60	35 x 50
1000	380L102M315A062	0.218	0.129	2.70	3.60	35 x 63
1200	380L122M315A072	0.182	0.107	3.20	4.20	35 x 70
1200	382L122M315N052	0.202	0.122	2.90	3.90	40 x 50
1500	380L152M315A082	0.153	0.090	3.60	4.80	35 x 80
1500	382L152M315N062	0.162	0.098	3.40	4.50	40 x 63
1800	382L182M315N082	0.113	0.069	4.50	6.00	40 x 80
350 Vdc (400 Vdc Surge)						
82	380LX820M350H012	2.430	1.240	0.83	1.16	22 x 25
100	380LX101M350H022	1.990	1.020	0.70	1.10	22 x 30
120	380LX121M350H022	1.660	0.750	1.00	1.40	22 x 30
150	380LX151M350H022	1.330	0.600	1.10	1.60	22 x 30
180	380LX181M350H022	1.110	0.500	1.20	1.70	22 x 30
220	380LX221M350H042	0.900	0.410	1.44	2.00	22 x 40
270	380LX271M350H452	0.740	0.380	1.66	2.32	22 x 45
270	380LX271M350K022	0.614	0.215	1.66	2.32	30 x 30
330	380LX331M350J042	0.600	0.300	1.88	2.63	25 x 40
330	380LX331M350K032	0.500	0.180	1.90	2.60	30 x 35
330	380LX331M350A022	0.500	0.180	1.90	2.60	35 x 30
390	380LX391M350J452	0.510	0.230	1.80	2.50	25 x 45
390	380LX391M350K042	0.425	0.149	2.06	2.88	30 x 40
390	380LX391M350A022	0.425	0.149	2.06	2.88	35 x 30
470	380LX471M350K052	0.390	0.140	2.40	3.40	30 x 50
470	380LX471M350A032	0.390	0.140	2.40	3.40	35 x 35
560	380LX561M350K052	0.326	0.114	2.60	3.64	30 x 50
560	380LX561M350A042	0.326	0.114	2.60	3.64	35 x 40
680	380LX681M350A452	0.293	0.117	2.96	4.14	35 x 45
680	382LX681M350N042	0.293	0.117	3.00	4.10	40 x 40
820	380LX821M350A052	0.243	0.097	3.55	4.97	35 x 50
1000	380LX102M350A062	0.250	0.110	3.80	5.30	35 x 63
1000	382LX102M350N052	0.250	0.110	3.80	5.30	40 x 50

Type 380LX / 382LX 85 °C High Capacitance, Snap-In Aluminum

2, 4 and 5 pin styles available

Cap. (uF)	Catalog Part Number	Max. ESR		Ripple Amps		Nominal Size D x L (mm)
		@ +25°C		@ +85°C		
		120 Hz (ohms)	20 kHz (ohms)	120 Hz (A)	20 kHz (A)	
350 Vdc (400 Vdc Surge)						
1200	380LX122M350A082	0.210	0.095	4.40	6.20	35 x 80
1200	382LX122M350N062	0.210	0.095	4.40	6.20	40 x 63
1200	382LX122M350B052V	0.207	0.093	5.18	5.96	50 x 50
1500	382LX152M350B062V	0.166	0.075	6.01	8.41	50 x 63
1800	380LX182M350A102	0.140	0.060	5.79	8.11	35 x 105
1800	382LX182M350N082	0.138	0.062	5.85	8.20	40 x 80
1800	382LX182M350B082V	0.138	0.062	6.89	9.65	50 x 80
2200	382LX222M350N102	0.113	0.051	6.91	9.67	40 x 105
2200	382LX222M350B092V	0.113	0.051	7.79	10.91	50 x 92
2700	382LX272M350B102V	0.092	0.041	8.80	12.32	50 x 105
400 Vdc (450 Vdc Surge)						
47	380LX470M400H012	4.500	1.600	0.30	0.42	22 x 25
68	380LX680M400H012	2.930	1.000	0.35	0.50	22 x 25
82	380LX820M400H012	2.440	0.850	0.70	0.95	22 x 25
100	380LX101M400H012	1.990	0.900	0.90	1.30	22 x 25
100	380LX101M400H022	1.650	0.580	0.90	1.30	22 x 30
100	380LX101M400J012	1.650	0.580	0.90	1.30	25 x 25
120	380LX121M400H022	1.660	0.750	1.00	1.40	22 x 30
150	380LX151M400H032	1.330	0.460	1.20	1.60	22 x 35
150	380LX151M400J022	1.100	0.390	1.20	1.60	25 x 30
180	380LX181M400J032	1.100	0.500	1.30	1.85	25 x 35
220	380LX221M400J022	0.900	0.450	1.49	2.09	25 x 30
220	380LX221M400K022	0.750	0.260	1.50	2.10	30 x 30
270	380LX271M400J452	0.680	0.240	1.70	2.30	25 x 45
270	380LX271M400K022	0.740	0.370	1.67	2.34	30 x 30
270	380LX271M400K032	0.680	0.240	1.70	2.30	30 x 35
270	380LX271M400A022	0.680	0.240	1.70	2.30	35 x 30
330	380LX331M400K042	0.550	0.200	1.90	2.70	30 x 40
330	380LX331M400A022	0.550	0.200	1.90	2.70	35 x 30
330	380LX331M400A032	0.502	0.201	1.40	1.90	35 x 35
390	380LX391M400J452	0.470	0.160	2.10	3.00	25 x 45
390	380LX391M400K452	0.470	0.160	2.10	3.00	30 x 45
390	380LX391M400A032	0.470	0.160	2.10	3.00	35 x 35
470	380LX471M400A042	0.388	0.136	2.39	3.35	35 x 40
560	380LX561M400A452	0.326	0.114	2.69	3.77	35 x 45
560	382LX561M400N042	0.326	0.114	2.70	3.80	40 x 40
680	380LX681M400A052	0.270	0.095	3.00	4.20	35 x 50
680	382LX681M400N052	0.270	0.095	3.40	4.70	40 x 50
820	380LX821M400A062	0.222	0.078	3.55	4.97	35 x 63
820	382LX821M400N052	0.222	0.078	3.40	4.70	40 x 50
1000	380L102M400A082	0.179	0.099	3.60	4.80	35 x 80
1000	382LX102M400N062	0.199	0.127	4.20	5.80	40 x 63

Cap. (uF)	Catalog Part Number	Max. ESR		Ripple Amps		Nominal Size D x L (mm)
		@ +25°C		@ +85°C		
		120 Hz (ohms)	20 kHz (ohms)	120 Hz (A)	20 kHz (A)	
400 Vdc (450 Vdc Surge)						
1000	382LX102M400B052V	0.199	0.080	4.76	5.47	50 x 50
1200	380LX122M400A082	0.152	0.053	4.52	6.33	35 x 80
1200	382LX122M400N062	0.152	0.053	4.52	6.33	40 x 63
1200	382LX122M400B062V	0.166	0.066	5.47	7.66	50 x 63
1500	380LX152M400A102	0.120	0.040	5.44	7.62	35 x 105
1500	382LX152M400N082	0.122	0.043	5.50	7.70	40 x 80
1500	382LX152M400B082V	0.133	0.053	6.47	9.06	50 x 80
1800	382LX182M400N102	0.101	0.035	6.53	9.14	40 x 105
1800	382LX182M400B092V	0.111	0.044	7.35	10.29	50 x 92
2200	382LX222M400B102V	0.090	0.036	8.43	11.80	50 x 105
420 Vdc (470 Vdc Surge)						
82	380LX820M420H012	2.430	0.850	0.80	1.15	22 x 25
100	380LX101M420H022	1.820	0.820	0.90	1.30	22 x 30
120	380LX121M420H022	1.660	0.750	0.90	1.30	22 x 30
150	380LX151M420H042	1.330	0.600	1.15	1.60	22 x 40
180	380LX181M420H042	1.110	0.500	1.45	2.00	22 x 40
180	380LX181M420K022	1.100	0.390	1.45	2.00	30 x 30
220	380LX221M420H452	0.900	0.410	1.50	2.10	22 x 45
220	380LX221M420K022	0.900	0.320	1.50	2.10	30 x 30
270	380LX271M420J452	0.740	0.330	1.70	2.30	25 x 45
270	380LX271M420K032	0.740	0.260	1.70	2.30	30 x 35
270	380LX271M420A022	0.740	0.260	1.70	1.93	35 x 30
330	380LX331M420K452	0.600	0.210	1.90	2.68	30 x 45
330	380LX331M420A032	0.600	0.210	1.90	2.68	35 x 35
390	380LX391M420K052	0.500	0.180	2.10	3.00	30 x 50
390	380LX391M420A042	0.500	0.180	2.10	3.00	35 x 40
470	380LX471M420A452	0.420	0.150	2.40	3.35	35 x 45
560	380LX561M420A052	0.355	0.125	2.70	3.80	35 x 50
450 Vdc (500 Vdc Surge)						
33	380LX330M450H012	6.030	2.400	0.40	0.57	22 x 25
47	380LX470M450H202	4.230	1.690	0.30	0.40	22 x 20
56	380LX560M450H012	3.550	1.600	0.70	1.00	22 x 25
68	380LX680M450H012	2.930	1.020	0.80	1.10	22 x 25
82	380LX820M450H012	2.000	0.810	0.80	1.20	22 x 25
82	380LX820M450H022	2.430	1.210	0.83	1.16	22 x 30
100	380LX101M450H022	1.990	0.790	0.90	1.30	22 x 30
120	380LX121M450H022	1.659	0.661	1.00	1.50	22 x 30
120	380LX121M450H032	1.660	0.750	0.90	1.35	22 x 35
120	380LX121M450J012	1.380	0.550	1.00	1.50	25 x 25
150	380LX151M450H032	1.330	0.590	1.18	1.66	22 x 35
150	380LX151M450K022	1.100	0.440	1.20	1.70	30 x 30
180	380LX181M450J032	1.110	0.380	1.20	1.75	25 x 35

Type 380LX / 382LX 85 °C High Capacitance, Snap-In Aluminum

2, 4 and 5 pin styles available

Cap. (uF)	Catalog Part Number	Max. ESR		Ripple Amps		Nominal Size D x L (mm)
		@ +25°C		@ +85°C		
		120 Hz (ohms)	20 kHz (ohms)	120 Hz (A)	20 kHz (A)	
450 Vdc (500 Vdc Surge)						
180	380LX181M450K012	0.921	0.368	1.40	1.90	30 x 25
180	380LX181M450K022	0.921	0.368	1.35	1.89	30 x 30
220	380LX221M450H452	0.754	0.301	1.40	2.00	22 x 45
220	380LX221M450J452	0.750	0.300	1.40	2.00	25 x 45
220	380LX221M450J052	0.754	0.301	1.55	2.17	25 x 50
220	380LX221M450K032	0.754	0.301	1.55	2.17	30 x 35
220	380LX221M450A022	0.904	0.461	1.60	2.20	35 x 30
270	380LX271M450K452	0.680	0.270	1.80	2.50	30 x 45
270	380LX271M450A022	0.680	0.270	1.80	2.50	35 x 30
330	380LX331M450K052	0.550	0.250	2.00	2.80	30 x 50
330	380LX331M450A032	0.553	0.221	2.01	2.81	35 x 35
390	380LX391M450A452	0.510	0.260	2.20	3.10	35 x 45
470	380LX471M450A452	0.423	0.233	2.53	3.54	35 x 45
470	382LX471M450N042	0.423	0.233	2.53	3.54	40 x 40
560	380LX561M450A052	0.355	0.171	2.50	3.50	35 x 50
560	380LX561M450A062	0.355	0.195	2.90	4.10	35 x 63
680	380L681M450A072	0.226	0.120	3.20	4.20	35 x 70
680	382LX681M450N052	0.290	0.160	3.15	4.40	40 x 50
680	382L681M450N062	0.201	0.109	3.40	4.50	40 x 63
820	380LX821M450A082	0.243	0.133	3.80	5.30	35 x 80
820	382LX821M450N062	0.243	0.133	3.70	5.20	40 x 63
820	382LX821M450B052V	0.263	0.145	4.31	4.96	50 x 50
1000	382LX102M450N082	0.216	0.119	4.20	5.90	40 x 80
1000	382LX102M450B062V	0.216	0.119	4.96	6.94	50 x 63
1200	380LX122M450A102	0.170	0.090	4.80	6.72	35 x 105
1200	382LX122M450N082	0.166	0.091	4.85	6.80	40 x 80
1200	382LX122M450B082V	0.180	0.099	5.71	7.99	50 x 80
1500	382LX152M450N102	0.133	0.073	5.81	8.13	40 x 105
1500	382LX152M450B092V	0.144	0.079	6.55	9.17	50 x 92
1800	382LX182M450B102V	0.120	0.066	7.38	10.30	50 x 105
500 Vdc (550 Vdc Surge)						
33	380LX330M500H012	4.420	2.652	0.60	0.80	22 x 25
47	380LX470M500H012	3.500	2.100	0.63	0.88	22 x 25
56	380LX560M500H022	2.980	1.788	0.70	0.98	22 x 30
68	380LX680M500H032	2.720	1.632	0.78	1.09	22 x 35
68	380LX680M500J012	2.720	1.632	0.78	1.09	25 x 25
82	380LX820M500H042	2.455	1.473	0.88	1.23	22 x 40
82	380LX820M500J022	2.455	1.473	0.88	1.23	25 x 30
82	380LX820M500K012	2.455	1.473	0.90	1.20	30 x 25
100	380LX101M500H452	2.013	1.208	0.99	1.39	22 x 45
100	380LX101M500J032	2.013	1.208	0.99	1.39	25 x 35
100	380LX101M500J042	2.013	1.208	1.10	1.50	25 x 40

Cap. (uF)	Catalog Part Number	Max. ESR		Ripple Amps		Nominal Size D x L (mm)
		@ +25°C		@ +85°C		
		120 Hz (ohms)	20 kHz (ohms)	120 Hz (A)	20 kHz (A)	
500 Vdc (550 Vdc Surge)						
100	380LX101M500K022	2.013	1.208	1.10	1.50	30 x 30
100	380LX101M500A012	2.013	1.208	1.10	1.50	35 x 25
120	380LX121M500H052	1.678	1.007	1.13	1.58	22 x 50
120	380LX121M500J042	1.678	1.007	1.13	1.58	25 x 40
120	380LX121M500K022	1.678	1.007	1.13	1.58	30 x 30
120	380LX121M500K032	1.678	1.007	1.40	1.90	30 x 35
120	380LX121M500A022	1.678	1.007	1.40	1.90	35 x 30
150	380LX151M500J452	1.105	0.442	1.29	1.80	25 x 45
150	380LX151M500J052	0.945	0.585	1.40	1.90	25 x 50
150	380LX151M500K032	1.105	0.442	1.29	1.80	30 x 35
150	380LX151M500K042	0.926	0.562	1.60	2.20	30 x 40
150	380LX151M500A012	1.342	0.805	1.29	1.80	35 x 25
180	380LX181M500J052	0.920	0.368	1.38	1.93	25 x 50
180	380LX181M500K042	0.920	0.368	1.38	1.93	30 x 40
180	380LX181M500A022	1.119	0.617	1.38	1.93	35 x 30
180	380LX181M500A032	1.119	0.617	1.60	2.20	35 x 35
220	380LX221M500K452	0.754	0.339	1.50	2.10	30 x 45
220	380LX221M500K052	0.654	0.397	2.00	2.70	30 x 50
220	380LX221M500A032	0.915	0.549	1.50	2.10	35 x 35
220	380LX221M500A042	0.915	0.549	1.90	2.50	35 x 40
270	380LX271M500A042	0.746	0.447	1.76	2.46	35 x 40
270	380LX271M500A052	0.746	0.447	2.30	3.10	35 x 50
270	382L271M500N042	0.746	0.447	2.40	3.20	40 x 40
330	380LX331M500A452	0.610	0.366	1.99	2.79	35 x 45
330	382LX331M500N042	0.610	0.366	2.16	3.00	40 x 40
390	380LX391M500A052	0.516	0.310	2.22	3.11	35 x 50
390	380LX391M500A062	0.516	0.310	2.70	3.60	35 x 63
390	382L391M500N052	0.516	0.310	2.90	3.90	40 x 50
470	380LX471M500A062	0.428	0.257	2.58	3.61	35 x 63
470	380LX471M500A072	0.428	0.257	3.20	4.20	35 x 70
470	382LX471M500N052	0.428	0.257	2.70	3.78	40 x 50
470	382L471M500N062	0.428	0.257	3.40	4.50	40 x 63
560	380LX561M500A082	0.360	0.216	3.60	4.80	35 x 80
560	382LX561M500N062	0.360	0.216	3.11	4.35	40 x 63
560	382LX561M500B052V	0.360	0.216	3.52	4.05	50 x 50
680	380LX681M500A082	0.296	0.178	3.21	4.49	35 x 80
680	382L681M500N082	0.296	0.178	4.50	6.00	40 x 80
680	382LX681M500B062V	0.296	0.178	4.07	5.70	50 x 63
820	380LX821M500A102	0.246	0.147	3.97	5.56	35 x 105
820	382LX821M500N082	0.246	0.147	3.88	5.43	40 x 80
1000	382LX102M500B082V	0.199	0.121	5.05	7.07	50 x 80
1200	382LX122M500N102	0.168	0.101	5.90	8.26	40 x 105
1200	382LX122M500B092V	0.168	0.101	5.74	8.04	50 x 92
1500	382LX152M500B102V	0.134	0.081	6.65	9.31	50 x 105

Notice and Disclaimer: All product drawings, descriptions, specifications, statements, information and data (collectively, the “Information”) in this datasheet or other publication are subject to change. The customer is responsible for checking, confirming and verifying the extent to which the Information contained in this datasheet or other publication is applicable to an order at the time the order is placed. All Information given herein is believed to be accurate and reliable, but it is presented without any guarantee, warranty, representation or responsibility of any kind, expressed or implied. Statements of suitability for certain applications are based on the knowledge that the Cornell Dubilier company providing such statements (“Cornell Dubilier”) has of operating conditions that such Cornell Dubilier company regards as typical for such applications, but are not intended to constitute any guarantee, warranty or representation regarding any such matter - and Cornell Dubilier specifically and expressly disclaims any guarantee, warranty or representation concerning the suitability for a specific customer application, use, storage, transportation, or operating environment. The Information is intended for use only by customers who have the requisite experience and capability to determine the correct products for their application. Any technical advice inferred from this Information or otherwise provided by Cornell Dubilier with reference to the use of any Cornell Dubilier products is given gratis (unless otherwise specified by Cornell Dubilier), and Cornell Dubilier assumes no obligation or liability for the advice given or results obtained. Although Cornell Dubilier strives to apply the most stringent quality and safety standards regarding the design and manufacturing of its products, in light of the current state of the art, isolated component failures may still occur. Accordingly, customer applications which require a high degree of reliability or safety should employ suitable designs or other safeguards (such as installation of protective circuitry or redundancies or other appropriate protective measures) in order to ensure that the failure of an electrical component does not result in a risk of personal injury or property damage. Although all product-related warnings, cautions and notes must be observed, the customer should not assume that all safety measures are indicated in such warnings, cautions and notes, or that other safety measures may not be required.