

X2Y[®]



Technology In Balance

JOHANSON
DIELECTRICS 

X2Y® FILTER & DECOUPLING CAPACITORS

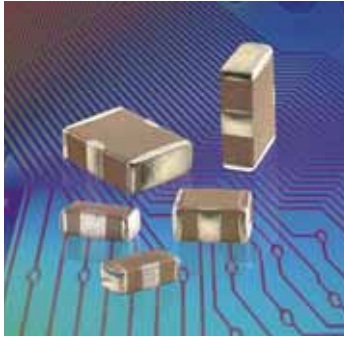

X2Y® filter capacitors employ a unique, patented low inductance design featuring two balanced capacitors that are immune to temperature, voltage and aging performance differences.

These components offer superior decoupling and EMI filtering performance, virtually eliminate parasitics, and can replace multiple capacitors and inductors saving board space and reducing assembly costs.

ADVANTAGES

- One device for EMI suppression or decoupling
- Replace up to 7 components with one X2Y
- Differential and common mode attenuation
- Matched capacitance line to ground, both lines
- Low inductance due to cancellation effect

APPLICATIONS

- FPGA / ASIC / μ -P Decoupling
- DDR Memory Decoupling
- Amplifier Filter & Decoupling
- High Speed Data Filtering
- Cellular Handsets

Circuit 1 (1 Y-Cap.)		<10pF	10pF	22pF	27pF	33pF	47pF	100pF	220pF	470pF	1000pF	1500pF	2200pF	4700pF	.010 μ F	.015 μ F	.022 μ F	.039 μ F	.047 μ F	0.10 μ F	0.18 μ F	0.22 μ F	0.33 μ F	0.40 μ F	0.47 μ F	1.0 μ F	
Circuit 2 (2 Y-Caps.)		<20pF	20pF	44pF	54pF	66pF	94pF	200pF	440pF	940pF	2000pF	3000pF	4400pF	9400pF	.020 μ F	.030 μ F	.044 μ F	.078 μ F	.094 μ F	0.20 μ F	0.36 μ F	0.44 μ F	0.68 μ F	0.80 μ F	0.94 μ F	2.0 μ F	
SIZE	CAP. CODE	XR	100	220	270	330	470	101	221	471	102	152	222	472	103	153	223	393	473	104	184	224	334	404	474	105	
0402 (X07)	NPO	50	50	50	50	50	50	50																			
	X7R								50	50	50	50	50	50	16												
0603 (X14)	NPO	100	100	100	100	100	50	50	50																		
	X7R							100	100	100	100	100	100	100	50	25	25		16	10		6.3					
	X5R																					16	10		10	10	
0805 (X15)	NPO		100	100	100	100	100	100	100	50																	
	X7R							100	100	100	100	100	100	100	100	50	50		50	25	10						
1206 (X18)	NPO										100																
	X7R														100	100	100		100	100		16	16		10		
1210 (X41)	X7R														500					100		100	100		25	16	
1410 (X44)	X7R															500								100			
1812 (X43)	X7R																	500							100		

SEE PART NUMBER LISTING TABLE ON PAGES 7 & 8 Contact factory for part combinations not shown.
 Circuit 1 capacitance measured Line-to-Ground (A or B to G) Circuit 2 capacitance measured Power-to-Ground (A + B to G)
 Rated voltage is from line to ground in Circuit 1, power to ground in Circuit 2.

HOW TO ORDER X2Y® FILTER & DECOUPLING CAPACITORS

P/N written: 100X14W104MV4T

100	X14	W	104	M	V	4	T
VOLTAGE 6R3 = 6.3 V 100 = 10 V 160 = 16 V 250 = 25 V 500 = 50 V 101 = 100 V 501 = 100 V	CASE SIZE X07 = 0402 X14 = 0603 X15 = 0805 X18 = 1206 X41 = 1210 X43 = 1812 X44 = 1410	DIELECTRIC N = NPO W = X7R X = X5R	CAPACITANCE (Circuit 1) 1st two digits are significant; third digit denotes number of zeros. 102 = 1000 pF = 1 nF 103 = 0.01 μ F = 10 nF 104 = 0.10 μ F = 100 nF	TOLERANCE M = \pm 20%	TERMINATION V = Ni barrier w/ 100% Sn Plating Available on select parts: F = Polyterm® soft polymer termination T = SnPb		TAPE MODIFIER Code Tape Reel E Embossed 7" T Paper 7" Tape specs. per EIA RS481
				MARKING 4 = Unmarked			

X2Y® technology patents and registered trademark under license from X2Y ATTENUATORS, LLC



www.johansondielectrics.com

X2Y® FILTER & DECOUPLING CAPACITORS

Filtering Circuit 1 S21 Signal-to-Ground

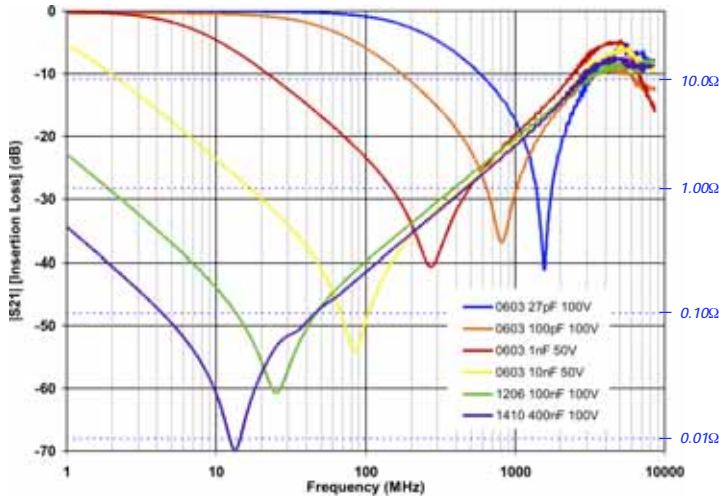
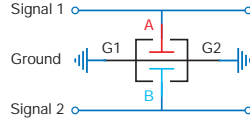

Decoupling Circuit 2 S21 Power-to-Ground

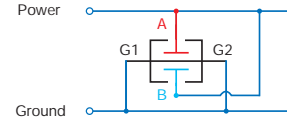

Labeled capacitance values below follow the P/N order code or Y cap value (Circuit 1).
Effective capacitance measured in Circuit 2 is 200% of the labeled Circuit 1 Y cap value.

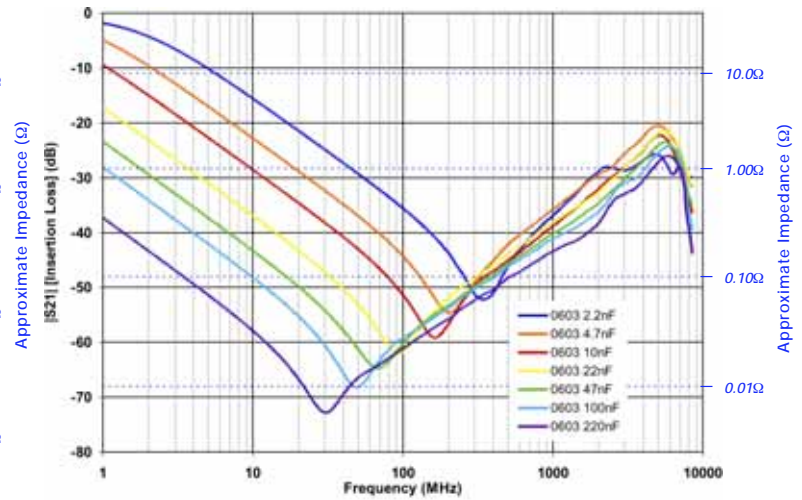

ELECTRICAL CHARACTERISTICS

	NPO	X7R	X5R
Temperature Coefficient:	0±30ppm/°C (-55 to +125°C)	±15% (-55 to +125°C)	±15% (-55 to +85°C)
Dielectric Strength:	WVDC ≤ 100V: 2.5 X WVDC, 25°C, 50mA max. WVDC = 500V: 1.4 X WVDC, 25°C, 50mA max.		
Dissipation Factor:	0.1% max.	WVDC ≥ 50 VDC: 2.5% max. WVDC = 25 VDC: 3.5% max. WVDC = 10-16 VDC: 5.0% max. WVDC = 6.3 VDC: 10% max.	WVDC ≥ 50 VDC: 5% max. WVDC ≤ 25 VDC: 10% max.
Insulation Resistance (Min. @ 25°C, WVDC)	C ≤ 0.047μF: 1000 ΩF or 100 GΩ, whichever is less C > 0.047μF: 500 ΩF or 10 GΩ, whichever is less		
Test Conditions:	C > 100 pF: 1kHz ±50Hz; 1.0±0.2 VRMS C ≤ 100 pF: 1Mhz ±50kHz; 1.0±0.2 VRMS	1.0kHz±50Hz @ 1.0±0.2 Vrms	
Other:	See main catalog page 18 for additional dielectric specifications.		

Equivalent Circuits

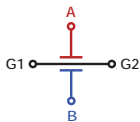

Cross-sectional View

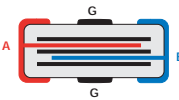

Dimensional View

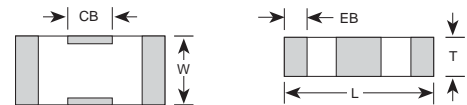

MECHANICAL CHARACTERISTICS

	0402 (X07)		0603 (X14)		0805 (X15)		1206 (X18)		1210 (X41)		1410 (X44)		1812 (X43)	
	IN	mm	IN	mm	IN	mm	IN	mm	IN	mm	IN	mm	IN	mm
L	0.045 ± 0.003	1.143 ± 0.076	0.064 ± 0.005	1.626 ± 0.127	0.080 ± 0.008	2.032 ± 0.203	0.124 ± 0.010	3.150 ± 0.254	0.125 ± 0.010	3.175 ± 0.254	0.140 ± 0.010	3.556 ± 0.254	0.174 ± 0.010	4.420 ± 0.254
W	0.024 ± 0.003	0.610 ± 0.076	0.035 ± 0.005	0.889 ± 0.127	0.050 ± 0.008	1.270 ± 0.203	0.063 ± 0.010	1.600 ± 0.254	0.098 ± 0.010	2.489 ± 0.254	0.098 ± 0.010	2.490 ± 0.254	0.125 ± 0.010	3.175 ± 0.254
T	0.020 max	0.508 max	0.026 max	0.660 max	0.040 max	1.016 max	0.050 max	1.270 max	0.070 max	1.778 max	0.070 max	1.778 max	0.090 max	2.286 max
EB	0.008 ± 0.003	0.203 ± 0.076	0.010 ± 0.006	0.254 ± 0.152	0.012 ± 0.008	0.305 ± 0.203	0.016 ± 0.010	0.406 ± 0.254	0.018 ± 0.010	0.457 ± 0.254	0.018 ± 0.010	0.457 ± 0.254	0.022 ± 0.012	0.559 ± 0.305
CB	0.010 ± 0.003	0.305 ± 0.076	0.018 ± 0.004	0.457 ± 0.102	0.022 ± 0.005	0.559 ± 0.127	0.040 ± 0.005	1.016 ± 0.127	0.045 ± 0.005	1.143 ± 0.127	0.045 ± 0.005	1.143 ± 0.127	0.045 ± 0.005	1.143 ± 0.127



www.johansondielectrics.com

X2Y® FILTER & DECOUPLING CAPACITORS

The X2Y® Design - A Balanced, Low ESL, "Capacitor Circuit"

The X2Y® capacitor design starts with standard 2 terminal MLC capacitor's opposing electrode sets, A & B, and adds a third electrode set (G) which surround each A & B electrode. The result is a highly versatile three node capacitive circuit containing two tightly matched, low inductance capacitors in a compact, four-terminal SMT chip.

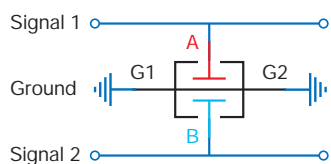
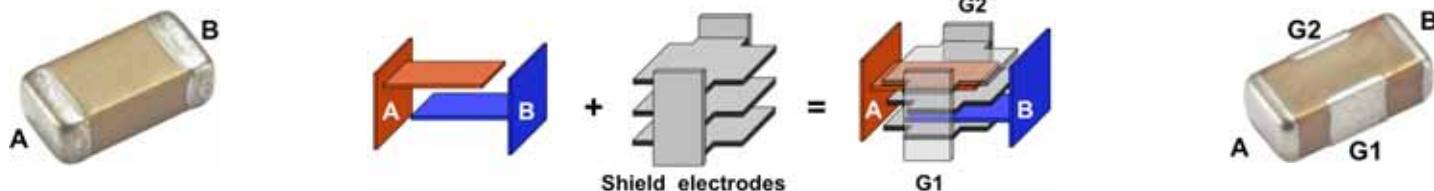

X2Y® Circuit 1: Filtering

Circuit 1 connects the X2Y® filter capacitor across two signal lines. Common-mode noise is filtered to ground (or reference) by the two Y-capacitors, A & B. Because X2Y® is a balanced circuit that is tightly matched in both phase and magnitude with respect to ground, common-to-differential mode noise conversion is minimized and any differential-mode noise is cancelled within the device. The low inductance of the capacitors extends their high frequency attenuation considerably over discrete MLCs.

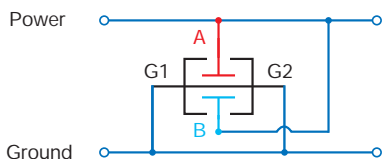

X2Y® Circuit 2: Power Bypass / Decoupling

Circuit 2 connects the A & B capacitors in parallel doubling the total capacitance while reducing the inductance. X2Y capacitors exhibit up to 1/10th the device inductance and 1/5th the mounted inductance of similar sized MLC capacitors enabling high-performance bypass networks with far fewer components and vias. Low ESL delivers improved High Frequency performance into the GHz range.

GSM RFI Attenuation in Audio & Analog

GSM handsets transmit in the 850 and 1850 MHz bands using a TDMA pulse rate of 217Hz. These signals cause the GSM buzz heard in a wide range of audio products from headphones to concert hall PA systems or "silent" signal errors created in medical, industrial process control, and security applications. Testing was conducted where an 840MHz GSM handset signal was delivered to the inputs of three different amplifier test circuit configurations shown below whose outputs were measured on a HF spectrum analyzer.

- 1) No input filter, 2 discrete MLC 100nF power bypass caps.
 - 2) 2 discrete MLC 1nF input filter, 2 discrete MLC 100nF power bypass caps.
 - 3) A single X2Y 1nF input filter, a single X2Y 100nF power bypass cap.
- X2Y configuration provided a nearly flat response above the ambient and up to 10 dB improved rejection than the conventional MLCC configuration.

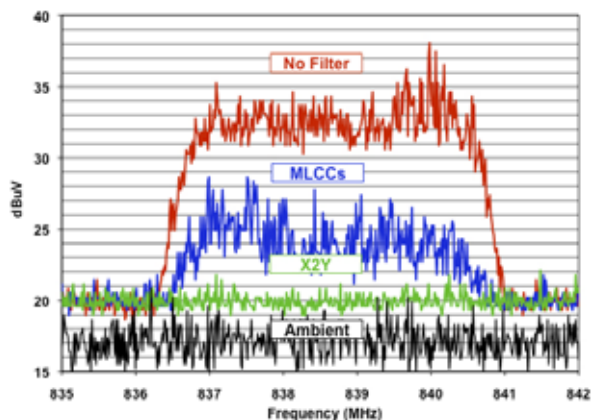

Amplifier Input Filter Example

In this example, a single Johanson X2Y® component was used to filter noise at the input of a DC instrumentation amplifier. This reduced component count by 3-to-1 and costs by over 70% vs. conventional filter components that included 1% film Y-capacitors.

Parameter	X2Y® 10nF	Discrete 10nF, 2 @ 220 pF	Comments
DC offset shift	< 0.1 μ V	< 0.1 μ V	Referred to input
Common mode rejection	91 dB	92 dB	

Source: Analog Devices, "A Designer's Guide to Instrumentation Amplifiers (2nd Edition)" by Charles Kitchin and Lew Counts

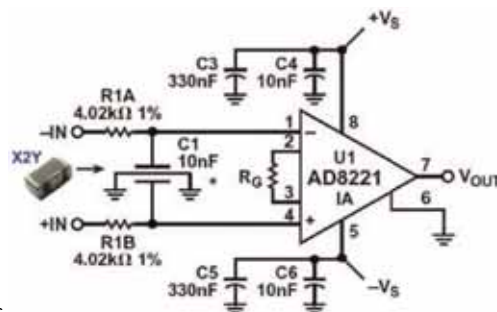

www.johansondielectrics.com

X2Y® FILTER & DECOUPLING CAPACITORS

Common Mode Choke Replacement

In this example, a 5 μH common mode choke is replaced by an 0805, 1000pF X2Y® component achieving superior EMI filtering by a component a fraction of the size and cost.

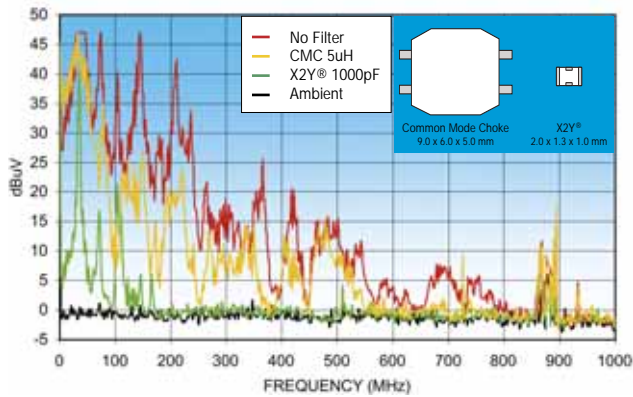

DC Motor EMI Reduction: A Superior Solution

One X2Y® component has successfully replaced 7 discrete filter components while achieving superior EMI filtering.

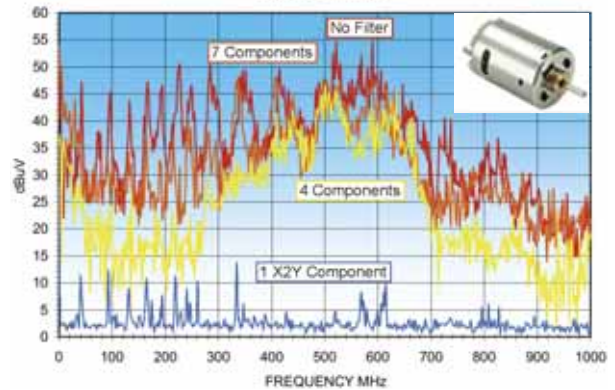

Eliminating Capacitor Anti-Resonance Issue

A common design practice is to parallel decade capacitance values to extend the high frequency performance of the filter network. This causes an unintended and often over-looked effect of anti-resonant peaks in the filter networks combined impedance. X2Y's very low mounted inductance allows designers to use a single, higher value part and completely avoid the anti-resonance problem. The impedance graph on right shows the combined impedance of a 1nF, 10nF & 100nF 0402 MLC in parallel in RED. The MLC networks anti-resonance peaks are nearly 10 times the desired impedance. A 100nF and 47nF X2Y are plotted in BLUE and GREEN. (The total capacitance of X2Y (Circuit 2) is twice the value, or 200nF and 98nF in this example.) The single X2Y is clearly superior to the three paralleled MLCs.

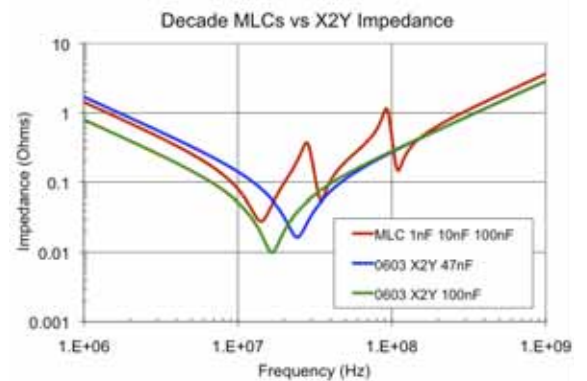

X2Y High Performance Power Bypass - Improve Performance, Reduce Space & Vias

Actual measured performance of two high performance SerDes FPGA designs demonstrate how a 13 component X2Y bypass network significantly outperforms a 38 component MLC network. For more information see http://johanson-dielectrics.com/pdfs/JDI_X2Y_STXII.pdf

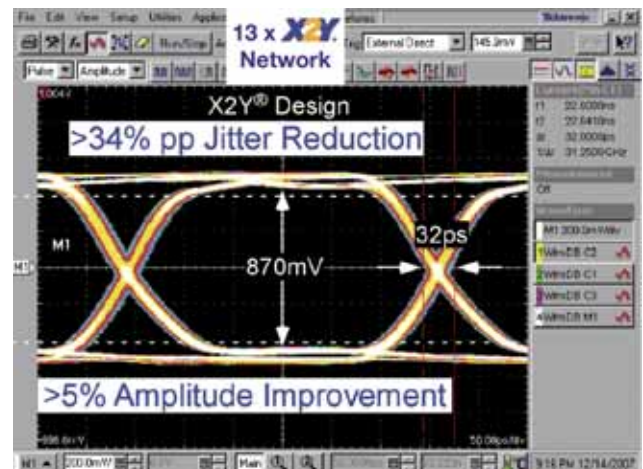
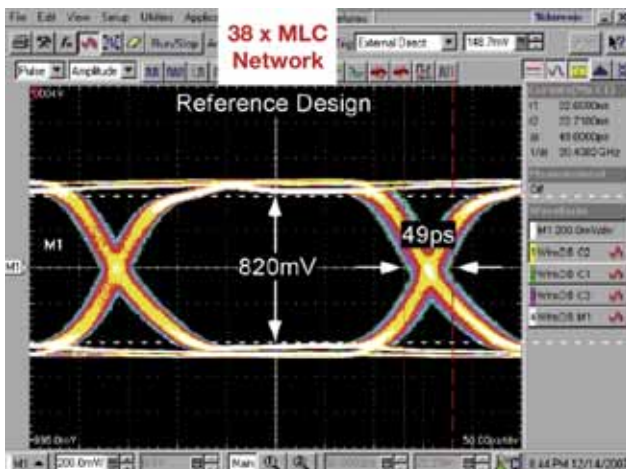

www.johanson-dielectrics.com

X2Y® FILTER & DECOUPLING CAPACITORS

SOLDER PAD RECOMMENDATIONS

	0402 (X07)		0603 (X14)		0805 (X15)		1206 (X18)		1210 (X41)		1410 (X44)		1812 (X43)	
	IN	mm	IN	mm	IN	mm	IN	mm	IN	mm	IN	mm	IN	mm
X	0.020	0.51	0.035	0.89	0.050	1.27	0.065	1.65	0.100	2.54	0.100	2.54	0.125	3.18
Y	0.020	0.51	0.025	0.64	0.035	0.89	0.040	1.02	0.040	1.02	0.040	1.02	0.040	1.02
G	0.024	0.61	0.040	1.02	0.050	1.27	0.080	2.03	0.080	2.03	0.100	2.54	0.130	3.30
V	0.015	0.38	0.020	0.51	0.022	0.56	0.040	1.02	0.045	1.14	0.045	1.14	0.045	1.14
U	0.039	0.99	0.060	1.52	0.080	2.03	0.120	3.05	0.160	4.06	0.160	4.06	0.190	4.83
Z	0.064	1.63	0.090	2.29	0.120	3.05	0.160	4.06	0.160	4.06	0.180	4.57	0.210	5.33

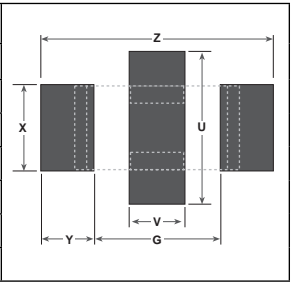

Use of solder mask beneath component is not recommended because of flux/contaminant entrapment.

OPTIMIZING X2Y PERFORMANCE ON THE PCB

X2Y capacitors deliver excellent performance in EMI/RFI filtering and Power Bypass applications. Physical and electrical placement on the PCB is critical in achieving good results. A low inductance, dual ground connection is mandatory.

EMI Filter Applications Low inductance PCB routing examples are shown in figures 1 and 2. Figures 3-5 show unbalanced and high inductance connections and should be avoided. See detailed application note [X2Y EMI Filter Evaluation and PCB Design Guidelines](#).

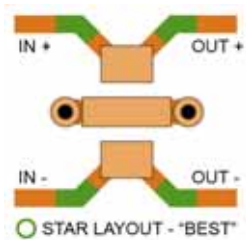

Fig. 1

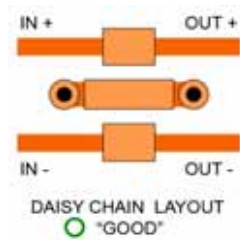

Fig. 2

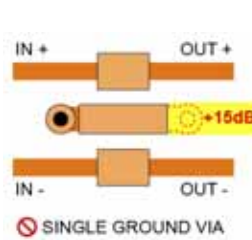

Fig. 3

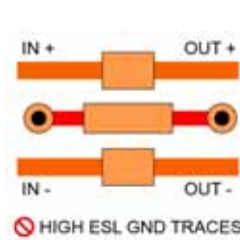

Fig. 4

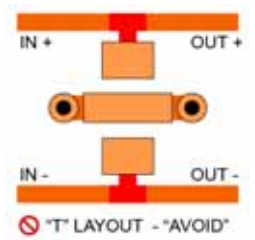
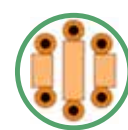
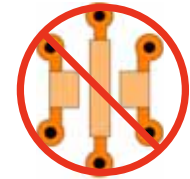

Fig. 5

PDN / Power Bypass Applications Figures on right compare the X2Y recommended layout against a poor layout. Because of its long extents from device terminals to vias, and the wide via separation, the poor layout exhibits approximately 200% L1 inductance, and 150% L2 inductance compared to recommended X2Y layouts. See detailed application note [X2Y Power Bypass Mounting](#).



Recommended X2Y Bypass Layout



LAB EVALUATION SOLDERING PRECAUTIONS

Ceramic capacitors (X2Y and standard MLC types) can be easily damaged when hand soldered. Thermal cracking of the ceramic body is often invisible even under a microscope. Factors that increase thermal cracking risk:

1. 4 terminals to solder can increase hand-soldering time and temperature exposure
2. Pb-free solders have higher reflow temperatures
3. Low inductance connections to ground are inherently good heat-sinks

A damaged component may exhibit a short circuit immediately and not recover, or may operate with intermittent Insulation Resistance (IR) levels. If you are not achieving expected results and have followed the other guidelines carefully, check to see you are adhering to the soldering guidelines below:

- Always pre-heat the PCB and component to within 50°C of solder reflow temperature at 2°C/sec. maximum.
- Use contact-less hand solder tools such as a hot air pencil, IR lamp, etc.
- Avoid over-heating of the ceramic component, temperature limit: 260°C for 20-30 seconds max.
- Use a soldering iron as last resort; 20W max. tip, NO CONTACT with ceramic, limit solder time to 5 seconds max.

A reliable, cost effective prototype PCB reflow soldering process is possible using a household toaster oven. There are several good procedures available on-line by googling "Toaster Oven Soldering"



www.johansondielectrics.com

X2Y® FILTER & DECOUPLING CAPACITORS

SIZE	TC	Y-CAPACITOR		VOLTAGE RATING (DC)	JOHANSON P/N	REEL QTY
		VALUE	TOLERANCE			
0402	NPO/COG	1.8pF	±0.5pF	50	500X07N1R8CV4T	4,000
		2.2pF	±0.5pF	50	500X07N2R2CV4T	4,000
		4.7pF	±0.5pF	50	500X07N4R7CV4T	4,000
		5.6pF	±0.5pF	50	500X07N5R6CV4T	4,000
		10pF	±20%	50	500X07N100MV4T	4,000
		22pF	±20%	50	500X07N220MV4T	4,000
		27pF	±20%	50	500X07N270MV4T	4,000
		33pF	±20%	50	500X07N330MV4T	4,000
		47pF	±20%	50	500X07N470MV4T	4,000
	100pF	±20%	50	500X07N101MV4T	4,000	
	X7R	100pF	±20%	50	500X07W101MV4T	4,000
		220pF	±20%	50	500X07W221MV4T	4,000
		470pF	±20%	50	500X07W471MV4T	4,000
		1.0nF	±20%	50	500X07W102MV4T	4,000
		1.5nF	±20%	50	500X07W152MV4T	4,000
		2.2nF	±20%	50	500X07W222MV4T	4,000
4.7nF		±20%	50	500X07W472MV4T	4,000	
10nF		±20%	16	160X07W103MV4T	4,000	
0603	NPO/COG	1.8pF	±20%	100	101X14N1R8CV4T	4,000
		2.2pF	±20%	100	101X14N2R0CV4T	4,000
		4.7pF	±20%	100	101X14N4R7CV4T	4,000
		5.6pF	±20%	100	101X14N5R6CV4T	4,000
		10pF	±20%	100	101X14N100MV4T	4,000
		22pF	±20%	100	101X14N220MV4T	4,000
		27pF	±20%	100	101X14N270MV4T	4,000
		33pF	±20%	100	101X14N330MV4T	4,000
		47pF	±20%	100	101X14N470MV4T	4,000
		100pF	±20%	50	500X14N101MV4T	4,000
		220pF	±20%	50	500X14N221MV4T	4,000
		X5R	100pF	±20%	100	101X14W101MV4T
	220pF		±20%	100	101X14W221MV4T	4,000
	470pF		±20%	100	101X14W471MV4T	4,000
	1.0nF		±20%	100	101X14W102MV4T	4,000
	1.5nF		±20%	100	101X14W152MV4T	4,000
	2.2nF		±20%	100	101X14W222MV4T	4,000
	4.7nF		±20%	100	101X14W472MV4T	4,000
	10nF		±20%	50	500X14W103MV4T	4,000
	15nF		±20%	25	250X14W153MV4T	4,000
	22nF		±20%	25	250X14W223MV4T	4,000
	47nF		±20%	16	160X14W473MV4T	4,000
	100nF		±20%	10	100X14W104MV4T	4,000
	220nF		±20%	6.3	6R3X14W224MV4T	4,000
	220nF		±20%	16	160X14X224MV4T	4,000
	330nF	±20%	10	100X14X334MV4T	4,000	
470nF	±20%	10	100X14X224MV4T	4,000		
1.0µF	±20%	10	100X14X105MV4T	4,000		

Parts listed in the table are standard parts and carry the highest DC voltage rating for their size and value. Legacy part number requirements for lower voltage codes are fulfilled with the higher voltage rating which exceeds the requirement. Please contact the factory for part values or voltage combinations that are not shown.



X2Y® FILTER & DECOUPLING CAPACITORS

SIZE	TC	Y-CAPACITOR		VOLTAGE RATING (DC)	JOHANSON P/N	REEL QTY
		VALUE	TOLERANCE			
0805	NPO/COG	10pF	±20%	100	101X15N100MV4E	4,000
		22pF	±20%	100	101X15N220MV4E	4,000
		27pF	±20%	100	101X15N270MV4E	4,000
		33pF	±20%	100	101X15N330MV4E	4,000
		47pF	±20%	100	101X15N470MV4E	4,000
		100pF	±20%	100	101X15N101MV4E	4,000
		220pF	±20%	50	500X15N221MV4E	4,000
		470pF	±20%	50	500X15N471MV4E	4,000
	X7R	47pF	±20%	100	101X15W470MV4E	4,000
		100pF	±20%	100	101X15W101MV4E	4,000
		220pF	±20%	100	101X15W221MV4E	4,000
		470pF	±20%	100	101X15W471MV4E	4,000
		1nF	±20%	100	101X15W102MV4E	4,000
		1.5nF	±20%	100	101X15W152MV4E	4,000
		2.2nF	±20%	100	101X15W222MV4E	4,000
		4.7nF	±20%	100	101X15W472MV4E	4,000
		10nF	±20%	100	101X15W103MV4E	4,000
		15nF	±20%	50	500X15W153MV4E	4,000
		22nF	±20%	50	500X15W223MV4E	4,000
		47nF	±20%	50	500X15W473MV4E	4,000
100nF	±20%	25	250X15W104MV4E	4,000		
180nF	±20%	10	100X15W184MV4E	4,000		
1206	NPO/COG	1nF	±20%	100	101X18N102MV4E	3,000
	X7R	10nF	±20%	100	101X18W103MV4E	3,000
		15nF	±20%	100	101X18W153MV4E	3,000
		22nF	±20%	100	101X18W223MV4E	3,000
		47nF	±20%	100	101X18W473MV4E	3,000
		100nF	±20%	100	101X18W104MV4E	3,000
		220nF	±20%	16	160X18W224MV4E	3,000
		330nF	±20%	16	160X18W334MV4E	3,000
470nF	±20%	10	100X18W474MV4E	3,000		
1210	X7R	10nF	±20%	500	501X41W103MV4E	2,000
		100nF	±20%	100	101X41W104MV4E	2,000
		220nF	±20%	100	101X41W224MV4E	2,000
		330nF	±20%	100	101X41W334MV4E	2,000
		1000nF	±20%	16	160X41W105MV4E	2,000
1410	X7R	15nF	±20%	500	501X44W153MV4E	2,000
		400nF	±20%	100	101X44W404MV4E	2,000
1812	X7R	39nF	±20%	500	501X43W393MV4E	1,000
		470nF	±20%	100	101X43W474MV4E	1,000

Parts listed in the table are standard parts and carry the highest DC voltage rating for their size and value.

Legacy part number requirements for lower voltage codes are fulfilled with the higher voltage rating which exceeds the requirement.

Please contact the factory for part values or voltage combinations that are not shown.

Johanson Dielectrics, Inc. reserves the right to make design and price changes without notice. All sales are subject to the terms and conditions printed on the back side of our sales order acknowledgment forms, including a limited warranty and remedies for non-conforming goods or defective goods. We will be pleased to provide a copy of these terms and conditions for your review.

JOHANSON HONG KONG LTD.



JOHANSON EUROPE LTD.

Unit E, 11/F., Phase 1, Kaiser Estate
41 Man Yue Street
Hungghom, Kowloon, Hong Kong
Tel: (852) 2334 6310 • Fax: (852) 2334 8858

15191 Bledsoe Street
Sylmar, California 91342
Tel (818) 364-9800 • FAX (818) 364-6100
<http://www.johansondielectrics.com>

Acorn House, Old Kiln Road
Flackwell Heath, Bucks HP10 9NR
United Kingdom
Tel +44-162-853-1154 • Fax +44-162-853-2703