



Aluminum electrolytic capacitors

Series/Type: B41888

The following products presented in this data sheet are being withdrawn.

Ordering Code	Substitute Product	Date of Withdrawal	Deadline Last Orders	Last Shipments
B41888C8687M000		2018-06-22	2018-09-30	2018-12-31
B41888C7188M000		2018-06-22	2018-09-30	2018-12-31
B41888C6108M000		2018-06-22	2018-09-30	2018-12-31



Ordering Code	Substitute Product	Date of Withdrawal	Deadline Last Orders	Last Shipments
B41888C5278M000		2018-06-22	2018-09-30	2018-12-31
B41888C4398M000		2018-06-22	2018-09-30	2018-12-31
B41888C3568M000		2018-06-22	2018-09-30	2018-12-31

For further information please contact your nearest EPCOS sales office, which will also support you in selecting a suitable substitute. The addresses of our worldwide sales network are presented at www.epcos.com/sales.

Long-life grade capacitors
Low impedance
Applications

- Automotive electronics
- For use in switch-mode power supplies
- For professional industrial electronics, telecommunications and data processing equipment

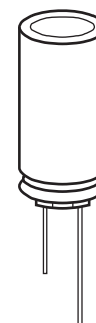
Features

- Long useful life
- Low impedance at high frequency
- High ripple current capability
- RoHS-compatible

Construction

- Radial leads
- Charge-discharge proof, polar
- Aluminum case with insulating sleeve
- Minus pole marking on the insulating sleeve
- Case with safety vent

Delivery mode

Terminal configurations and packing:

- Bulk
- Taped, Ammo pack
- Cut
- Kinked
- PAPER (Protection Against Polarity Reversal):
crimped leads, J leads, bent leads

Refer to chapter "Single-ended capacitors – Taping, packing and lead configurations" for further details.

Specifications and characteristics in brief

Rated voltage V_R	10 ... 63 V DC						
Surge voltage V_S	$1.15 \cdot V_R$						
Rated capacitance C_R	47 ... 10000 μF						
Capacitance tolerance	$\pm 20\% \triangleq M$						
Dissipation factor $\tan \delta$ (20 °C, 120 Hz)	For capacitance higher than 1000 μF add 0.02 for every increase of 1000 μF .						
	V_R (V DC)	10	16	25	35	50	63
	$\tan \delta$ (max.)	0.18	0.16	0.14	0.12	0.10	0.09
Leakage current I_{leak} (20 °C, 5 min)	$I_{\text{leak}} = 0.01 \mu\text{A} \cdot \left(\frac{C_R}{\mu\text{F}} \cdot \frac{V_R}{\text{V}} \right)$						
Self-inductance ESL	Diameter (mm)	≤ 12.5	16	18			
	ESL (nH)	20	26	34			
Useful life ¹⁾ 105 °C; V_R ; $I_{\text{AC,R}}$	<p>> 5000 h for $d = 8$ mm > 7000 h for $d = 10$ mm > 10000 h for $d \geq 12.5$ mm</p>						
Requirements	<p>$\Delta C/C \leq 40\%$ of initial value $\tan \delta \leq 3$ times initial specified limit $I_{\text{leak}} \leq$ initial specified limit</p>						
Voltage endurance test 105 °C; V_R	<p>5000 h for $d = 8$ mm 7000 h for $d = 10$ mm 10000 h for $d \geq 12.5$ mm</p>						
Post test requirements	<p>$\Delta C/C \leq 30\%$ of initial value $\tan \delta \leq 2$ times initial specified limit $I_{\text{leak}} \leq$ initial specified limit</p>						
Vibration resistance test	<p>To IEC 60068-2-6, test Fc: Frequency range 10 Hz ... 2 kHz, displacement amplitude max. 1.5 mm, acceleration max. 20 g, duration 3×2 h. Capacitor rigidly clamped by the aluminum case.</p>						
IEC climatic category	To IEC 60068-1: 55/105/56 (–55 °C/+105 °C/56 days damp heat test)						
Sectional specification	IEC 60384-4, AEC-Q200						

1) Refer to chapter "General technical information, 5 Useful life" on how to interpret useful life.



B41888

Long useful life – 105 °C

Dimensional drawings

With stand-off rubber seal

Diameters (mm): 10, 12.5, 16, 18

With flat rubber seal

Diameter (mm): 8

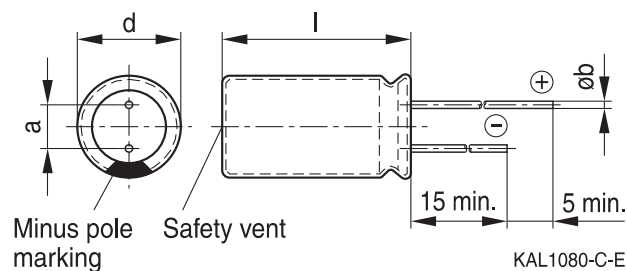
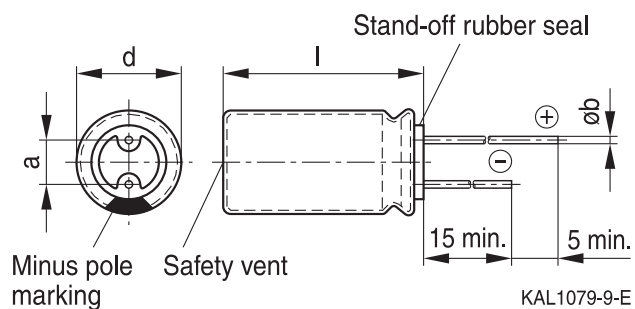

Dimensions and weights

Dimensions (mm)				Approx. weight
d +0.5	l	a ±0.5	b	g
8	11.5 +1.5	3.5	0.60 ±0.05	1.0
10	12.5 +1.0	5.0	0.60 ±0.05	1.6
10	16 +1.0	5.0	0.60 ±0.05	1.9
10	20 +2.0	5.0	0.60 ±0.05	2.6
12.5	20 +2.0	5.0	0.60 ±0.05	3.6
12.5	25 +2.0	5.0	0.60 ±0.05	4.5
12.5	40 +2.0	5.0	0.80 ±0.05	7.4
16	20 +2.0	7.5	0.80 ±0.05	5.5
16	25 +2.0	7.5	0.80 ±0.05	7.5
16	31.5 +2.0	7.5	0.80 ±0.05	7.8
16	35.5 +2.0	7.5	0.80 ±0.05	9.2
18	20 +2.0	7.5	0.80 ±0.1	8.0
18	25 +2.0	7.5	0.80 ±0.1	9.0
18	31.5 +2.0	7.5	0.80 ±0.1	11.0
18	35 +2.0	7.5	0.80 ±0.1	13.0
18	40 +2.0	7.5	0.80 ±0.1	16.0

Overview of available types

Other voltage and capacitance ratings are available upon request.

V_R (V DC)	10	16	25	35	50	63
	Case dimensions $d \times l$ (mm)					
C_R (μ F)						
47						8 × 11.5
100				8 × 11.5	8 × 11.5	10 × 12.5
120					8 × 11.5	10 × 16
150				8 × 11.5	10 × 12.5	10 × 16
180			8 × 11.5	10 × 12.5		10 × 20
220			8 × 11.5	10 × 12.5	10 × 16	10 × 20
270			8 × 11.5	10 × 12.5	10 × 20	12.5 × 20
330		8 × 11.5	10 × 12.5	10 × 16	10 × 20	12.5 × 20
390		8 × 11.5	10 × 12.5			12.5 × 25
470	8 × 11.5	10 × 12.5	10 × 16	10 × 20	12.5 × 20	16 × 20
560	10 × 12.5	10 × 16	10 × 16	10 × 20	12.5 × 25	16 × 20
680	10 × 12.5	10 × 16	10 × 20	10 × 20	12.5 × 25	12.5 × 40 16 × 25 18 × 20
820	10 × 16		10 × 20	12.5 × 20	16 × 20	16 × 31.5 18 × 25
1000	10 × 16	10 × 20	12.5 × 20	12.5 × 25	12.5 × 40 16 × 25 18 × 20	
1200	10 × 20	10 × 20	12.5 × 20	16 × 20	16 × 31.5 18 × 25	18 × 31.5
1500	10 × 20	12.5 × 20	12.5 × 25		16 × 31.5	18 × 35
1800	10 × 20	12.5 × 25	16 × 20	12.5 × 40 16 × 25 18 × 20	16 × 35.5 18 × 31.5	18 × 40
2200	12.5 × 20	12.5 × 25	18 × 20	16 × 31.5 18 × 25	18 × 35	
2700	12.5 × 25	16 × 20	12.5 × 40 16 × 25	16 × 31.5	18 × 40	
3300	12.5 × 25		16 × 31.5 18 × 25	16 × 35.5 18 × 31.5		
3900	16 × 20	12.5 × 40 16 × 25 18 × 20	16 × 35.5 18 × 31.5	18 × 35		



B41888

Long useful life – 105 °C

Overview of available types

Other voltage and capacitance ratings are available upon request.

V_R (V DC)	10	16	25	35	50	63
	Case dimensions $d \times l$ (mm)					
C_R (μ F)						
4700	16 \times 25	16 \times 31.5 18 \times 25	18 \times 35	18 \times 40		
5600	12.5 \times 40 16 \times 25 18 \times 20	18 \times 31.5	18 \times 40			
6800	16 \times 31.5 18 \times 25					
8200	18 \times 31.5	18 \times 35				
10000	18 \times 35	18 \times 40				

Technical data and ordering codes

C_R 120 Hz 20 °C μF	Case dimensions $d \times l$ mm	ESR_{max} 10 kHz –40 °C Ω	ESR_{max} 10 kHz 20 °C Ω	Z_{max} 100 kHz 20 °C Ω	$I_{\text{AC,R}}$ 100 kHz 105 °C mA	Ordering code (composition see below)
$V_R = 10 \text{ V DC}$						
470	8 × 11.5	1.630	0.204	0.183	690	B41888C3477M***
560	10 × 12.5	0.928	0.116	0.101	900	B41888C3567M***
680	10 × 12.5	0.930	0.116	0.101	900	B41888C3687M***
820	10 × 16	0.512	0.064	0.059	1240	B41888C3827M***
1000	10 × 16	0.516	0.064	0.059	1240	B41888C3108M***
1200	10 × 20	0.403	0.050	0.046	1500	B41888C3128M***
1500	10 × 20	0.400	0.050	0.046	1500	B41888C3158M***
1800	10 × 20	0.400	0.050	0.046	1500	B41888C3188M***
2200	12.5 × 20	0.328	0.041	0.039	2000	B41888D3228M***
2700	12.5 × 25	0.240	0.030	0.027	2459	B41888C3278M***
3300	12.5 × 25	0.237	0.030	0.027	2459	B41888C3338M***
3900	16 × 20	0.233	0.029	0.026	2530	B41888C3398M***
4700	16 × 25	0.190	0.024	0.022	2930	B41888C3478M***
5600	12.5 × 40	0.149	0.019	0.017	3350	B41888C3568M***
5600	16 × 25	0.190	0.024	0.022	2930	B41888D3568M***
5600	18 × 20	0.226	0.028	0.025	3000	B41888E3568M***
6800	16 × 31.5	0.154	0.019	0.017	3600	B41888C3688M***
6800	18 × 25	0.188	0.023	0.021	3396	B41888D3688M***
8200	18 × 31.5	0.143	0.018	0.016	4247	B41888C3828M***
10000	18 × 35	0.120	0.015	0.014	4300	B41888C3109M***

Composition of ordering code

*** = Version

- 000 = for standard leads, bulk
- 001 = for kinked leads, bulk (for $d \times l = 10 \times 20 \dots 12.5 \times 25$ mm and $\varnothing 16 \dots 18$ mm)
- 002 = for cut leads, bulk (for $\varnothing 10 \dots 18$ mm, excluding $d \times l = 12.5 \times 40$ mm)
- 003 = for crimped leads, blister (for $\varnothing 16 \dots 18$ mm)
- 004 = for J leads, blister (for $\varnothing 10 \dots 18$ mm, excluding $d \times l = 12.5 \times 40$ and 18×40 mm)
- 006 = for taped leads, Ammo pack, lead spacing $F = 3.5$ mm (for $\varnothing 8$ mm)
- 008 = for taped leads, Ammo pack, lead spacing $F = 5.0$ mm (for $d \times l = 8 \times 11.5 \dots 12.5 \times 25$ mm)
- 009 = for taped leads, Ammo pack, lead spacing $F = 7.5$ mm (for $d \times l = 16 \times 20 \dots 16 \times 31.5$ mm and $18 \times 20 \dots 18 \times 31.5$ mm)
- 012 = for bent 90° leads, blister (for $\varnothing 16 \dots 18$ mm)



B41888

Long useful life – 105 °C

Technical data and ordering codes

C_R 120 Hz 20 °C μF	Case dimensions $d \times l$ mm	ESR_{max} 10 kHz –40 °C Ω	ESR_{max} 10 kHz 20 °C Ω	Z_{max} 100 kHz 20 °C Ω	$I_{\text{AC,R}}$ 100 kHz 105 °C mA	Ordering code (composition see below)
$V_R = 16 \text{ V DC}$						
330	8 × 11.5	1.630	0.204	0.183	690	B41888C4337M***
390	8 × 11.5	1.632	0.204	0.183	690	B41888C4397M***
470	10 × 12.5	0.930	0.116	0.101	900	B41888C4477M***
560	10 × 16	0.512	0.064	0.059	1240	B41888C4567M***
680	10 × 16	0.516	0.064	0.059	1240	B41888C4687M***
1000	10 × 20	0.403	0.050	0.046	1500	B41888C4108M***
1200	10 × 20	0.400	0.050	0.046	1500	B41888C4128M***
1500	12.5 × 20	0.328	0.041	0.039	2000	B41888D4158M***
1800	12.5 × 25	0.240	0.030	0.027	2459	B41888C4188M***
2200	12.5 × 25	0.237	0.030	0.027	2459	B41888C4228M***
2700	16 × 20	0.233	0.029	0.026	2530	B41888C4278M***
3900	12.5 × 40	0.149	0.019	0.017	3350	B41888C4398M***
3900	16 × 25	0.190	0.024	0.022	2930	B41888D4398M***
3900	18 × 20	0.226	0.028	0.025	3000	B41888E4398M***
4700	16 × 31.5	0.154	0.019	0.017	3600	B41888C4478M***
4700	18 × 25	0.188	0.023	0.021	3200	B41888D4478M***
5600	18 × 31.5	0.143	0.018	0.016	4247	B41888C4568M***
8200	18 × 35	0.120	0.015	0.014	4300	B41888C4828M***
10000	18 × 40	0.100	0.013	0.012	5327	B41888C4109M***

Composition of ordering code

*** = Version

- 000 = for standard leads, bulk
- 001 = for kinked leads, bulk (for $d \times l = 10 \times 20 \dots 12.5 \times 25 \text{ mm}$ and $\varnothing 16 \dots 18 \text{ mm}$)
- 002 = for cut leads, bulk (for $\varnothing 10 \dots 18 \text{ mm}$, excluding $d \times l = 12.5 \times 40 \text{ mm}$)
- 003 = for crimped leads, blister (for $\varnothing 16 \dots 18 \text{ mm}$)
- 004 = for J leads, blister (for $\varnothing 10 \dots 18 \text{ mm}$, excluding $d \times l = 12.5 \times 40$ and $18 \times 40 \text{ mm}$)
- 006 = for taped leads, Ammo pack, lead spacing $F = 3.5 \text{ mm}$ (for $\varnothing 8 \text{ mm}$)
- 008 = for taped leads, Ammo pack, lead spacing $F = 5.0 \text{ mm}$ (for $d \times l = 8 \times 11.5 \dots 12.5 \times 25 \text{ mm}$)
- 009 = for taped leads, Ammo pack, lead spacing $F = 7.5 \text{ mm}$ (for $d \times l = 16 \times 20 \dots 16 \times 31.5 \text{ mm}$ and $18 \times 20 \dots 18 \times 31.5 \text{ mm}$)
- 012 = for bent 90° leads, blister (for $\varnothing 16 \dots 18 \text{ mm}$)

Technical data and ordering codes

C_R 120 Hz 20 °C μF	Case dimensions $d \times l$ mm	ESR_{max} 10 kHz –40 °C Ω	ESR_{max} 10 kHz 20 °C Ω	Z_{max} 100 kHz 20 °C Ω	$I_{\text{AC,R}}$ 100 kHz 105 °C mA	Ordering code (composition see below)
$V_R = 25 \text{ V DC}$						
180	8 × 11.5	1.795	0.224	0.201	658	B41888C5187M***
220	8 × 11.5	1.630	0.204	0.183	690	B41888C5227M***
270	8 × 11.5	1.632	0.204	0.183	690	B41888C5277M***
330	10 × 12.5	0.930	0.116	0.101	900	B41888C5337M***
390	10 × 12.5	0.928	0.116	0.101	900	B41888C5397M***
470	10 × 16	0.516	0.064	0.059	1240	B41888C5477M***
560	10 × 16	0.512	0.064	0.059	1240	B41888C5567M***
680	10 × 20	0.403	0.050	0.046	1500	B41888C5687M***
820	10 × 20	0.400	0.050	0.046	1500	B41888C5827M***
1000	12.5 × 20	0.328	0.041	0.039	2000	B41888D5108M***
1200	12.5 × 20	0.328	0.041	0.039	2000	B41888C5128M***
1500	12.5 × 25	0.237	0.030	0.027	2459	B41888C5158M***
1800	16 × 20	0.233	0.029	0.026	2530	B41888C5188M***
2200	18 × 20	0.226	0.028	0.025	3000	B41888C5228M***
2700	12.5 × 40	0.149	0.019	0.017	3350	B41888C5278M***
2700	16 × 25	0.190	0.024	0.022	2930	B41888D5278M***
3300	16 × 31.5	0.154	0.019	0.017	3600	B41888C5338M***
3300	18 × 25	0.188	0.023	0.021	3200	B41888D5338M***
3900	16 × 35.5	0.136	0.017	0.016	3700	B41888D5398M***
3900	18 × 31.5	0.143	0.018	0.016	4247	B41888C5398M***
4700	18 × 35	0.120	0.015	0.014	4300	B41888C5478M***
5600	18 × 40	0.100	0.013	0.012	5327	B41888C5568M***

Composition of ordering code

*** = Version

- 000 = for standard leads, bulk
- 001 = for kinked leads, bulk (for $d \times l = 10 \times 20 \dots 12.5 \times 25 \text{ mm}$ and $\varnothing 16 \dots 18 \text{ mm}$)
- 002 = for cut leads, bulk (for $\varnothing 10 \dots 18 \text{ mm}$, excluding $d \times l = 12.5 \times 40 \text{ mm}$)
- 003 = for crimped leads, blister (for $\varnothing 16 \dots 18 \text{ mm}$)
- 004 = for J leads, blister (for $\varnothing 10 \dots 18 \text{ mm}$, excluding $d \times l = 12.5 \times 40$ and $18 \times 40 \text{ mm}$)
- 006 = for taped leads, Ammo pack, lead spacing $F = 3.5 \text{ mm}$ (for $\varnothing 8 \text{ mm}$)
- 008 = for taped leads, Ammo pack, lead spacing $F = 5.0 \text{ mm}$ (for $d \times l = 8 \times 11.5 \dots 12.5 \times 25 \text{ mm}$)
- 009 = for taped leads, Ammo pack, lead spacing $F = 7.5 \text{ mm}$ (for $d \times l = 16 \times 20 \dots 16 \times 31.5 \text{ mm}$ and $18 \times 20 \dots 18 \times 31.5 \text{ mm}$)
- 012 = for bent 90° leads, blister (for $\varnothing 16 \dots 18 \text{ mm}$)



B41888

Long useful life – 105 °C

Technical data and ordering codes

C_R 120 Hz 20 °C μ F	Case dimensions $d \times l$ mm	ESR_{max} 10 kHz –40 °C Ω	ESR_{max} 10 kHz 20 °C Ω	Z_{max} 100 kHz 20 °C Ω	$I_{AC,R}$ 100 kHz 105 °C mA	Ordering code (composition see below)
$V_R = 35$ V DC						
100	8 × 11.5	1.795	0.224	0.201	658	B41888C7107M***
150	8 × 11.5	1.630	0.204	0.183	690	B41888C7157M***
180	10 × 12.5	0.928	0.116	0.101	900	B41888C7187M***
220	10 × 12.5	0.930	0.116	0.101	900	B41888C7227M***
270	10 × 12.5	0.928	0.116	0.101	900	B41888C7277M***
330	10 × 16	0.516	0.064	0.059	1240	B41888C7337M***
470	10 × 20	0.403	0.050	0.046	1500	B41888C7477M***
560	10 × 20	0.400	0.050	0.046	1500	B41888C7567M***
680	10 × 20	0.400	0.050	0.046	1500	B41888D7687M***
820	12.5 × 20	0.328	0.041	0.039	2000	B41888C7827M***
1000	12.5 × 25	0.237	0.030	0.027	2459	B41888C7108M***
1200	16 × 20	0.233	0.029	0.026	2530	B41888C7128M***
1800	12.5 × 40	0.149	0.019	0.017	3350	B41888C7188M***
1800	16 × 25	0.190	0.024	0.022	2930	B41888D7188M***
1800	18 × 20	0.226	0.028	0.025	3000	B41888E7188M***
2200	16 × 31.5	0.154	0.019	0.017	3600	B41888C7228M***
2200	18 × 25	0.188	0.023	0.021	3200	B41888D7228M***
2700	16 × 31.5	0.152	0.019	0.017	3600	B41888D7278M***
3300	16 × 35.5	0.136	0.017	0.016	3700	B41888E7338M***
3300	18 × 31.5	0.144	0.018	0.016	4247	B41888D7338M***
3900	18 × 35	0.120	0.015	0.014	4300	B41888D7398M***
4700	18 × 40	0.104	0.013	0.012	5327	B41888C7478M***

Composition of ordering code

*** = Version

- 000 = for standard leads, bulk
- 001 = for kinked leads, bulk (for $d \times l = 10 \times 20 \dots 12.5 \times 25$ mm and $\varnothing 16 \dots 18$ mm)
- 002 = for cut leads, bulk (for $\varnothing 10 \dots 18$ mm, excluding $d \times l = 12.5 \times 40$ mm)
- 003 = for crimped leads, blister (for $\varnothing 16 \dots 18$ mm)
- 004 = for J leads, blister (for $\varnothing 10 \dots 18$ mm, excluding $d \times l = 12.5 \times 40$ and 18×40 mm)
- 006 = for taped leads, Ammo pack, lead spacing $F = 3.5$ mm (for $\varnothing 8$ mm)
- 008 = for taped leads, Ammo pack, lead spacing $F = 5.0$ mm (for $d \times l = 8 \times 11.5 \dots 12.5 \times 25$ mm)
- 009 = for taped leads, Ammo pack, lead spacing $F = 7.5$ mm (for $d \times l = 16 \times 20 \dots 16 \times 31.5$ mm and $18 \times 20 \dots 18 \times 31.5$ mm)
- 012 = for bent 90° leads, blister (for $\varnothing 16 \dots 18$ mm)

Technical data and ordering codes

C_R 120 Hz 20 °C μF	Case dimensions $d \times l$ mm	ESR_{max} 10 kHz –40 °C Ω	ESR_{max} 10 kHz 20 °C Ω	Z_{max} 100 kHz 20 °C Ω	$I_{\text{AC,R}}$ 100 kHz 105 °C mA	Ordering code (composition see below)
$V_R = 50 \text{ V DC}$						
100	8 × 11.5	4.920	0.615	0.540	500	B41888C6107M***
120	8 × 11.5	4.920	0.615	0.540	500	B41888C6127M***
150	10 × 12.5	1.824	0.228	0.203	600	B41888D6157M***
220	10 × 16	1.030	0.129	0.115	1050	B41888C6227M***
270	10 × 20	0.672	0.084	0.075	1180	B41888C6277M***
330	10 × 20	0.672	0.084	0.075	1180	B41888C6337M***
470	12.5 × 20	0.518	0.065	0.060	1800	B41888C6477M***
560	12.5 × 25	0.344	0.043	0.040	2024	B41888C6567M***
680	12.5 × 25	0.344	0.043	0.040	2024	B41888C6687M***
820	16 × 20	0.410	0.051	0.046	1957	B41888C6827M***
1000	12.5 × 40	0.216	0.027	0.025	2920	B41888C6108M***
1000	16 × 25	0.283	0.035	0.032	2700	B41888D6108M***
1000	18 × 20	0.312	0.039	0.036	2541	B41888G6108M***
1200	16 × 31.5	0.221	0.028	0.025	3010	B41888C6128M***
1200	18 × 25	0.275	0.034	0.031	2795	B41888D6128M***
1500	16 × 31.5	0.224	0.028	0.025	3010	B41888C6158M***
1800	16 × 35.5	0.192	0.024	0.022	3230	B41888D6188M***
1800	18 × 31.5	0.204	0.025	0.023	3542	B41888C6188M***
2200	18 × 35	0.177	0.022	0.020	3800	B41888C6228M***
2700	18 × 40	0.159	0.020	0.018	4000	B41888C6278M***

Composition of ordering code

*** = Version

000 = for standard leads, bulk

 001 = for kinked leads, bulk (for $d \times l = 10 \times 20 \dots 12.5 \times 25 \text{ mm}$ and $\varnothing 16 \dots 18 \text{ mm}$)

 002 = for cut leads, bulk (for $\varnothing 10 \dots 18 \text{ mm}$, excluding $d \times l = 12.5 \times 40 \text{ mm}$)

 003 = for crimped leads, blister (for $\varnothing 16 \dots 18 \text{ mm}$)

 004 = for J leads, blister (for $\varnothing 10 \dots 18 \text{ mm}$, excluding $d \times l = 12.5 \times 40$ and $18 \times 40 \text{ mm}$)

 006 = for taped leads, Ammo pack, lead spacing $F = 3.5 \text{ mm}$ (for $\varnothing 8 \text{ mm}$)

 008 = for taped leads, Ammo pack, lead spacing $F = 5.0 \text{ mm}$ (for $d \times l = 8 \times 11.5 \dots 12.5 \times 25 \text{ mm}$)

 009 = for taped leads, Ammo pack, lead spacing $F = 7.5 \text{ mm}$ (for $d \times l = 16 \times 20 \dots 16 \times 31.5 \text{ mm}$ and $18 \times 20 \dots 18 \times 31.5 \text{ mm}$)

 012 = for bent 90° leads, blister (for $\varnothing 16 \dots 18 \text{ mm}$)



B41888

Long useful life – 105 °C

Technical data and ordering codes

C_R 120 Hz 20 °C μ F	Case dimensions $d \times l$ mm	ESR_{max} 10 kHz –40 °C Ω	ESR_{max} 10 kHz 20 °C Ω	Z_{max} 100 kHz 20 °C Ω	$I_{AC,R}$ 100 kHz 105 °C mA	Ordering code (composition see below)
$V_R = 63$ V DC						
47	8 × 11.5	4.328	0.541	0.488	283	B41888C8476M***
100	10 × 12.5	4.616	0.577	0.500	323	B41888C8107M***
120	10 × 16	3.075	0.308	0.279	474	B41888C8127M***
150	10 × 16	2.464	0.308	0.279	474	B41888C8157M***
180	10 × 20	1.986	0.199	0.180	644	B41888C8187M***
220	10 × 20	1.592	0.199	0.180	644	B41888C8227M***
270	12.5 × 20	1.688	0.169	0.153	800	B41888C8277M***
330	12.5 × 20	1.688	0.169	0.153	800	B41888C8337M***
390	12.5 × 25	1.236	0.124	0.112	1020	B41888C8397M***
470	16 × 20	1.037	0.104	0.094	1161	B41888C8477M***
560	16 × 20	0.832	0.104	0.094	1161	B41888C8567M***
680	12.5 × 40	0.717	0.072	0.065	1629	B41888C8687M***
680	16 × 25	0.772	0.077	0.070	1460	B41888D8687M***
680	18 × 20	0.960	0.096	0.087	1302	B41888E8687M***
820	16 × 31.5	0.541	0.054	0.049	1910	B41888C8827M***
820	18 × 25	0.761	0.076	0.069	1584	B41888D8827M***
1200	18 × 31.5	0.518	0.052	0.047	2094	B41888C8128M***
1500	18 × 35	0.441	0.044	0.040	2366	B41888C8158M***
1800	18 × 40	0.375	0.038	0.034	2708	B41888C8188M***

Composition of ordering code

*** = Version

- 000 = for standard leads, bulk
- 001 = for kinked leads, bulk (for $d \times l = 10 \times 20 \dots 12.5 \times 25$ mm and $\varnothing 16 \dots 18$ mm)
- 002 = for cut leads, bulk (for $\varnothing 10 \dots 18$ mm, excluding $d \times l = 12.5 \times 40$ mm)
- 003 = for crimped leads, blister (for $\varnothing 16 \dots 18$ mm)
- 004 = for J leads, blister (for $\varnothing 10 \dots 18$ mm, excluding $d \times l = 12.5 \times 40$ and 18×40 mm)
- 006 = for taped leads, Ammo pack, lead spacing $F = 3.5$ mm (for $\varnothing 8$ mm)
- 008 = for taped leads, Ammo pack, lead spacing $F = 5.0$ mm (for $d \times l = 8 \times 11.5 \dots 12.5 \times 25$ mm)
- 009 = for taped leads, Ammo pack, lead spacing $F = 7.5$ mm (for $d \times l = 16 \times 20 \dots 16 \times 31.5$ mm and $18 \times 20 \dots 18 \times 31.5$ mm)
- 012 = for bent 90° leads, blister (for $\varnothing 16 \dots 18$ mm)

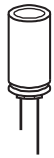

B41888
Long useful life – 105 °C

Useful life¹⁾

depending on ambient temperature T_A under ripple current operating conditions

$d = 8 \text{ mm}$

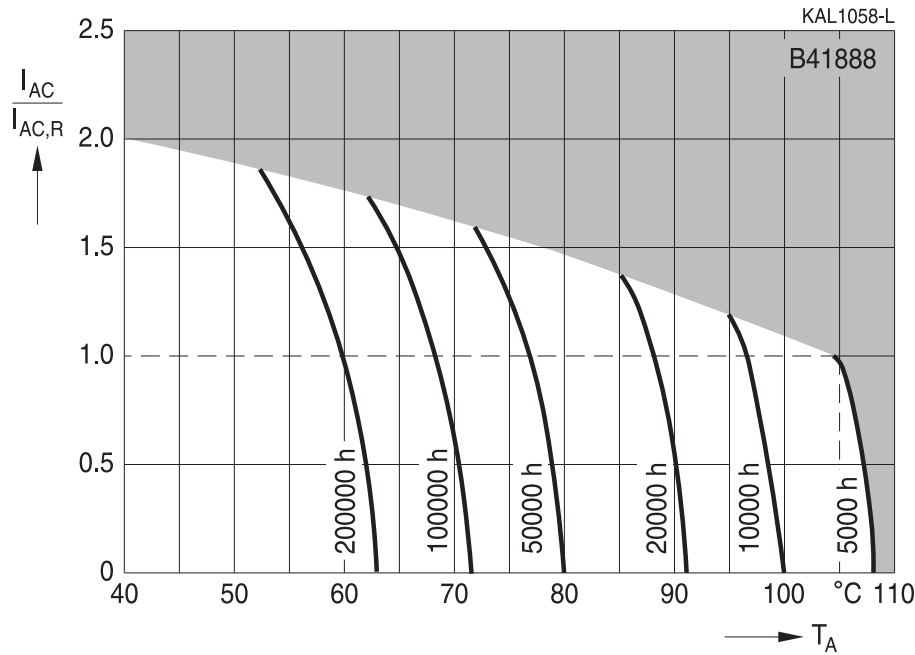

Useful life¹⁾

depending on ambient temperature T_A under ripple current operating conditions

$d = 10 \text{ mm}$

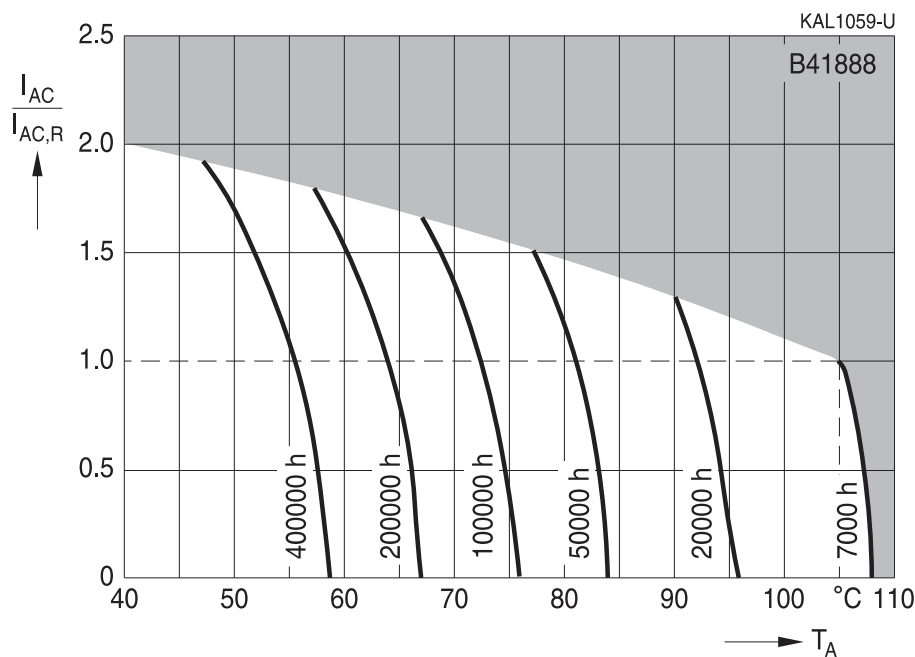

1) Refer to chapter "General technical information, 5 Useful life" on how to interpret useful life.

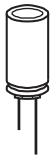

B41888

Long useful life – 105 °C

Useful life¹⁾

depending on ambient temperature T_A under ripple current operating conditions

$d \geq 12.5$ mm

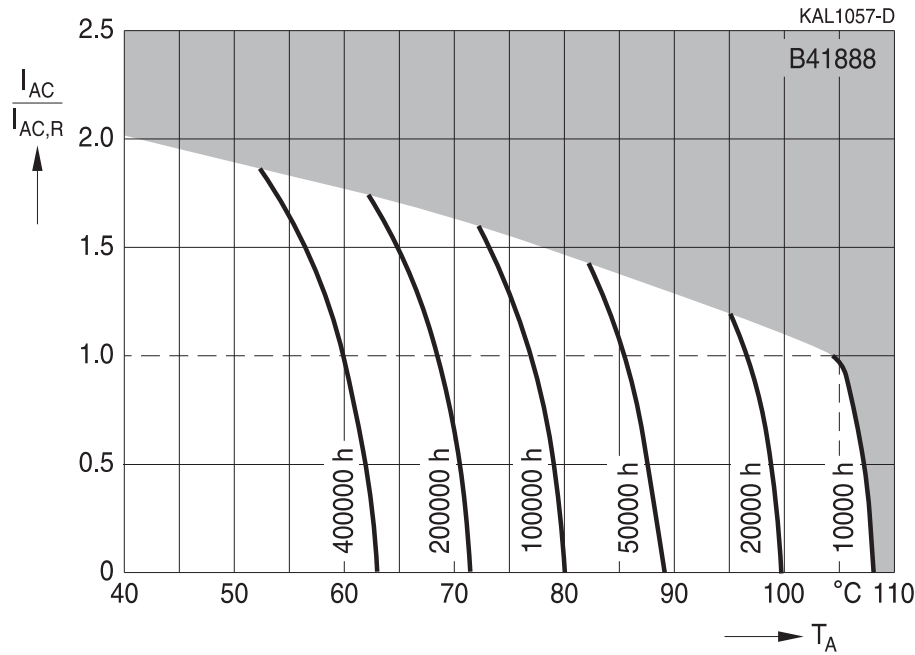

Frequency factor of permissible ripple current I_{AC} versus frequency f

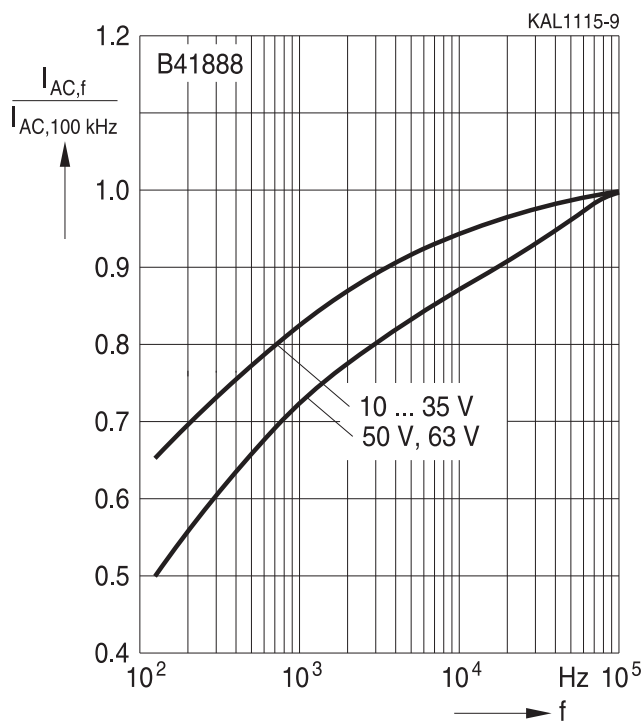

1) Refer to chapter "General technical information, 5 Useful life" on how to interpret useful life.



Taping, packing and lead configurations

Taping

Single-ended capacitors are available taped in Ammo pack from diameter 8 to 18 mm as follows:

Lead spacing $F = 3.5$ mm ($\varnothing d = 8$ mm)

Lead spacing $F = 5.0$ mm ($\varnothing d = 8 \dots 12.5$ mm)

Lead spacing $F = 7.5$ mm ($\varnothing d = 16 \dots 18$ mm).

The dimensions for F , P_1 and 1 max. are specified with reference to the center of the terminal wires.

Lead spacing 3.5 mm ($\varnothing d = 8$ mm)

Last 3 digits of ordering code: 006

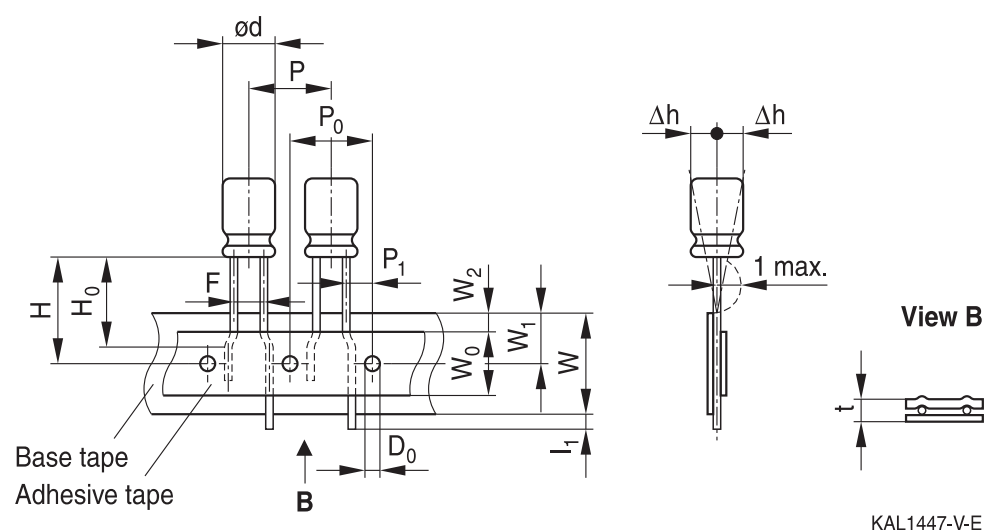

Dimensions in mm

$\varnothing d$	F	H	W	W_0	W_1	W_2	P	P_0	P_1	I_1	t	Δh	D_0
8	3.5	18.5	18.0	9.5	9.0	3.0	12.7	12.7	4.6	1.0	0.7	1.0	4.0
Tolerance	+0.8 -0.2	± 1.0	± 0.5	min.	± 0.5	max.	± 1.0	± 0.3	± 0.6	max.	± 0.2	max.	± 0.2

Leads can also run straight through the taping area.



B41888

Long useful life – 105 °C

Lead spacing 5.0 mm (∅ d = 8 mm)

Last 3 digits of ordering code: 008

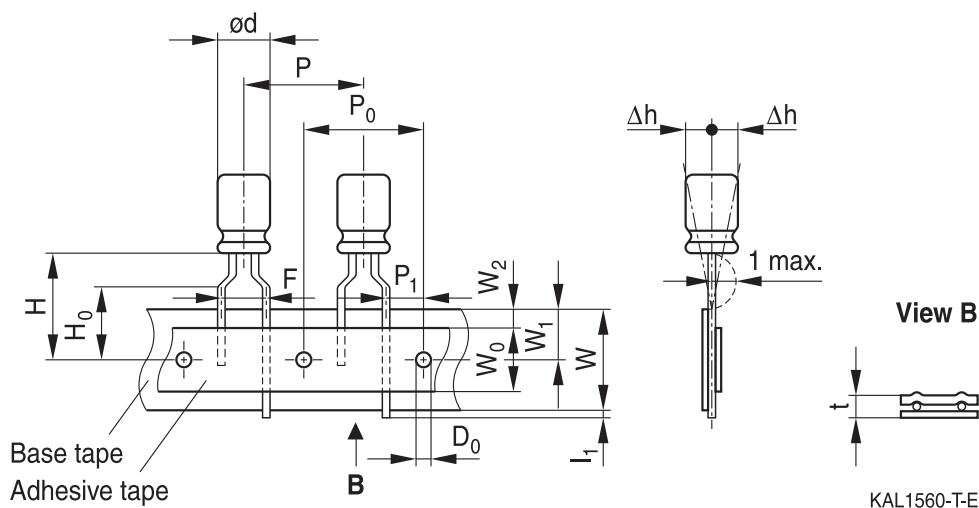

Lead spacing 5.0 mm (∅ d = 10 ... 12.5 mm)

Last 3 digits of ordering code: 008

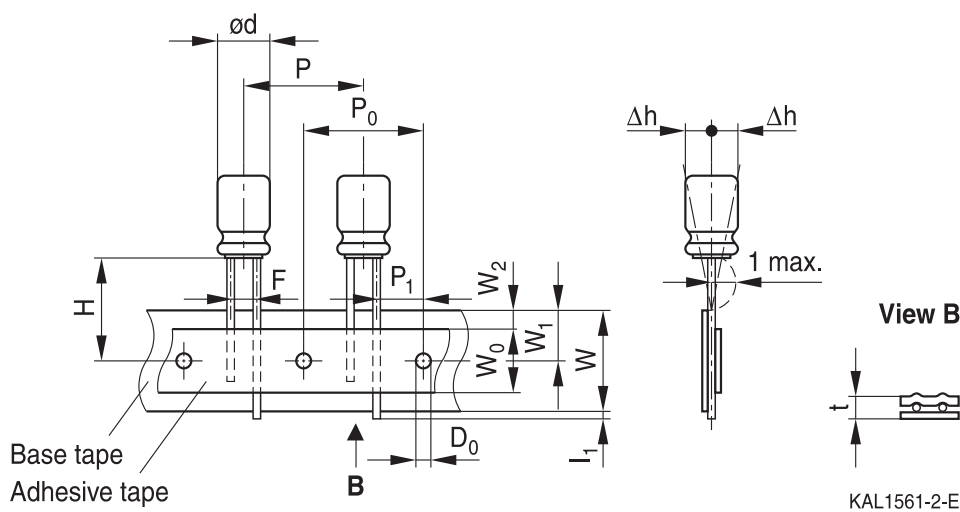

Dimensions in mm

∅ d	F	H	W	W ₀	W ₁	W ₂	H ₀	P	P ₀	P ₁	l ₁	t	Δh	D ₀
8	5.0	20.0	18.0	9.5	9.0	1.5	16.0	12.7	12.7	3.85	1.0	0.6	1.0	4.0
10		19.0		9.5			–	12.7	12.7	3.85				
12.5		19.0		11.5			–	15.0	15.0	5.0				
Tolerance	+0.8 –0.2	±0.75	±0.5	min.	±0.5	max.	±0.5	±1.0	±0.2	±0.5	max.	+0.3 –0.2	max.	±0.2

Taping is available up to dimensions d × l = 12.5 × 25 mm.

Lead spacing 7.5 mm (∅ d = 16 ...18 mm)

Last 3 digits of ordering code: 009

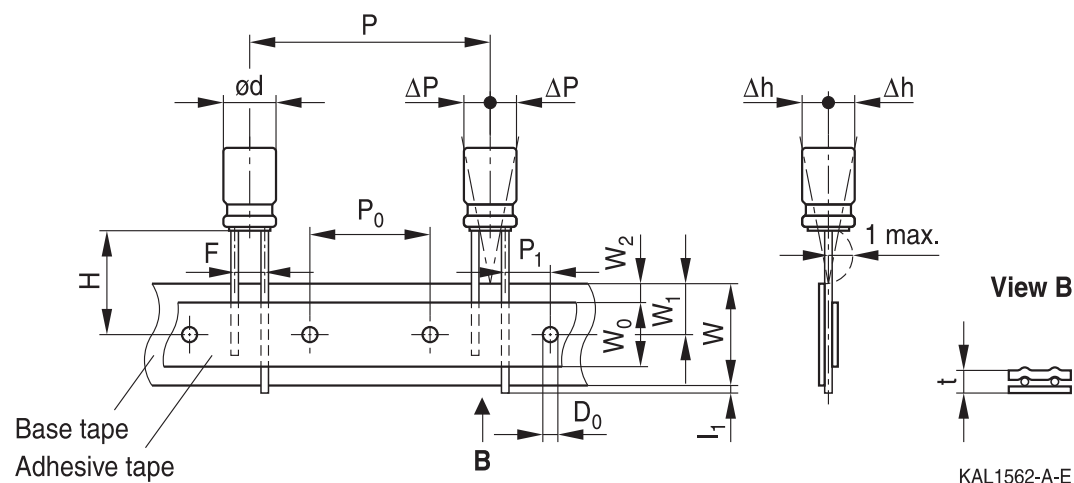

KAL1562-A-E

Dimensions in mm

∅ d	F	H	W	W ₀	W ₁	W ₂	P	P ₀	P ₁	l ₁	t	ΔP	Δh	D ₀
16	7.5	18.5	18.0	12.5	9.0	1.5	30.0	15.0	3.75	1.0	0.7	0	0	4.0
18														
Tolerance	±0.8	-0.5 +0.75	±0.5	min.	±0.5	max.	±1.0	±0.2	±0.5	max.	±0.2	±1.0	±1.0	±0.2

Taping is available up to dimensions d × l = 16 × 31.5 mm and 18 × 31.5 mm.



B41888

Long useful life – 105 °C

Cut or kinked leads

Single-ended capacitors are available with cut or kinked leads. Other lead configurations also available upon request.

Cut leads

Last 3 digits of ordering code: 002

With stand-off rubber seal

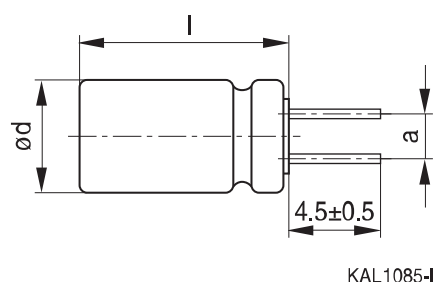

With flat rubber seal

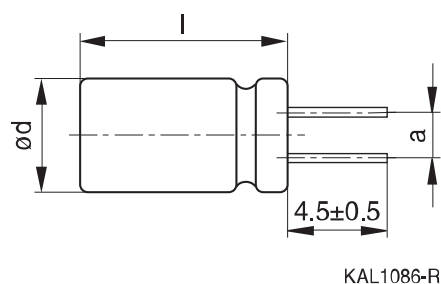

Case size d × l (mm)	Dimensions (mm) a ±0.5
10 × 12.5	5.0
10 × 16	5.0
10 × 20	5.0
12.5 × 20	5.0
12.5 × 25	5.0
16 × 20	7.5
16 × 25	7.5
16 × 31.5	7.5
16 × 35.5	7.5
18 × 20	7.5
18 × 25	7.5
18 × 31.5	7.5
18 × 35	7.5
18 × 40	7.5



Kinked leads

Last 3 digits of ordering code: 001

With stand-off rubber seal

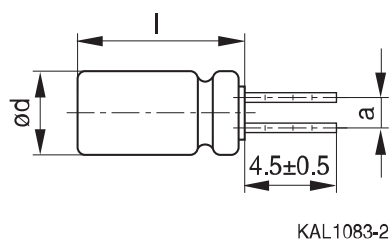
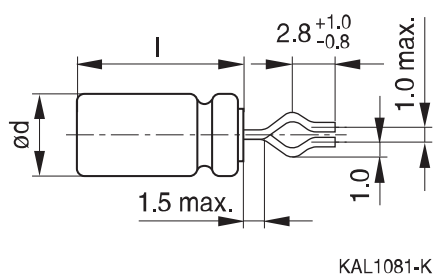

With flat rubber seal

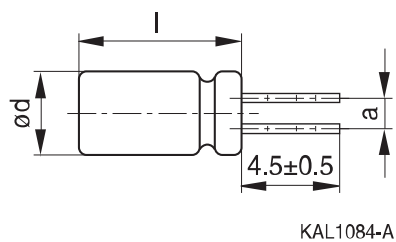
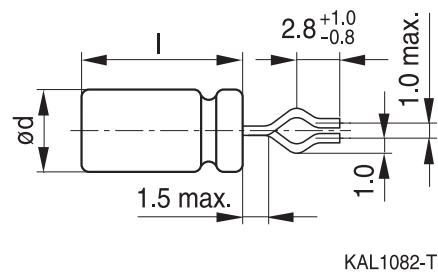

Case size d × l (mm)	Dimensions (mm) a ±0.5
10 × 20	5.0
12.5 × 20	5.0
12.5 × 25	5.0
16 × 20	7.5
16 × 25	7.5
16 × 31.5	7.5
16 × 35.5	7.5
18 × 20	7.5
18 × 25	7.5
18 × 31.5	7.5
18 × 35	7.5
18 × 40	7.5



B41888

Long useful life – 105 °C

PAPR leads (Protection Against Polarity Reversal)

These lead configurations ensure correct placement of the capacitor on the PCB with regard to polarity. PAPR leads are available for diameters from 10 mm up to 18 mm (excluding $d \times l = 12.5 \times 30/35/40$ mm).

There are three configurations available: Crimped leads, J leads, bent 90° leads.

Crimped leads

Last 3 digits of ordering code: 003

With stand-off rubber seal

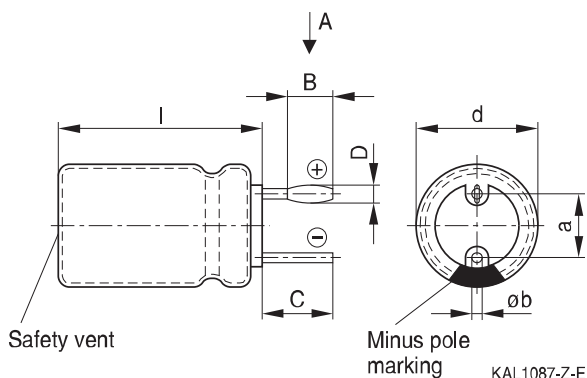

The series B41898 has no sleeve nor minus pole marking, the positive pole is marked on the aluminum case side instead.

Suggestion for PCB hole diameter

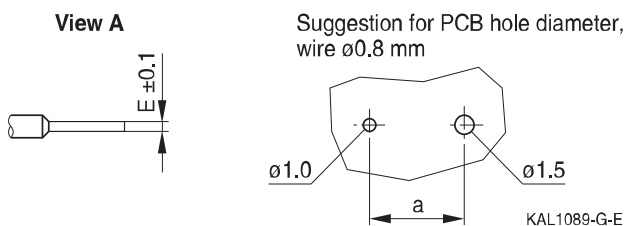

Case size $d \times l$ (mm)	Dimensions (mm)					
	$B \pm 0.2$	$C \pm 0.5$	$D \pm 0.1$	$E \pm 0.1$	$a \pm 0.5$	$\varnothing b$
16 × 20	1.5	3.0	1.3	0.3	7.5	0.8 ± 0.05
16 × 25	1.5	3.0	1.3	0.3	7.5	0.8 ± 0.05
16 × 31.5	1.5	3.0	1.3	0.3	7.5	0.8 ± 0.05
16 × 35.5	1.5	3.0	1.3	0.3	7.5	0.8 ± 0.05
18 × 20	1.5	3.0	1.3	0.3	7.5	0.8 ± 0.1
18 × 25	1.5	3.0	1.3	0.3	7.5	0.8 ± 0.1
18 × 31.5	1.5	3.0	1.3	0.3	7.5	0.8 ± 0.1
18 × 35	1.5	3.0	1.3	0.3	7.5	0.8 ± 0.1
18 × 40	1.5	3.0	1.3	0.3	7.5	0.8 ± 0.1

J leads

Last 3 digits of ordering code: 004

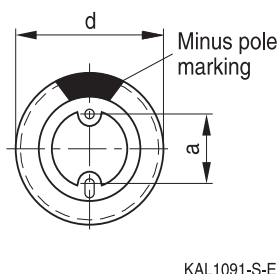
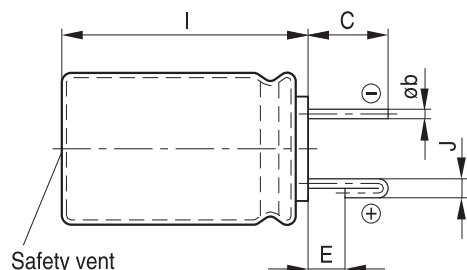

The series B41898 has no sleeve nor minus pole marking, the positive pole is marked on the aluminum case side instead.

KAL1091-S-E

Suggestion for PCB hole diameter

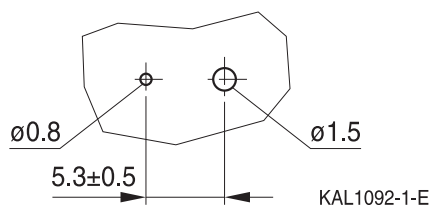
 Suggestion for PCB hole diameter, wire $\varnothing 0.6$ mm

KAL1092-1-E

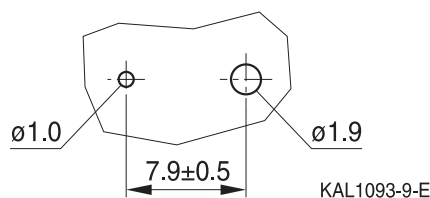
 Suggestion for PCB hole diameter, wire $\varnothing 0.8$ mm

KAL1093-9-E

Case size $d \times l$ (mm)	Dimensions (mm)				
	$C \pm 0.5$	$E \pm 0.5$	$J \pm 0.2$	$a \pm 0.5$	$\varnothing b$
10 × 12.5	3.2	0.7	1.2	5.0	0.6 ± 0.05
10 × 16	3.2	0.7	1.2	5.0	0.6 ± 0.05
10 × 20	3.2	0.7	1.2	5.0	0.6 ± 0.05
12.5 × 20	3.2	0.7	1.2	5.0	0.6 ± 0.05
12.5 × 25	3.2	0.7	1.2	5.0	0.6 ± 0.05
16 × 20	3.5	0.7	1.6	7.5	0.8 ± 0.05
16 × 25	3.5	0.7	1.6	7.5	0.8 ± 0.05
16 × 31.5	3.5	0.7	1.6	7.5	0.8 ± 0.05
16 × 35.5	3.5	0.7	1.6	7.5	0.8 ± 0.05
18 × 20	3.5	0.7	1.6	7.5	0.8 ± 0.1
18 × 25	3.5	0.7	1.6	7.5	0.8 ± 0.1
18 × 31.5	3.5	0.7	1.6	7.5	0.8 ± 0.1
18 × 35	3.5	0.7	1.6	7.5	0.8 ± 0.1



B41888

Long useful life – 105 °C

Bent 90° leads for horizontal mounting pinning

Last 3 digits of ordering code: 012

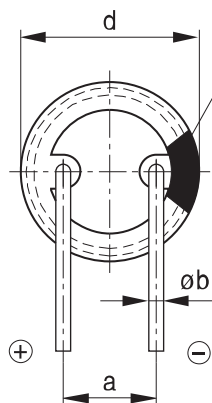
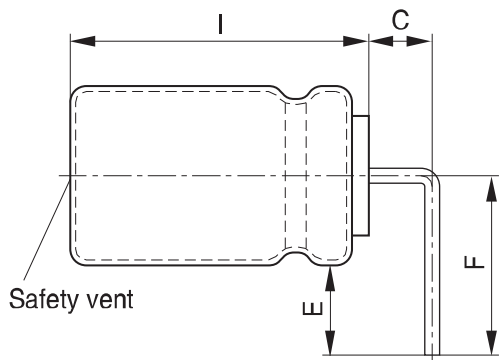

Minus pole marking
 The series B41898 has no sleeve nor minus pole marking, the positive pole is marked on the aluminum case side instead.

KAL1094-H-E

Case size d × l (mm)	Dimensions (mm)				
	C ±0.5	E ±0.5	F ±0.5	a ±0.5	Øb
16 × 20	4.0	4.0	12.0	7.5	0.8 ±0.05
16 × 25	4.0	4.0	12.0	7.5	0.8 ±0.05
16 × 31.5	4.0	4.0	12.0	7.5	0.8 ±0.05
16 × 35.5	4.0	4.0	12.0	7.5	0.8 ±0.05
18 × 20	4.0	4.0	13.0	7.5	0.8 ±0.1
18 × 25	4.0	4.0	13.0	7.5	0.8 ±0.1
18 × 31.5	4.0	4.0	13.0	7.5	0.8 ±0.1
18 × 35	4.0	4.0	13.0	7.5	0.8 ±0.1
18 × 40	4.0	4.0	13.0	7.5	0.8 ±0.1

Bent leads for diameter 12.5 mm available upon request.



Packing units and box dimensions

Ammo pack

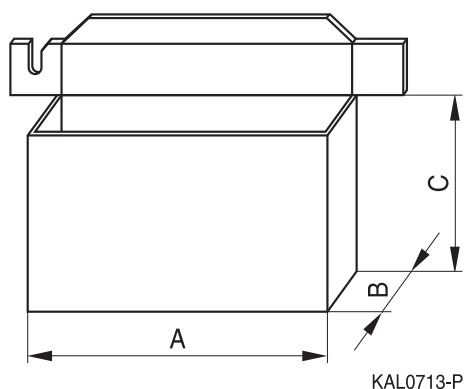

Case size d × l mm	Dimensions (mm)			Packing units pcs.
	A _{max}	B _{max}	C _{max}	
8 × 11.5	345	60	240	1000
10 × 12.5	345	60	280	750
10 × 16	345	65	200	500
10 × 20	345	65	200	500
12.5 × 20	345	65	260	500
12.5 × 25	345	70	260	500
16 × 20	325	65	285	300
16 × 25	325	65	285	300
16 × 31.5	325	80	275	300
18 × 20	325	65	285	250
18 × 25	325	65	285	250
18 × 31.5	325	80	275	250



B41888

Long useful life – 105 °C

Overview of packing units and code numbers

Case size d × l mm	Stan- dard, bulk pcs.	Taped, Ammo pack pcs.			Kinked leads, bulk pcs.	Cut leads, bulk pcs.	PAPR		
							Crimped leads, blister pcs.	J leads, blister pcs.	Bent 90° leads, blister pcs.
8 × 11.5	1000	1000			–	–	–	–	
10 × 12.5	1000	750			–	1000	–	900	
10 × 16	1000	500			–	1000	–	675	
10 × 20	500	500			500	500	–	500	
12.5 × 20	350	500			350	350	–	300	1)
12.5 × 25	250	500			500	500	–	225	1)
12.5 × 30	200	–			–	–	–	–	
12.5 × 35	175	–			–	–	–	–	
12.5 × 40	175	–			–	–	–	–	
16 × 20	250	300			200	200	200	200	420
16 × 25	250	300			200	200	216	216	216
16 × 31.5	200	300			250	250	180	180	180
16 × 35.5	100	–			100	100	150	150	150
18 × 20	175	250			175	175	200	200	420
18 × 25	150	250			150	150	200	200	200
18 × 31.5	100	250			100	100	150	150	150
18 × 35	100	–			100	100	150	150	150
18 × 40	125	–			100	100	72	–	72
The last three digits of the complete ordering code state the lead configuration	000	Code	F (mm)	d (mm)	001	002	003	004	012
		006	3.5	8					
		008	5	8...12.5					
		009	7.5	16...18					

1) Available upon request



Cautions and warnings

Personal safety

The electrolytes used by EPCOS have been optimized both with a view to the intended application and with regard to health and environmental compatibility. They do not contain any solvents that are detrimental to health, e.g. dimethyl formamide (DMF) or dimethyl acetamide (DMAC).

Furthermore, some of the high-voltage electrolytes used by EPCOS are self-extinguishing.

As far as possible, EPCOS does not use any dangerous chemicals or compounds to produce operating electrolytes, although in exceptional cases, such materials must be used in order to achieve specific physical and electrical properties because no alternative materials are currently known. We do, however, restrict the amount of dangerous materials used in our products to an absolute minimum.

Materials and chemicals used in EPCOS aluminum electrolytic capacitors are continuously adapted in compliance with the EPCOS Corporate Environmental Policy and the latest EU regulations and guidelines such as RoHS, REACH/SVHC, GADSL, and ELV.

MDS (Material Data Sheets) are available on the EPCOS website for all types listed in the data book. MDS for customer specific capacitors are available upon request.

MSDS (Material Safety Data Sheets) are available for all of our electrolytes upon request.

Nevertheless, the following rules should be observed when handling aluminum electrolytic capacitors: No electrolyte should come into contact with eyes or skin. If electrolyte does come into contact with the skin, wash the affected areas immediately with running water. If the eyes are affected, rinse them for 10 minutes with plenty of water. If symptoms persist, seek medical treatment. Avoid inhaling electrolyte vapor or mists. Workplaces and other affected areas should be well ventilated. Clothing that has been contaminated by electrolyte must be changed and rinsed in water.



B41888

Long useful life – 105 °C

Product safety

The table below summarizes the safety instructions that must be observed without fail. A detailed description can be found in the relevant sections of chapter "General technical information".

Topic	Safety information	Reference chapter "General technical information"
Polarity	Make sure that polar capacitors are connected with the right polarity.	1 "Basic construction of aluminum electrolytic capacitors"
Reverse voltage	Voltages of opposite polarity should be prevented by connecting a diode.	3.1.6 "Reverse voltage"
Mounting position of screw-terminal capacitors	Screw terminal capacitors must not be mounted with terminals facing down unless otherwise specified.	11.1. "Mounting positions of capacitors with screw terminals"
Robustness of terminals	The following maximum tightening torques must not be exceeded when connecting screw terminals: M5: 2.5 Nm M6: 4.0 Nm	11.3 "Mounting torques"
Mounting of single-ended capacitors	The internal structure of single-ended capacitors might be damaged if excessive force is applied to the lead wires. Avoid any compressive, tensile or flexural stress. Do not move the capacitor after soldering to PC board. Do not pick up the PC board by the soldered capacitor. Do not insert the capacitor on the PC board with a hole space different to the lead space specified.	11.4 "Mounting considerations for single-ended capacitors"
Soldering	Do not exceed the specified time or temperature limits during soldering.	11.5 "Soldering"
Soldering, cleaning agents	Do not allow halogenated hydrocarbons to come into contact with aluminum electrolytic capacitors.	11.6 "Cleaning agents"
Upper category temperature	Do not exceed the upper category temperature.	7.2 "Maximum permissible operating temperature"
Passive flammability	Avoid external energy, e.g. fire.	8.1 "Passive flammability"



Topic	Safety information	Reference chapter "General technical information"
Active flammability	Avoid overload of the capacitors.	8.2 "Active flammability"
Maintenance	Make periodic inspections of the capacitors. Before the inspection, make sure that the power supply is turned off and carefully discharge the capacitors. Do not apply excessive mechanical stress to the capacitor terminals when mounting.	10 "Maintenance"
Storage	Do not store capacitors at high temperatures or high humidity. Capacitors should be stored at +5 to +35 °C and a relative humidity of ≤ 75%.	7.3 "Shelf life and storage conditions"
		Reference chapter "Capacitors with screw terminals"
Breakdown strength of insulating sleeves	Do not damage the insulating sleeve, especially when ring clips are used for mounting.	"Screw terminals – accessories"

Display of ordering codes for EPCOS products

The ordering code for one and the same product can be represented differently in data sheets, data books, other publications and the website of EPCOS, or in order-related documents such as shipping notes, order confirmations and product labels. The varying representations of the ordering codes are due to different processes employed and do not affect the specifications of the respective products.

Detailed information can be found on the Internet under www.epcos.com/orderingcodes.



B41888

Long useful life – 105 °C

Symbols and terms

Symbol	English	German
C	Capacitance	Kapazität
C_R	Rated capacitance	Nennkapazität
C_S	Series capacitance	Serienkapazität
$C_{S,T}$	Series capacitance at temperature T	Serienkapazität bei Temperatur T
C_f	Capacitance at frequency f	Kapazität bei Frequenz f
d	Case diameter, nominal dimension	Gehäusedurchmesser, Nennmaß
d_{max}	Maximum case diameter	Maximaler Gehäusedurchmesser
ESL	Self-inductance	Eigeninduktivität
ESR	Equivalent series resistance	Ersatzserienwiderstand
ESR_f	Equivalent series resistance at frequency f	Ersatzserienwiderstand bei Frequenz f
ESR_T	Equivalent series resistance at temperature T	Ersatzserienwiderstand bei Temperatur T
f	Frequency	Frequenz
I	Current	Strom
I_{AC}	Alternating current (ripple current)	Wechselstrom
$I_{AC,RMS}$	Root-mean-square value of alternating current	Wechselstrom, Effektivwert
$I_{AC,f}$	Ripple current at frequency f	Wechselstrom bei Frequenz f
$I_{AC,max}$	Maximum permissible ripple current	Maximal zulässiger Wechselstrom
$I_{AC,R}$	Rated ripple current	Nennwechselstrom
I_{leak}	Leakage current	Reststrom
$I_{leak,op}$	Operating leakage current	Betriebsreststrom
l	Case length, nominal dimension	Gehäuselänge, Nennmaß
l_{max}	Maximum case length (without terminals and mounting stud)	Maximale Gehäuselänge (ohne Anschlüsse und Gewindebolzen)
R	Resistance	Widerstand
R_{ins}	Insulation resistance	Isolationswiderstand
R_{symm}	Balancing resistance	Symmetrierwiderstand
T	Temperature	Temperatur
ΔT	Temperature difference	Temperaturdifferenz
T_A	Ambient temperature	Umgebungstemperatur
T_C	Case temperature	Gehäusetemperatur
T_B	Capacitor base temperature	Temperatur des Gehäusebodens
t	Time	Zeit
Δt	Period	Zeitraum
t_b	Service life (operating hours)	Brauchbarkeitsdauer (Betriebszeit)



Symbol	English	German
V	Voltage	Spannung
V _F	Forming voltage	Formierspannung
V _{op}	Operating voltage	Betriebsspannung
V _R	Rated voltage, DC voltage	Nennspannung, Gleichspannung
V _S	Surge voltage	Spitzenspannung
X _C	Capacitive reactance	Kapazitiver Blindwiderstand
X _L	Inductive reactance	Induktiver Blindwiderstand
Z	Impedance	Scheinwiderstand
Z _T	Impedance at temperature T	Scheinwiderstand bei Temperatur T
tan δ	Dissipation factor	Verlustfaktor
λ	Failure rate	Ausfallrate
ε ₀	Absolute permittivity	Elektrische Feldkonstante
ε _r	Relative permittivity	Dielektrizitätszahl
ω	Angular velocity; 2 · π · f	Kreisfrequenz; 2 · π · f

Note

All dimensions are given in mm.

Important notes

The following applies to all products named in this publication:

1. Some parts of this publication contain **statements about the suitability of our products for certain areas of application**. These statements are based on our knowledge of typical requirements that are often placed on our products in the areas of application concerned. We nevertheless expressly point out **that such statements cannot be regarded as binding statements about the suitability of our products for a particular customer application**. As a rule we are either unfamiliar with individual customer applications or less familiar with them than the customers themselves. For these reasons, it is always ultimately incumbent on the customer to check and decide whether a product with the properties described in the product specification is suitable for use in a particular customer application.
2. We also point out that **in individual cases, a malfunction of electronic components or failure before the end of their usual service life cannot be completely ruled out in the current state of the art, even if they are operated as specified**. In customer applications requiring a very high level of operational safety and especially in customer applications in which the malfunction or failure of an electronic component could endanger human life or health (e.g. in accident prevention or life-saving systems), it must therefore be ensured by means of suitable design of the customer application or other action taken by the customer (e.g. installation of protective circuitry or redundancy) that no injury or damage is sustained by third parties in the event of malfunction or failure of an electronic component.
3. **The warnings, cautions and product-specific notes must be observed.**
4. In order to satisfy certain technical requirements, **some of the products described in this publication may contain substances subject to restrictions in certain jurisdictions (e.g. because they are classed as hazardous)**. Useful information on this will be found in our Material Data Sheets on the Internet (www.tdk-electronics.tdk.com/material). Should you have any more detailed questions, please contact our sales offices.
5. We constantly strive to improve our products. Consequently, **the products described in this publication may change from time to time**. The same is true of the corresponding product specifications. Please check therefore to what extent product descriptions and specifications contained in this publication are still applicable before or when you place an order.

We also **reserve the right to discontinue production and delivery of products**. Consequently, we cannot guarantee that all products named in this publication will always be available. The aforementioned does not apply in the case of individual agreements deviating from the foregoing for customer-specific products.

6. Unless otherwise agreed in individual contracts, **all orders are subject to our General Terms and Conditions of Supply**.
7. **Our manufacturing sites serving the automotive business apply the IATF 16949 standard**. The IATF certifications confirm our compliance with requirements regarding the quality management system in the automotive industry. Referring to customer requirements and customer specific requirements ("CSR") TDK always has and will continue to have the policy of respecting individual agreements. Even if IATF 16949 may appear to support the acceptance of unilateral requirements, we hereby like to emphasize that **only requirements mutually agreed upon can and will be implemented in our Quality Management System**. For clarification purposes we like to point out that obligations from IATF 16949 shall only become legally binding if individually agreed upon.

Important notes

8. The trade names EPCOS, CeraCharge, CeraDiode, CeraLink, CeraPad, CeraPlas, CSMP, CTVS, DeltaCap, DigiSiMic, ExoCore, FilterCap, FormFit, LeaXield, MiniBlue, MiniCell, MKD, MKK, MotorCap, PCC, PhaseCap, PhaseCube, PhaseMod, PhiCap, PowerHap, PQSine, PQvar, SIFERRIT, SIFI, SIKOREL, SilverCap, SIMDAD, SiMic, SIMID, SineFormer, SIOV, ThermoFuse, WindCap are **trademarks registered or pending** in Europe and in other countries. Further information will be found on the Internet at www.tdk-electronics.tdk.com/trademarks.

Release 2018-10