

## Triacs logic level

## BT136 series D

### GENERAL DESCRIPTION

Glass passivated, sensitive gate triacs in a plastic envelope, intended for use in general purpose bidirectional switching and phase control applications. These devices are intended to be interfaced directly to microcontrollers, logic integrated circuits and other low power gate trigger circuits.

### QUICK REFERENCE DATA

SYMBOL	PARAMETER	MAX.	MAX.	UNIT
$V_{DRM}$	<b>BT136-</b> Repetitive peak off-state voltages RMS on-state current Non-repetitive peak on-state current	<b>500D</b> 500	<b>600D</b> 600	V
$I_{T(RMS)}$		4	4	A
$I_{TSM}$		25	25	A

### PINNING - TO220AB

PIN	DESCRIPTION
1	main terminal 1
2	main terminal 2
3	gate
tab	main terminal 2

### PIN CONFIGURATION

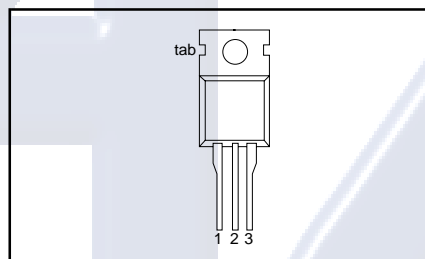

### SYMBOL

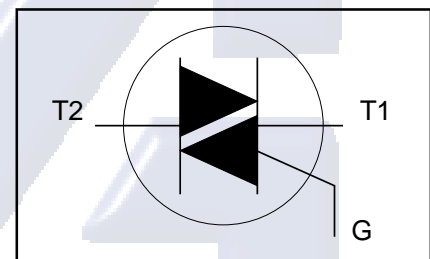

### LIMITING VALUES

Limiting values in accordance with the Absolute Maximum System (IEC 134).

SYMBOL	PARAMETER	CONDITIONS	MIN.	MAX.		UNIT
				-500 500 <sup>1</sup>	-600 600 <sup>1</sup>	
$V_{DRM}$	Repetitive peak off-state voltages		-	-500 500 <sup>1</sup>	-600 600 <sup>1</sup>	V
$I_{T(RMS)}$	RMS on-state current	full sine wave; $T_{mb} \leq 107^\circ\text{C}$	-	4		A
$I_{TSM}$	Non-repetitive peak on-state current	full sine wave; $T_j = 25^\circ\text{C}$ prior to surge	-	25		A
		$t = 20\text{ ms}$	-	27		A
		$t = 16.7\text{ ms}$	-	3.1		A <sup>2</sup> s
		$t = 10\text{ ms}$	-	3.1		A <sup>2</sup> s
$I^2t$	$I^2t$ for fusing		-	50		A/μs
$di_T/dt$	Repetitive rate of rise of on-state current after triggering	$I_{TM} = 6\text{ A}$ ; $I_G = 0.2\text{ A}$ ; $di_G/dt = 0.2\text{ A}/\mu\text{s}$	-	50		A/μs
		T2+ G+	-	50		A/μs
		T2+ G-	-	50		A/μs
		T2- G-	-	50		A/μs
		T2- G+	-	10		A/μs
$I_{GM}$	Peak gate current		-	2		A
$V_{GM}$	Peak gate voltage		-	5		V
$P_{GM}$	Peak gate power		-	5		W
$P_{G(AV)}$	Average gate power	over any 20 ms period	-	0.5		W
$T_{stg}$	Storage temperature		-40	150		°C
$T_j$	Operating junction temperature		-	125		°C

<sup>1</sup> Although not recommended, off-state voltages up to 800V may be applied without damage, but the triac may switch to the on-state. The rate of rise of current should not exceed 3 A/μs.

Triacs  
logic level

## BT136 series D

## THERMAL RESISTANCES

SYMBOL	PARAMETER	CONDITIONS	MIN.	TYP.	MAX.	UNIT
$R_{th\ j-mb}$	Thermal resistance junction to mounting base	full cycle	-	-	3.0	K/W
		half cycle	-	-	3.7	K/W
$R_{th\ j-a}$	Thermal resistance junction to ambient	in free air	-	60	-	K/W

## STATIC CHARACTERISTICS

 $T_j = 25\text{ °C}$  unless otherwise stated

SYMBOL	PARAMETER	CONDITIONS	MIN.	TYP.	MAX.	UNIT
$I_{GT}$	Gate trigger current	$V_D = 12\text{ V}; I_T = 0.1\text{ A}$				
		T2+ G+	-	2.0	5	mA
		T2+ G-	-	2.5	5	mA
		T2- G-	-	2.5	5	mA
		T2- G+	-	5.0	10	mA
$I_L$	Latching current	$V_D = 12\text{ V}; I_{GT} = 0.1\text{ A}$				
		T2+ G+	-	1.6	10	mA
		T2+ G-	-	4.5	15	mA
		T2- G-	-	1.2	10	mA
		T2- G+	-	2.2	15	mA
$I_H$	Holding current	$V_D = 12\text{ V}; I_{GT} = 0.1\text{ A}$	-	1.2	10	mA
$V_T$	On-state voltage	$I_T = 5\text{ A}$	-	1.4	1.70	V
$V_{GT}$	Gate trigger voltage	$V_D = 12\text{ V}; I_T = 0.1\text{ A}$	-	0.7	1.5	V
$I_D$	Off-state leakage current	$V_D = 400\text{ V}; I_T = 0.1\text{ A}; T_j = 125\text{ °C}$	0.25	0.4	-	V
		$V_D = V_{DRM(max)}; T_j = 125\text{ °C}$	-	0.1	0.5	mA

## DYNAMIC CHARACTERISTICS

 $T_j = 25\text{ °C}$  unless otherwise stated

SYMBOL	PARAMETER	CONDITIONS	MIN.	TYP.	MAX.	UNIT
$dV_D/dt$	Critical rate of rise of off-state voltage	$V_{DM} = 67\% V_{DRM(max)}; T_j = 125\text{ °C};$ exponential waveform; $R_{GK} = 1\text{ k}\Omega$	-	5	-	V/ $\mu$ s
$t_{gt}$	Gate controlled turn-on time	$I_{TM} = 6\text{ A}; V_D = V_{DRM(max)}; I_G = 0.1\text{ A};$ $di_G/dt = 5\text{ A}/\mu$ s	-	2	-	$\mu$ s

Triacs  
logic level

BT136 series D

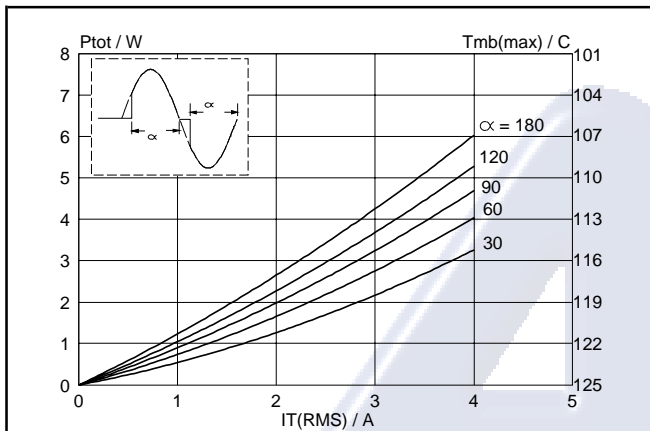

Fig.1. Maximum on-state dissipation,  $P_{tot}$ , versus rms on-state current,  $I_{T(RMS)}$ , where  $\alpha =$  conduction angle.

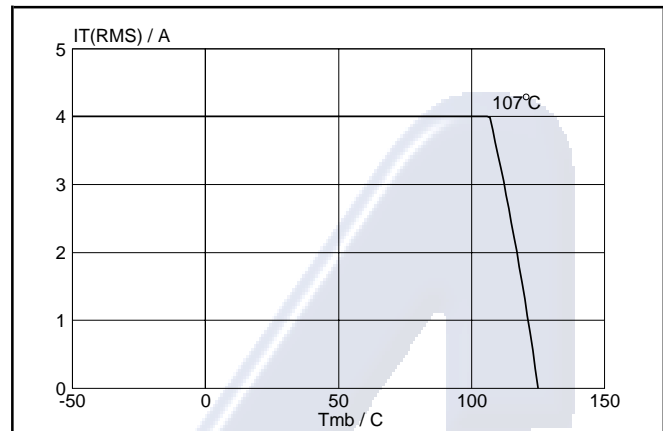

Fig.4. Maximum permissible rms current  $I_{T(RMS)}$ , versus mounting base temperature  $T_{mb}$ .

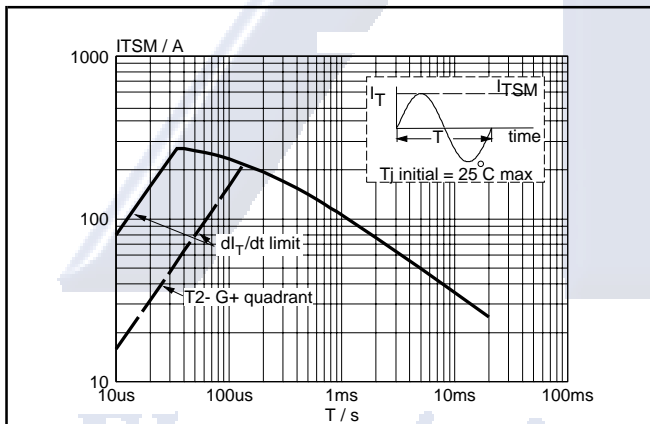

Fig.2. Maximum permissible non-repetitive peak on-state current  $I_{TSM}$ , versus pulse width  $t_p$ , for sinusoidal currents,  $t_p \leq 20\text{ms}$ .

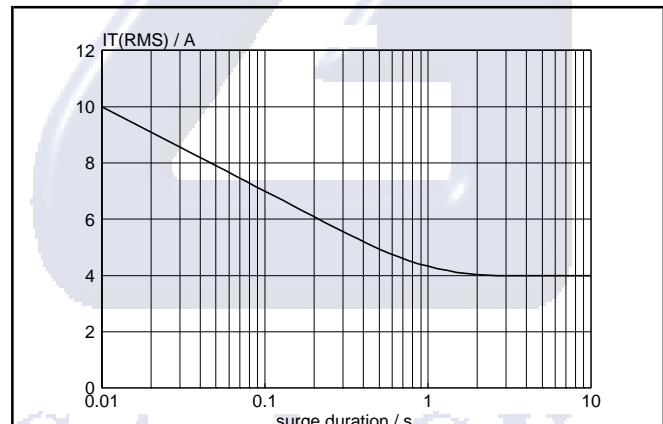

Fig.5. Maximum permissible repetitive rms on-state current  $I_{T(RMS)}$ , versus surge duration, for sinusoidal currents,  $f = 50\text{ Hz}$ ;  $T_{mb} \leq 107^\circ\text{C}$ .

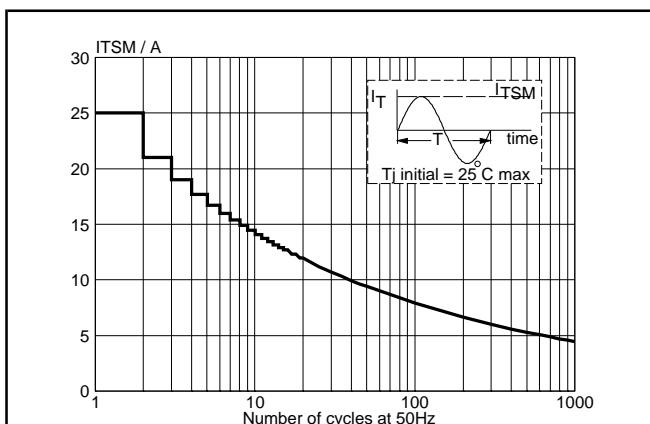

Fig.3. Maximum permissible non-repetitive peak on-state current  $I_{TSM}$ , versus number of cycles, for sinusoidal currents,  $f = 50\text{ Hz}$ .

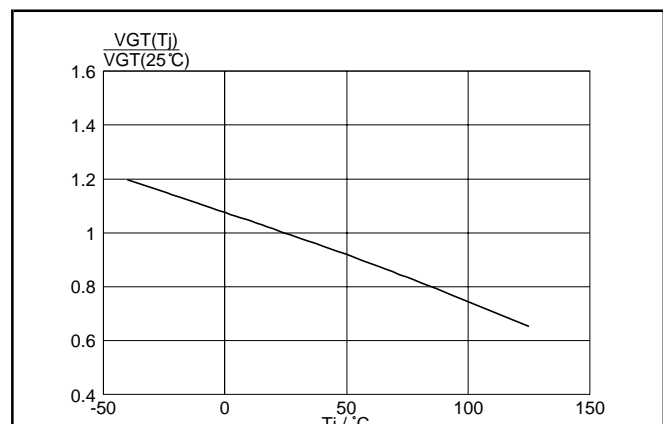
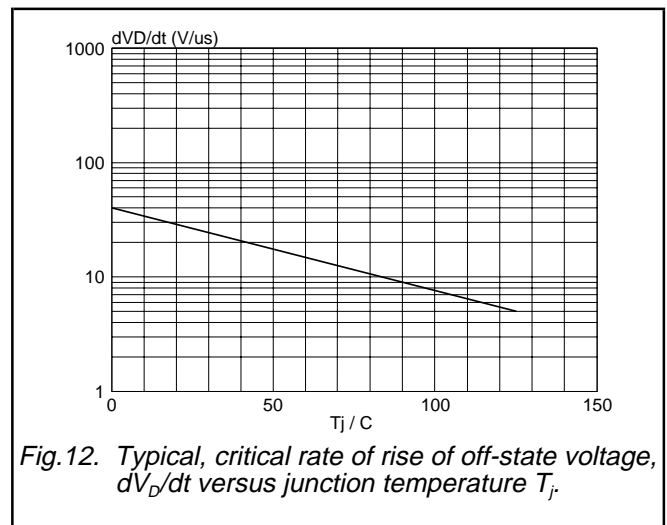
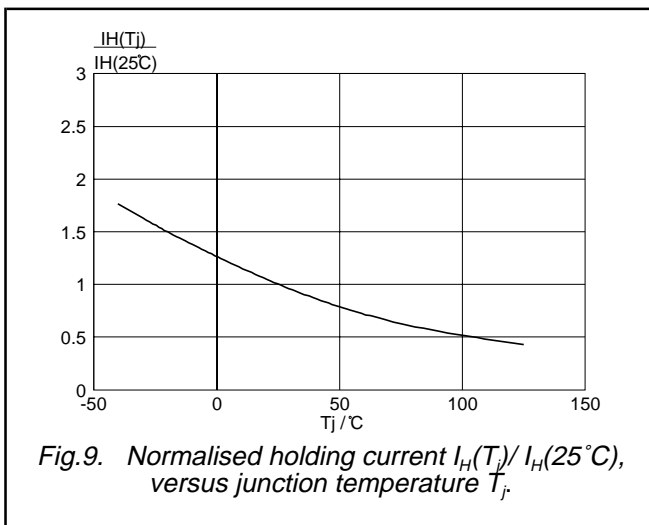
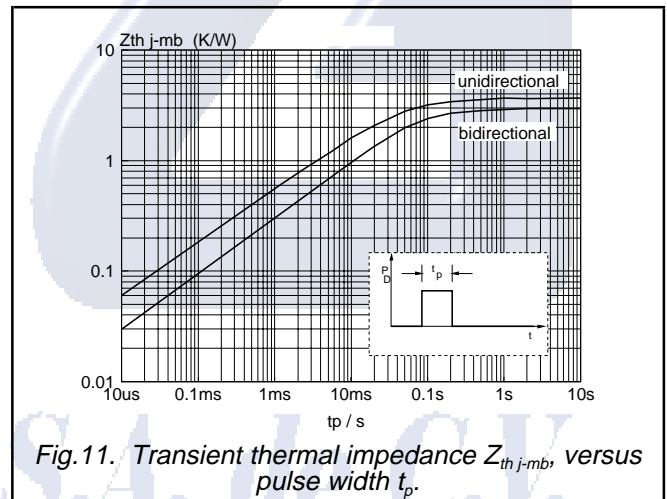
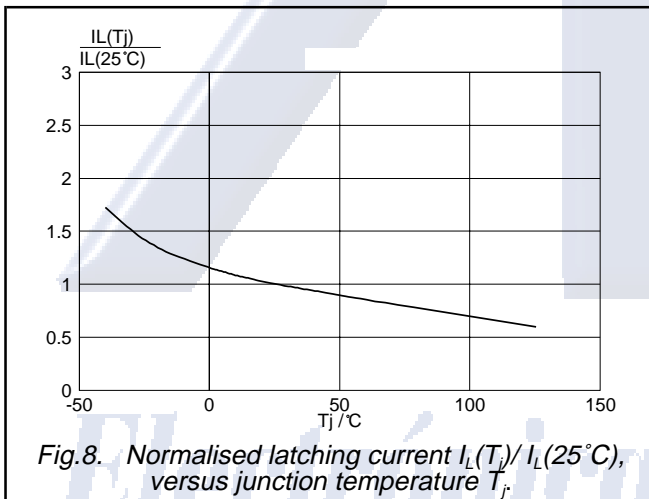
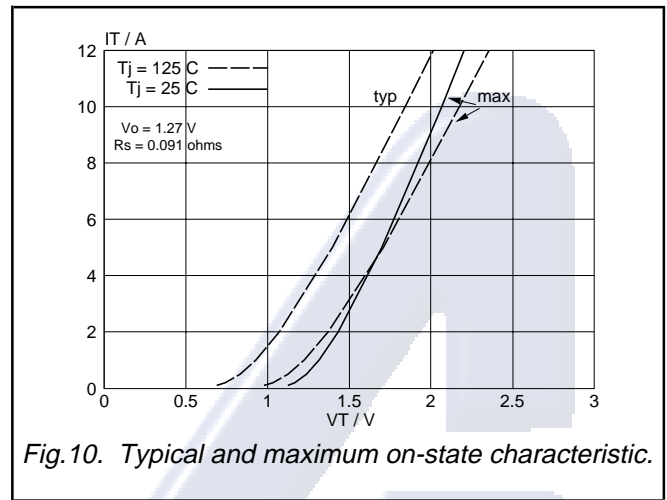
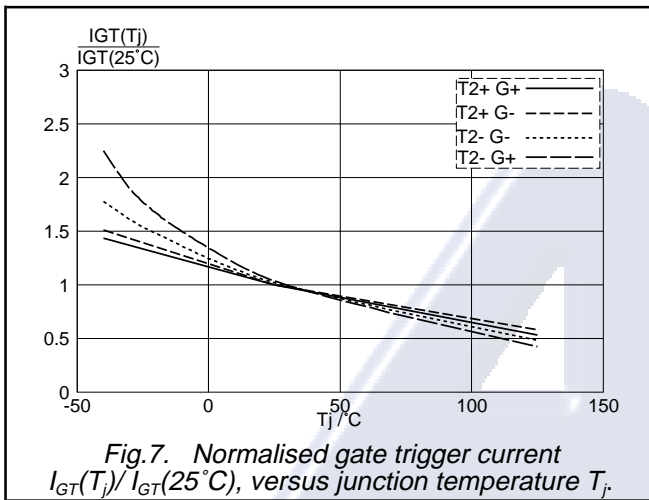

Fig.6. Normalised gate trigger voltage  $V_{GT}(T_j)/V_{GT}(25^\circ\text{C})$ , versus junction temperature  $T_j$ .

Triacs  
logic level

BT136 series D



Triacs  
logic level

BT136 series D

## MECHANICAL DATA

Dimensions in mm

Net Mass: 2 g

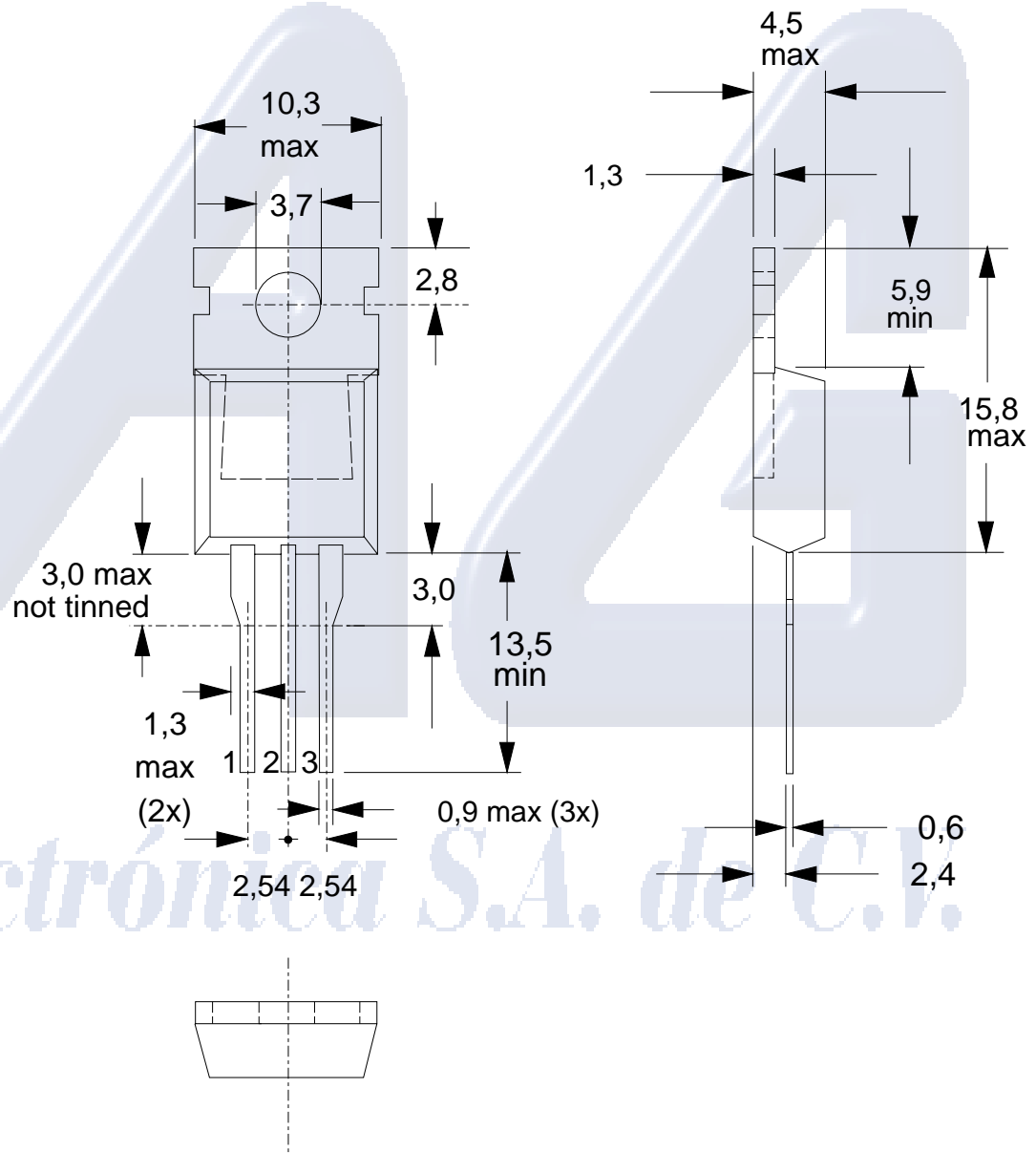

Fig.13. TO220AB; pin 2 connected to mounting base.

### Notes

1. Refer to mounting instructions for TO220 envelopes.
2. Epoxy meets UL94 V0 at 1/8".

## Triacs logic level

BT136 series D

### DEFINITIONS

<b>Data sheet status</b>	
Objective specification	This data sheet contains target or goal specifications for product development.
Preliminary specification	This data sheet contains preliminary data; supplementary data may be published later.
Product specification	This data sheet contains final product specifications.
<b>Limiting values</b>	
Limiting values are given in accordance with the Absolute Maximum Rating System (IEC 134). Stress above one or more of the limiting values may cause permanent damage to the device. These are stress ratings only and operation of the device at these or at any other conditions above those given in the Characteristics sections of this specification is not implied. Exposure to limiting values for extended periods may affect device reliability.	
<b>Application information</b>	
Where application information is given, it is advisory and does not form part of the specification.	
© Philips Electronics N.V. 1997	
All rights are reserved. Reproduction in whole or in part is prohibited without the prior written consent of the copyright owner.	
The information presented in this document does not form part of any quotation or contract, it is believed to be accurate and reliable and may be changed without notice. No liability will be accepted by the publisher for any consequence of its use. Publication thereof does not convey nor imply any license under patent or other industrial or intellectual property rights.	

### LIFE SUPPORT APPLICATIONS

These products are not designed for use in life support appliances, devices or systems where malfunction of these products can be reasonably expected to result in personal injury. Philips customers using or selling these products for use in such applications do so at their own risk and agree to fully indemnify Philips for any damages resulting from such improper use or sale.

*Electrónica S.A. de C.V.*