

Features

- Planar Die Construction
- 200mW Power Dissipation
- Zener Voltages from 2.4V – 39V
- Ultra-Small Surface Mount Package
- **Lead Free/RoHS Compliant (Note 4)**
- **"Green" Device (Notes 1 and 2)**

Mechanical Data

- Case: SOT-323
- Case Material: Molded Plastic, "Green" Molding Compound, Note 2. UL Flammability Classification Rating 94V-0
- Moisture Sensitivity: Level 1 per J-STD-020D
- Terminals: Solderable per MIL-STD-202, Method 208
- Lead Free Plating (Matte Tin Finish annealed over Alloy 42 leadframe).
- Polarity: See Diagram
- Marking Information: See Page 3
- Ordering Information: See Page 3
- Weight: 0.006 grams (approximate)



Top View

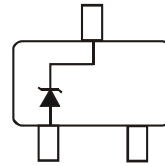

Device Schematic

Maximum Ratings @ $T_A = 25^\circ\text{C}$ unless otherwise specified

Characteristic	Symbol	Value	Unit
Forward Voltage @ $I_F = 10\text{mA}$	V_F	0.9	V

Thermal Characteristics

Characteristic	Symbol	Value	Unit
Power Dissipation (Note 3)	P_D	200	mW
Thermal Resistance, Junction to Ambient Air (Note 3)	$R_{\theta JA}$	625	K/W
Operating and Storage Temperature Range	T_J, T_{STG}	-65 to +125	$^\circ\text{C}$

- Notes:
1. Diodes Inc.'s "Green" policy can be found on our website at http://www.diodes.com/products/lead_free/index.php.
 2. Product manufactured with Date Code 0627 (week 27, 2006) and newer are built with Green Molding Compound. Product manufactured prior to Date Code 0627 are built with Non-Green Molding Compound and may contain Halogens or Sb2O3 Fire Retardants.
 3. Mounted on FR4 PC board with recommended pad layout which can be found on our website at <http://www.diodes.com/datasheets/ap02001.pdf>.
 4. No purposefully added lead.

Electrical Characteristics @T_A = 25°C unless otherwise specified

Type Number	Marking Code	Zener Voltage Range (Note 5)				Maximum Zener Impedance (Note 6)			Maximum Reverse Current (Note 5)		Temperature Coefficient of Zener Voltage @ I _{ZT} = 5mA (mV/°C)	
		V _Z @ I _{ZT}			I _{ZT}	Z _{ZT} @ I _{ZT}	Z _{ZK} @ I _{ZK}	I _{ZK}	I _R	@ V _R	Min	Max
		Nom (V)	Min (V)	Max (V)	mA	Ω	mA	μA	V			
BZX84C2V4W	KRB	2.4	2.2	2.6	5.0	100	600	1.0	50	1.0	-3.5	0
BZX84C2V7W	KRC	2.7	2.5	2.9	5.0	100	600	1.0	20	1.0	-3.5	0
BZX84C3V0W	KRD	3.0	2.8	3.2	5.0	95	600	1.0	20	1.0	-3.5	0
BZX84C3V3W	KRE	3.3	3.1	3.5	5.0	95	600	1.0	5.0	1.0	-3.5	0
BZX84C3V6W	KRF	3.6	3.4	3.8	5.0	90	600	1.0	5.0	1.0	-3.5	0
BZX84C3V9W	KRG	3.9	3.7	4.1	5.0	90	600	1.0	3.0	1.0	-3.5	0
BZX84C4V3W	KRH	4.3	4.0	4.6	5.0	90	600	1.0	3.0	1.0	-3.5	0
BZX84C4V7W	KR1	4.7	4.4	5.0	5.0	80	600	1.0	3.0	2.0	-3.5	0.2
BZX84C5V1W	KR2	5.1	4.8	5.4	5.0	60	500	1.0	2.0	2.0	-2.7	1.2
BZX84C5V6W	KR3	5.6	5.2	6.0	5.0	40	480	1.0	1.0	2.0	-2.0	2.5
BZX84C6V2W	KR4	6.2	5.8	6.6	5.0	10	400	1.0	3.0	4.0	0.4	3.7
BZX84C6V8W	KR5	6.8	6.4	7.2	5.0	15	150	1.0	2.0	4.0	1.2	4.5
BZX84C7V5W	KR6	7.5	7.0	7.9	5.0	15	80	1.0	1.0	5.0	2.5	5.3
BZX84C8V2W	KR7	8.2	7.7	8.7	5.0	15	80	1.0	0.7	5.0	3.2	6.2
BZX84C9V1W	KR8	9.1	8.5	9.6	5.0	15	80	1.0	0.5	6.0	3.8	7.0
BZX84C10W	KR9	10	9.4	10.6	5.0	20	100	1.0	0.2	7.0	4.5	8.0
BZX84C11W	KP1	11	10.4	11.6	5.0	20	150	1.0	0.1	8.0	5.4	9.0
BZX84C12W	KP2	12	11.4	12.7	5.0	25	150	1.0	0.1	8.0	6.0	10.0
BZX84C13W	KP3	13	12.4	14.1	5.0	30	150	1.0	0.1	8.0	7.0	11.0
BZX84C15W	KP4	15	13.8	15.6	5.0	30	170	1.0	0.1	10.5	9.2	13.0
BZX84C16W	KP5	16	15.3	17.1	5.0	40	200	1.0	0.1	11.2	10.4	14.0
BZX84C18W	KP6	18	16.8	19.1	5.0	45	200	1.0	0.1	12.6	12.4	16.0
BZX84C20W	KP7	20	18.8	21.2	5.0	55	225	1.0	0.1	14.0	14.4	18.0
BZX84C22W	KP8	22	20.8	23.3	5.0	55	225	1.0	0.1	15.4	16.4	20.0
BZX84C24W	KP9	24	22.8	25.6	5.0	70	250	1.0	0.1	16.8	18.4	22.0
BZX84C27W	KPA	27	25.1	28.9	2.0	80	250	0.5	0.1	18.9	21.4	25.3
BZX84C30W	KPB	30.0	28.0	32.0	2.0	80	300	0.5	0.1	21.0	24.4	29.4
BZX84C33W	KPC	33.0	31.0	35.0	2.0	80	300	0.5	0.1	23.1	27.4	33.4
BZX84C36W	KPD	36.0	34.0	38.0	2.0	90	325	0.5	0.1	25.2	30.4	37.4
BZX84C39W	KPE	39.0	37.0	41.0	2.0	130	350	0.5	0.1	27.3	33.4	41.2

Notes: 5. Short duration pulse test used to minimize self-heating effect.
6. f = 1KHz.

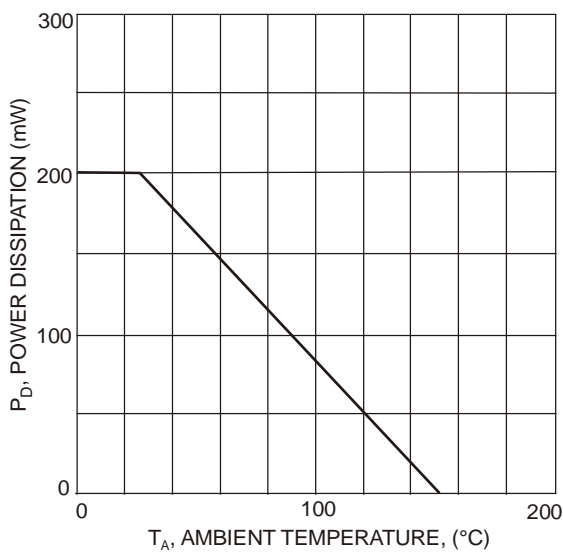

Fig. 1 Power Derating Curve

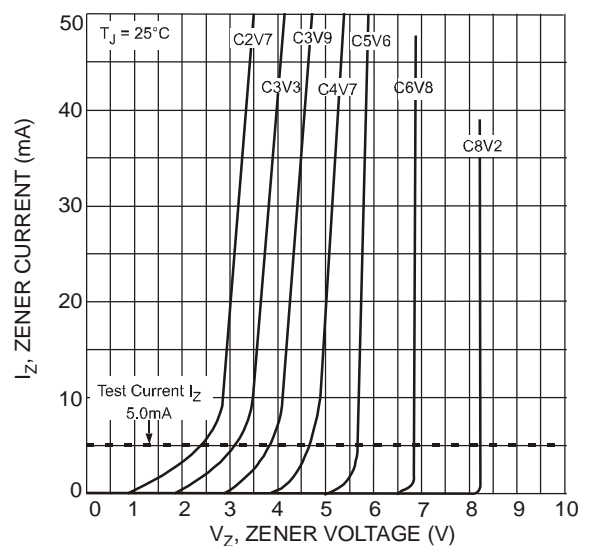

Fig. 2 Typical Zener Breakdown Characteristics

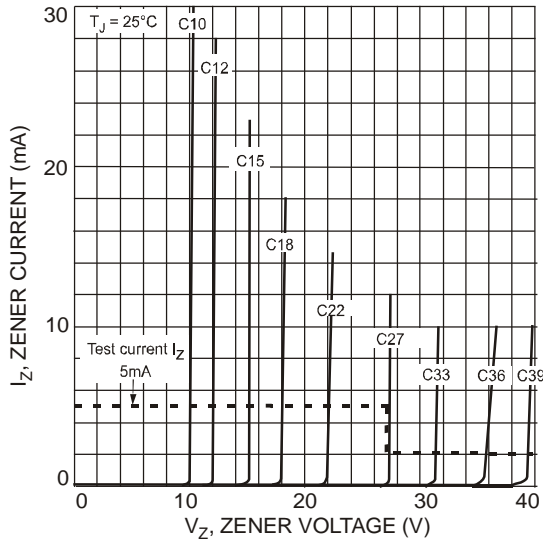

Fig. 3 Typical Zener Breakdown Characteristics

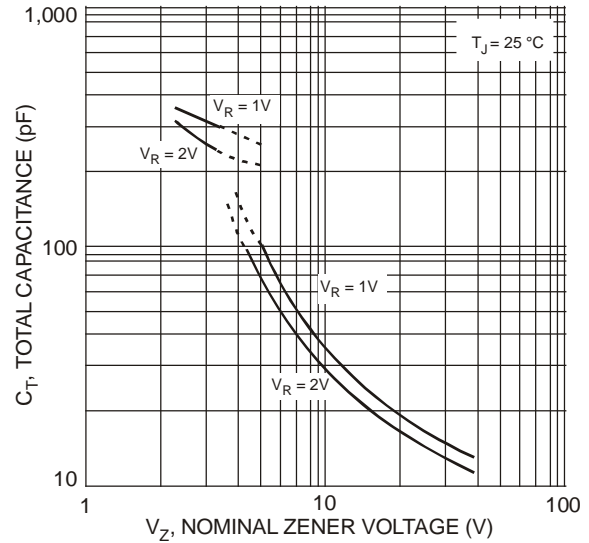

Fig. 4 Typical Total Capacitance vs. Nominal Zener Voltage

Ordering Information (Notes 2 & 7)

Part Number	Case	Packaging
(Type Number)-7-F*	SOT-323	3000/Tape & Reel

* Add "-7-F" to the appropriate type number in Electrical Characteristics Table on Page 2 example: 6.2V Zener = BZX84C6V2W-7-F.

Notes: 7. For packaging details, go to our website at <http://www.diodes.com/datasheets/ap02007.pdf>.

Marking Information

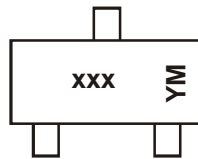

xxx = Product Type Marking Code
(See Electrical Characteristics Table)
YM = Date Code Marking
Y = Year (ex: N = 2002)
M = Month (ex: 9 = September)

Date Code Key

Year	1998	1999	2000	2001	2002	2003	2004	2005	2006	2007	2008	2009	2010	2011	2012
Code	J	K	L	M	N	P	R	S	T	U	V	W	X	Y	Z

Month	Jan	Feb	Mar	Apr	May	Jun	Jul	Aug	Sep	Oct	Nov	Dec
Code	1	2	3	4	5	6	7	8	9	O	N	D

Package Outline Dimensions

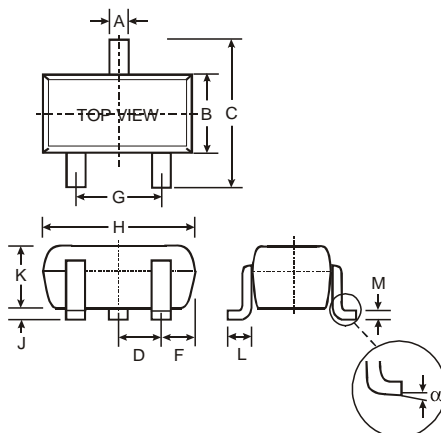

SOT-323		
Dim	Min	Max
A	0.25	0.40
B	1.15	1.35
C	2.00	2.20
D	0.65 Nominal	
F	0.30	0.40
G	1.20	1.40
H	1.80	2.20
J	0.0	0.10
K	0.90	1.00
L	0.25	0.40
M	0.10	0.18
α	0°	8°
All Dimensions in mm		

Suggested Pad Layout



Dimensions	Value (in mm)
Z	2.8
X	0.7
Y	0.9
C	1.9
E	1.0

IMPORTANT NOTICE

Diodes Incorporated and its subsidiaries reserve the right to make modifications, enhancements, improvements, corrections or other changes without further notice to any product herein. Diodes Incorporated does not assume any liability arising out of the application or use of any product described herein; neither does it convey any license under its patent rights, nor the rights of others. The user of products in such applications shall assume all risks of such use and will agree to hold Diodes Incorporated and all the companies whose products are represented on our website, harmless against all damages.

LIFE SUPPORT

Diodes Incorporated products are not authorized for use as critical components in life support devices or systems without the expressed written approval of the President of Diodes Incorporated.