

C3D04060F

Silicon Carbide Schottky Diode

Z-REC[®] RECTIFIER (FULL-PAK)

Features

- 600-Volt Schottky Rectifier
- Zero Reverse Recovery Current
- Zero Forward Recovery Voltage
- High-Frequency Operation
- Temperature-Independent Switching Behavior
- Extremely Fast Switching
- Positive Temperature Coefficient on V_F
- Fully Isolated Case

Benefits

- Replace Bipolar with Unipolar Rectifiers
- Essentially No Switching Losses
- Higher Efficiency
- Reduction of Heat Sink Requirements
- Parallel Devices Without Thermal Runaway

Applications

- Switch Mode Power Supplies (SMPS)
- Boost diodes in PFC or DC/DC stages
- Free Wheeling Diodes in Inverter stages
- AC/DC converters

Maximum Ratings ($T_C = 25^\circ\text{C}$ unless otherwise specified)

Symbol	Parameter	Value	Unit	Test Conditions	Note
V_{RRM}	Repetitive Peak Reverse Voltage	600	V		
V_{DC}	DC Blocking Voltage	600	V		
I_F	Continuous Forward Current	9 6 4	A	$T_C=25^\circ\text{C}$ $T_C=100^\circ\text{C}$ $T_C=135^\circ\text{C}$	Fig. 3
I_{FRM}	Repetitive Peak Forward Surge Current	15 10.5	A	$T_C=25^\circ\text{C}$, $t_p = 10$ ms, Half Sine Wave $T_C=110^\circ\text{C}$, $t_p = 10$ ms, Half Sine Wave	
I_{FSM}	Non-Repetitive Peak Forward Surge Current	19 16.5	A	$T_C=25^\circ\text{C}$, $t_p = 10$ ms, Half Sine Wave $T_C=110^\circ\text{C}$, $t_p = 10$ ms, Half Sine Wave	Fig. 8
$I_{FSM(max)}$	Non-Repetitive Peak Forward Surge Current	220 160	A	$T_C=25^\circ\text{C}$, $t_p = 10$ μs , Pulse $T_C=110^\circ\text{C}$, $t_p = 10$ μs , Pulse	Fig. 8
P_{tot}	Power Dissipation	30.9 13.4	W	$T_C=25^\circ\text{C}$ $T_C=110^\circ\text{C}$	Fig. 4
dV/dt	Diode dV/dt ruggedness	200	V/ns	$V_R=0-600\text{V}$	
$\int i^2 dt$	i^2t value (Per Leg)	1.8 1.3	A ² s	$T_C=25^\circ\text{C}$, $t_p=10$ ms $T_C=110^\circ\text{C}$, $t_p=10$ ms	
T_J, T_{stg}	Operating Junction and Storage Temperature	-55 to +175	$^\circ\text{C}$		
	TO-220 Mounting Torque	1 8.8	Nm lbf-in	M3 Screw 6-32 Screw	

V_{RRM}	=	600 V
$I_F (T_C=135^\circ\text{C})$	=	4 A
Q_c	=	10 nC

Package

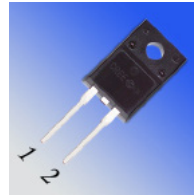

TO-220-F2



Part Number	Package	Marking
C3D04060F	TO-220-F2	C3D04060

Electrical Characteristics

Symbol	Parameter	Typ.	Max.	Unit	Test Conditions	Note
V_F	Forward Voltage	1.5 1.7	1.7 2.4	V	$I_F = 4\text{ A}$ $T_J = 25^\circ\text{C}$ $I_F = 4\text{ A}$ $T_J = 175^\circ\text{C}$	Fig. 1
I_R	Reverse Current	5 10	25 100	μA	$V_R = 650\text{ V}$ $T_J = 25^\circ\text{C}$ $V_R = 650\text{ V}$ $T_J = 175^\circ\text{C}$	Fig. 2
Q_C	Total Capacitive Charge	10		nC	$V_R = 400\text{ V}$, $I_F = 4\text{ A}$ $di/dt = 500\text{ A}/\mu\text{s}$ $T_J = 25^\circ\text{C}$	Fig. 5
C	Total Capacitance	231 18.5 15		pF	$V_R = 0\text{ V}$, $T_J = 25^\circ\text{C}$, $f = 1\text{ MHz}$ $V_R = 200\text{ V}$, $T_J = 25^\circ\text{C}$, $f = 1\text{ MHz}$ $V_R = 400\text{ V}$, $T_J = 25^\circ\text{C}$, $f = 1\text{ MHz}$	Fig. 6
E_C	Capacitance Stored Energy	1.4		μJ	$V_R = 400\text{ V}$	Fig. 7

Note: This is a majority carrier diode, so there is no reverse recovery charge.

Thermal Characteristics

Symbol	Parameter	Typ.	Unit	Note
$R_{\theta JC}$	Thermal Resistance from Junction to Case	4.85	$^\circ\text{C}/\text{W}$	Fig. 9

Typical Performance

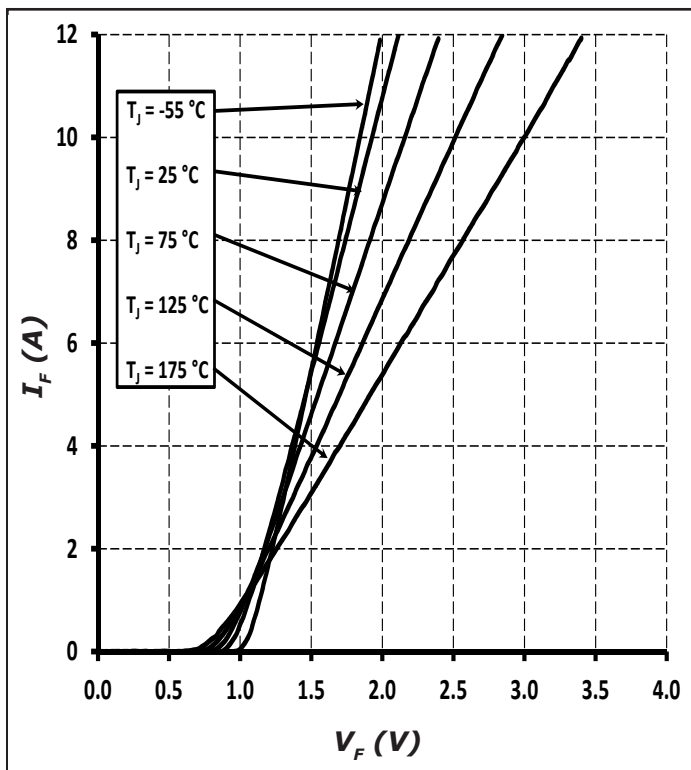

Figure 1. Forward Characteristics

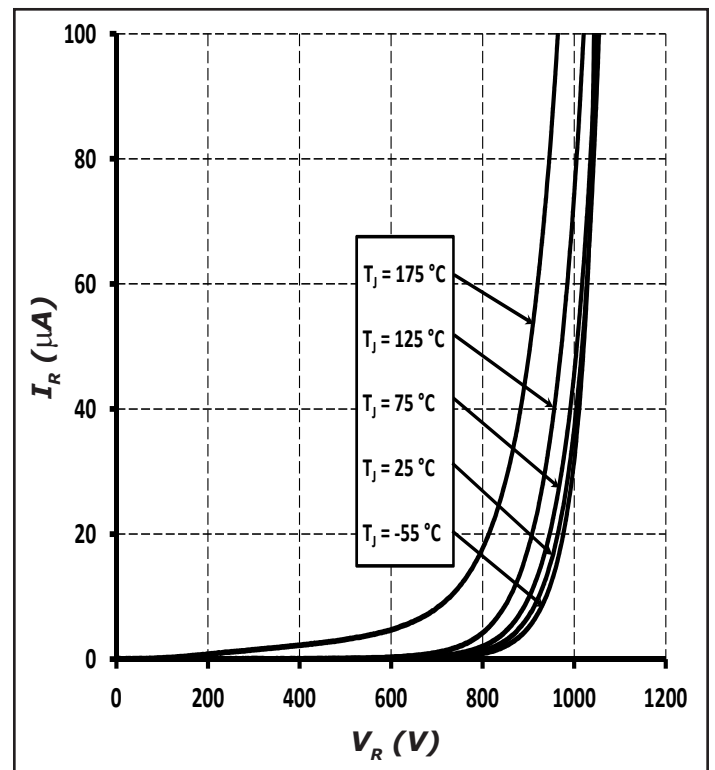

Figure 2. Reverse Characteristics

Typical Performance

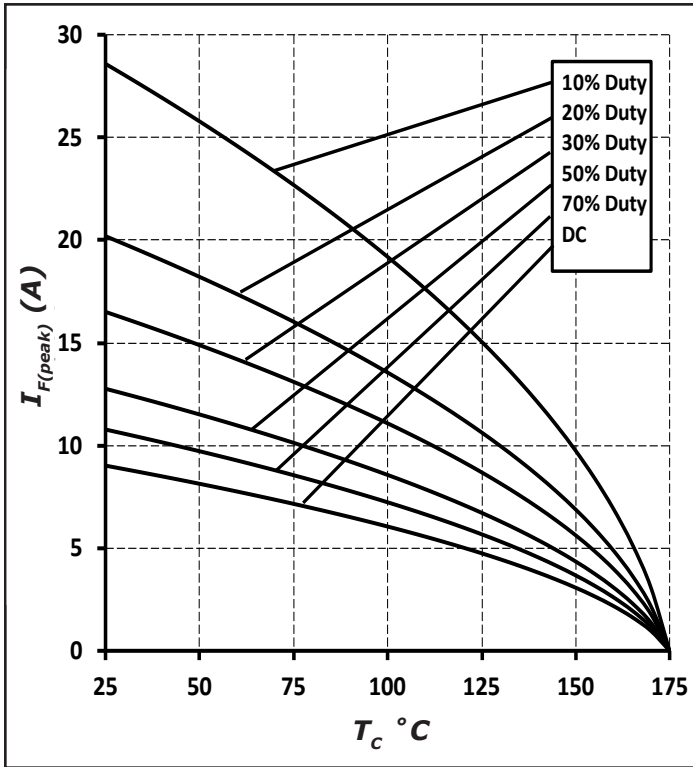

Figure 3. Current Derating

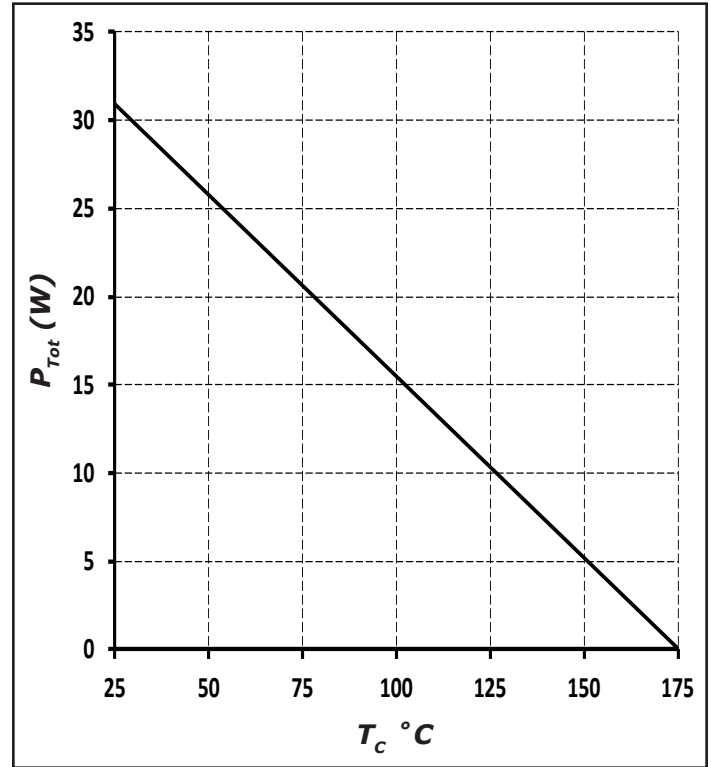

Figure 4. Power Derating

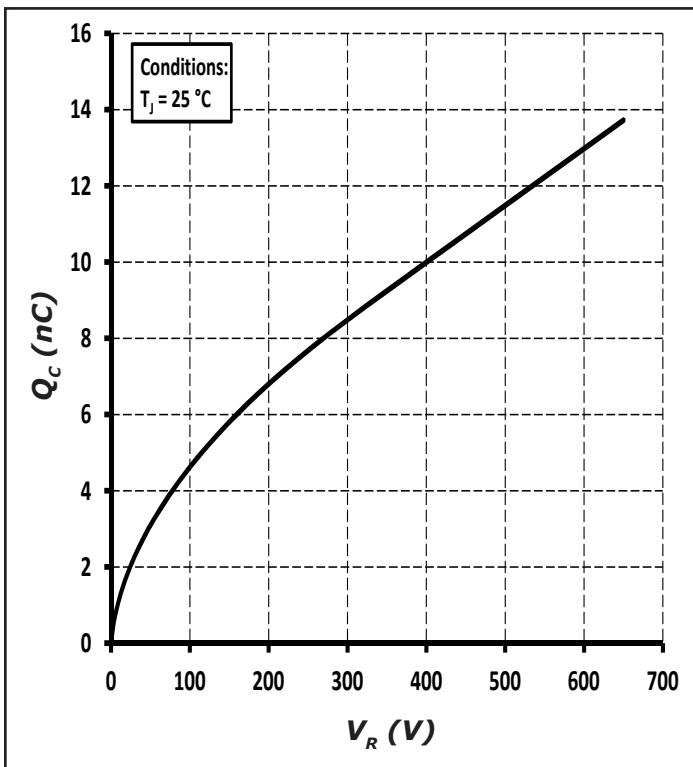

Figure 5. Total Capacitance Charge vs. Reverse Voltage

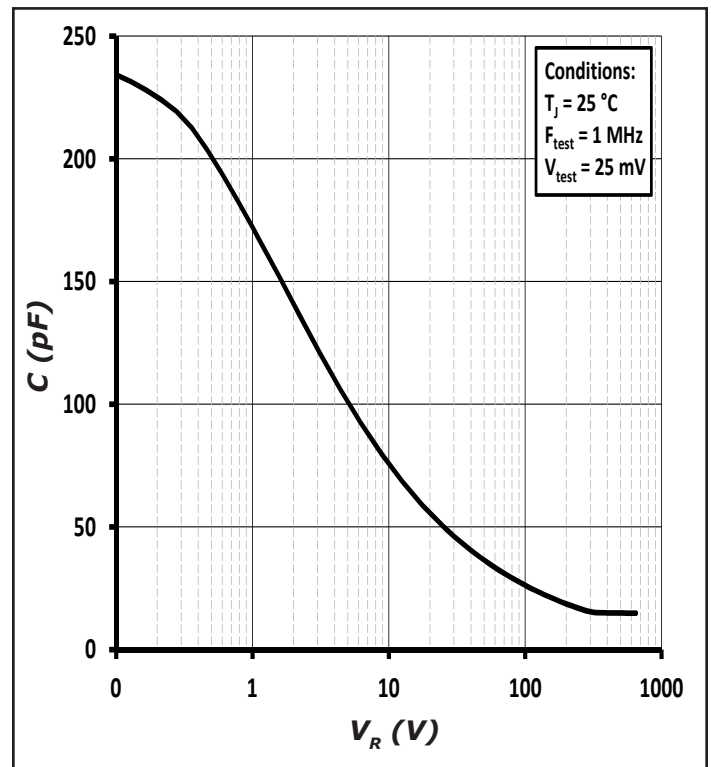

Figure 6. Capacitance vs. Reverse Voltage

Typical Performance

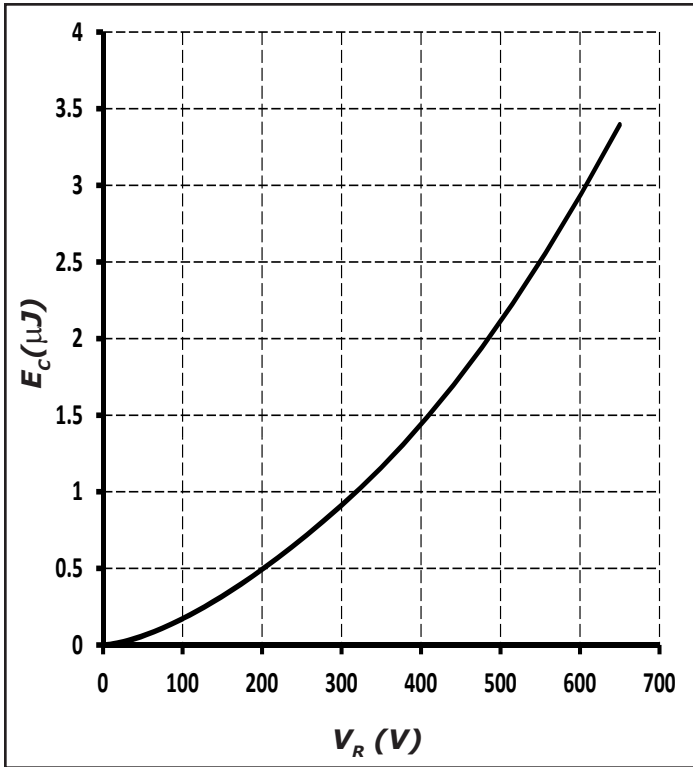

Figure 7. Capacitance Stored Energy

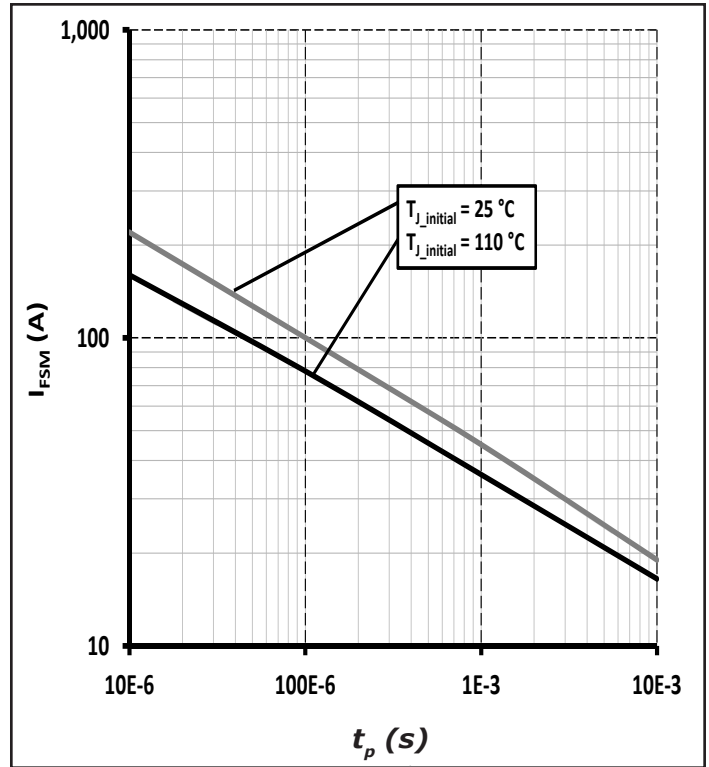

Figure 8. Non-repetitive peak forward surge current versus pulse duration (sinusoidal waveform)

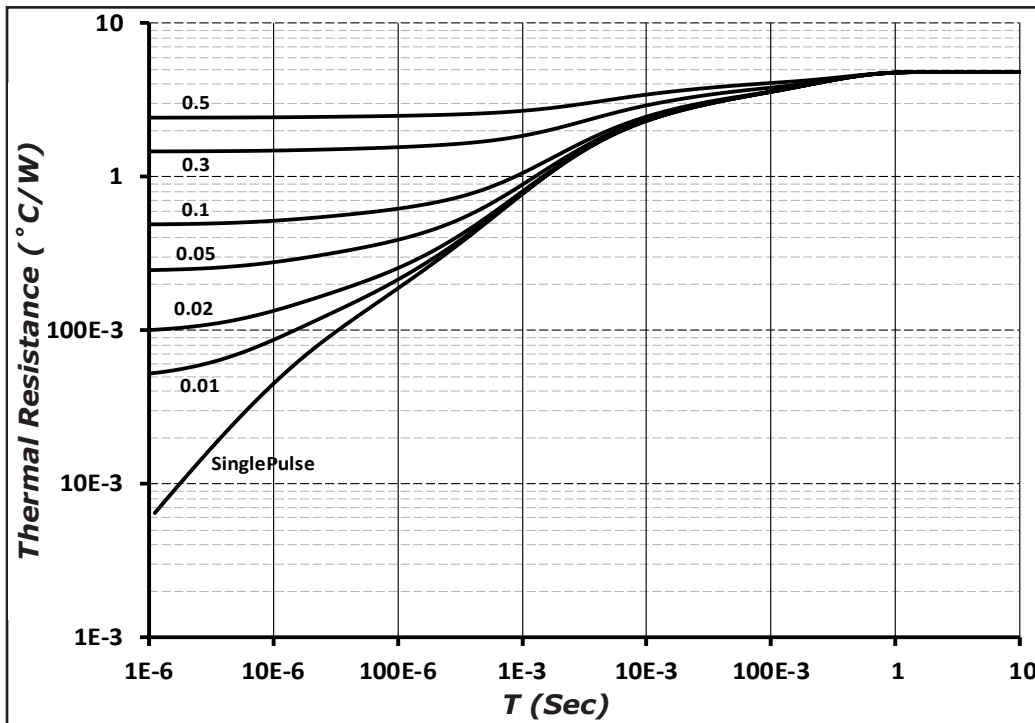
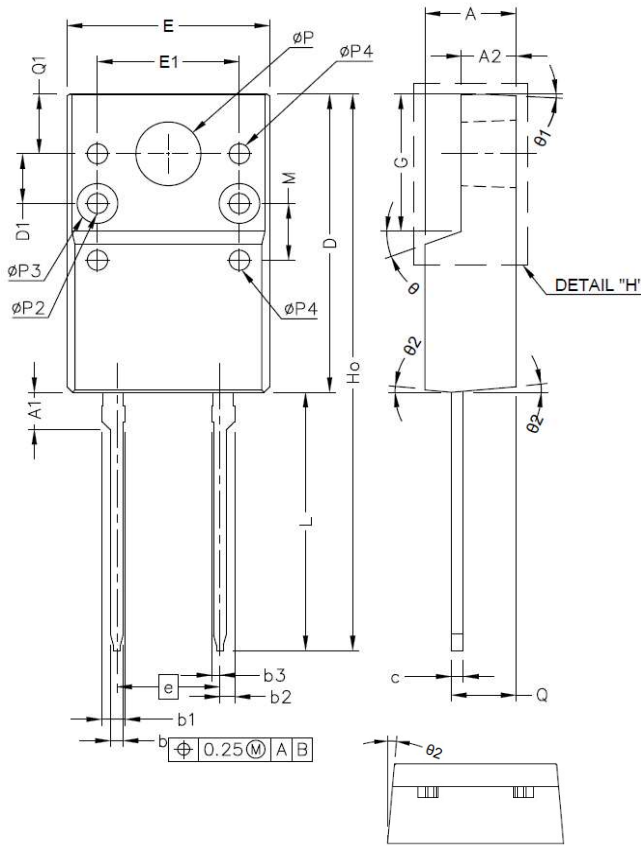

Figure 9. Transient Thermal Impedance

Package Dimensions

Package TO-220-F2



SYMBOL	MIN (mm)	MAX (mm)
A	4.30	4.93
A1	1.80	3.90
A2	2.34	2.90
b	0.40	0.91
b1	1.00	1.40
b2	0.56	0.93
b3	0.24	0.55
C	0.40	0.80
D	14.70	16.07
D1	2.50 TYP	
D2	2.66 TYP	
e	4.83	5.33
E	9.70	10.36
E1	7.00 TYP	
G	6.50	7.10
Ho	28 TYP	
L	12.10	13.50
L1	0.50	
M	2.86 TYP	
ϕP	2.98	3.40
Q	3.10	3.30
Q1	2.70	3.50
θ	20° TYP	
θ_1	3° TYP	
θ_2	5° TYP	

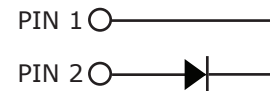

Recommended Solder Pad Layout

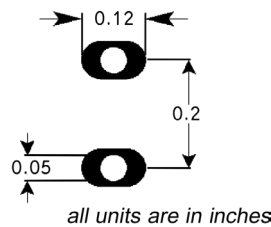

TO-220-2

Part Number	Package	Marking
C3D04060F	TO-220-F2	C3D04060

Note: Recommended soldering profiles can be found in the applications note here: http://www.cree.com/power_app_notes/soldering



Notes

- **RoHS Compliance**

The levels of RoHS restricted materials in this product are below the maximum concentration values (also referred to as the threshold limits) permitted for such substances, or are used in an exempted application, in accordance with EU Directive 2011/65/EC (RoHS2), as implemented January 2, 2013. RoHS Declarations for this product can be obtained from your Wolfspeed representative or from the Product Ecology section of our website at <http://www.wolfspeed.com/Power/Tools-and-Support/Product-Ecology>.

- **REACH Compliance**

REACH substances of high concern (SVHCs) information is available for this product. Since the European Chemical Agency (ECHA) has published notice of their intent to frequently revise the SVHC listing for the foreseeable future, please contact a Cree representative to insure you get the most up-to-date REACH SVHC Declaration. REACH banned substance information (REACH Article 67) is also available upon request.

- This product has not been designed or tested for use in, and is not intended for use in, applications implanted into the human body nor in applications in which failure of the product could lead to death, personal injury or property damage, including but not limited to equipment used in the operation of nuclear facilities, life-support machines, cardiac defibrillators or similar emergency medical equipment, aircraft navigation or communication or control systems, or air traffic control systems.

Related Links

- Cree SiC Schottky diode portfolio: <http://www.wolfspeed.com/Power/Products#SiCSchottkyDiodes>
- Schottky diode Spice models: <http://www.wolfspeed.com/power/tools-and-support/DIODE-model-request2>
- SiC MOSFET and diode reference designs: <http://go.pardot.com/l/101562/2015-07-31/349i>