

CZRU52C2-HF Thru CZRU52C39-HF

Voltage 2 to 39 Volts
 Power 150 mWatts
 RoHS Device
 Halogen Free



Features

- 150mW Power Dissipation.
- High Voltages from 2 ~ 39 V.
- Designed for mounting on small surface.
- Extremely thin/leadless package.
- Pb free product.

Mechanical data

- Case: 0603/SOD-523F Standard package Molded plastic.
- Terminals: Gold plated, solderable per MIL-STD-750,method 2026.
- Polarity: Indicated by cathode band.
- Weight: 0.003 gram(approx.).

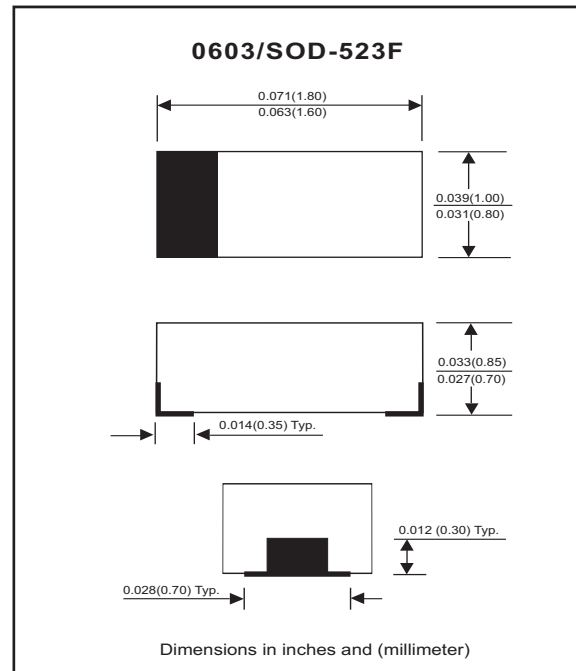

Maximum Rating AND Electrical Characteristics

Parameter	Symbol	Value	Unit
Maximum Forward Voltage Drop at $I_F = 10 \text{ mA}$	V_F	0.9	V
Maximum Power Dissipation at 25 C°	P_D	150	mW
Forward current , surge peak 8.3 ms single half sine-wave superimposed on rate load(JEDEC method)	I_{FSM}	2.0	A
Peak ESD voltage capability (IEC 61000-4-2)	V_{PV}	8	kV
Operating Junction and Storage Temperature Range	T_J	-55 to +125	$^\circ\text{C}$

Electrical Characteristics(Ta = 25C) °

Part Number	Marking Code	Zener Voltage			Operating resistance		Rising operating Resistance		Reverse current	
		Vz(V)			ZZT(Ohm)		ZZK(Ohm)		IR(uA)	
		Min	Max	Iz(mA)	Max	Iz(mA)	Max	Iz(mA)	Max	VR(V)
CZR52C2-HF	Z0	1.90	2.10	5	100	5	600	1	100	1
CZR52C2V2-HF	Z1	2.09	2.31	5	100	5	600	1	100	1
CZR52C2V4-HF	Z2	2.28	2.52	5	85	5	600	1	100	1
CZR52C2V7-HF	Z3	2.57	2.84	5	83	5	500	1	75	1
CZR52C3-HF	Z4	2.85	3.15	5	95	5	500	1	50	1
CZR52C3V3-HF	Z5	3.14	3.47	5	95	5	500	1	25	1
CZR52C3V6-HF	Z6	3.42	3.78	5	95	5	500	1	15	1
CZR52C3V9-HF	Z7	3.71	4.10	5	95	5	500	1	10	1
CZR52C4V3-HF	Z8	4.09	4.52	5	95	5	500	1	5	1
CZR52C4V7-HF	Z9	4.47	4.94	5	78	5	500	1	5	2
CZR52C5V1-HF	ZA	4.85	5.36	5	60	5	480	1	0.1	0.8
CZR52C5V6-HF	ZB	5.32	5.88	5	40	5	400	1	0.1	1
CZR52C6V2-HF	ZC	5.89	6.51	5	10	5	200	1	0.1	2
CZR52C6V8-HF	ZE	6.46	7.14	5	8	5	150	1	0.1	3
CZR52C7V5-HF	ZF	7.13	7.88	5	7	5	50	1	0.1	5
CZR52C8V2-HF	ZG	7.79	8.61	5	7	5	50	1	0.1	6
CZR52C9V1-HF	ZH	8.65	9.56	5	10	5	50	1	0.1	7
CZR52C10-HF	ZJ	9.50	10.50	5	15	5	70	1	0.1	7.5
CZR52C11-HF	ZK	10.45	11.55	5	20	5	70	1	0.1	8.5
CZR52C12-HF	ZM	11.40	12.60	5	20	5	90	1	0.1	9
CZR52C13-HF	ZN	12.35	13.65	5	25	5	110	1	0.1	10
CZR52C15-HF	ZP	14.25	15.75	5	30	5	110	1	0.1	11
CZR52C16-HF	ZQ	15.20	16.80	5	40	5	170	1	0.1	12
CZR52C18-HF	ZR	17.10	18.90	5	50	5	170	1	0.1	14
CZR52C20-HF	ZS	19.00	21.00	5	50	5	220	1	0.1	15
CZR52C22-HF	ZT	20.90	23.10	5	55	5	220	1	0.1	17
CZR52C24-HF	ZU	22.80	25.20	5	80	5	220	1	0.1	18
CZR52C27-HF	ZV	25.65	28.35	5	80	5	250	1	0.1	20
CZR52C30-HF	ZW	28.50	31.50	5	80	5	250	1	0.1	23
CZR52C33-HF	ZX	31.35	34.65	5	80	5	250	1	0.1	25
CZR52C36-HF	ZY	34.20	37.80	5	90	5	250	1	0.1	27
CZR52C39-HF	ZZ	37.05	40.95	5	90	5	300	1	0.1	29

RATING AND CHARACTERISTIC CURVES (CZRU52C2-HF Thru CZRU52C39-HF)

Fig.1 TEMPERATURE COEFFICIENTS

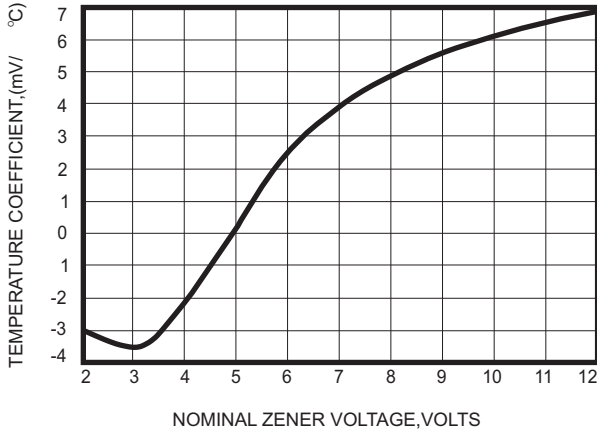

Fig.2 TEMPERATURE COEFFICIENTS

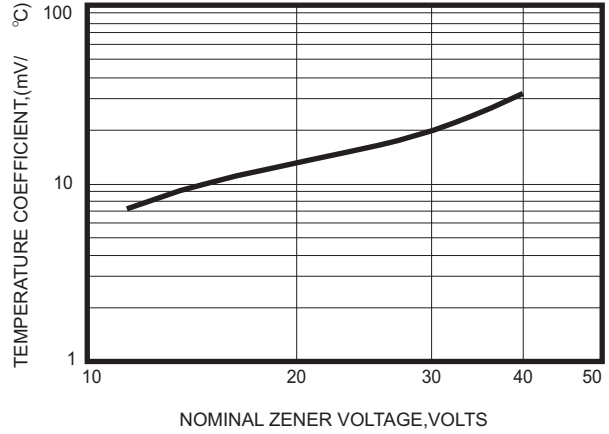

Fig.3 EFFECT OF ZENER VOLTAGE ON ZENER IMPEDANCE

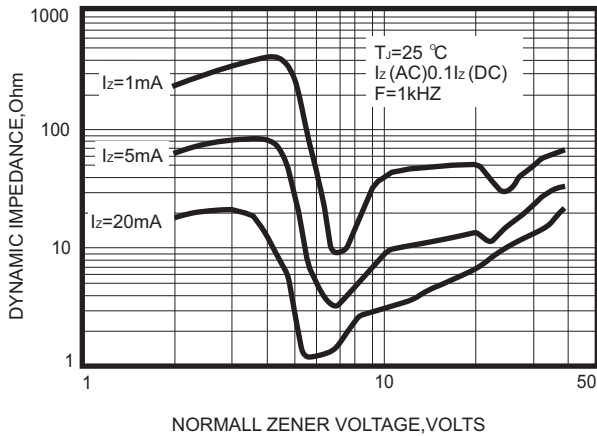

Fig.4 TYPICAL FORWARD VOLTAGE

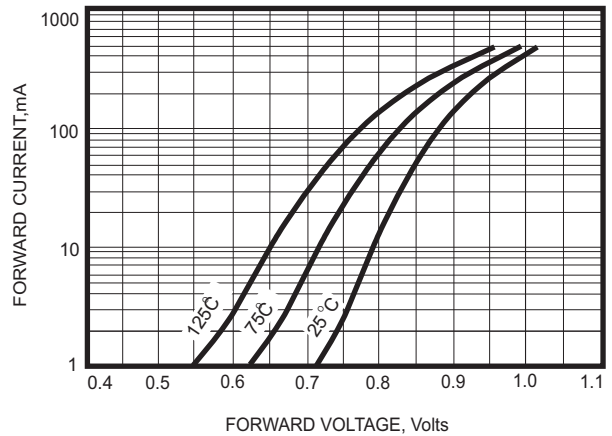

Fig.5 TYPICAL LEAKAGE CURRENT

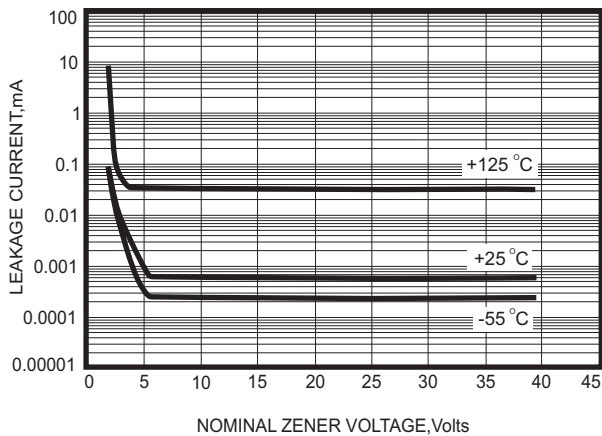
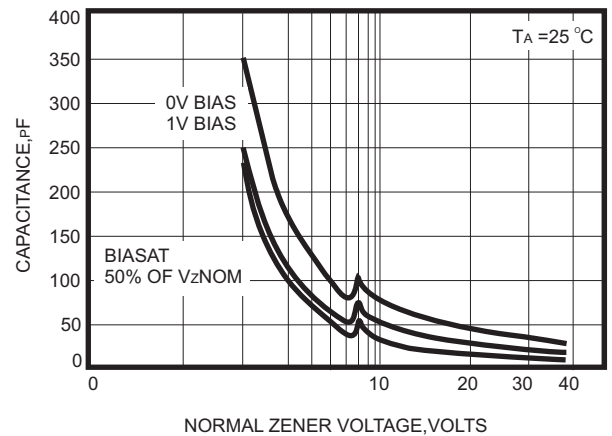

Fig.6 TYPICAL CAPACITANCE



RATING AND CHARACTERISTIC CURVES (CZRU52C2-HF Thru CZRU52C39-HF)

Fig.7 ZENER VOLTAGE VERSUS ZENER CURRENT

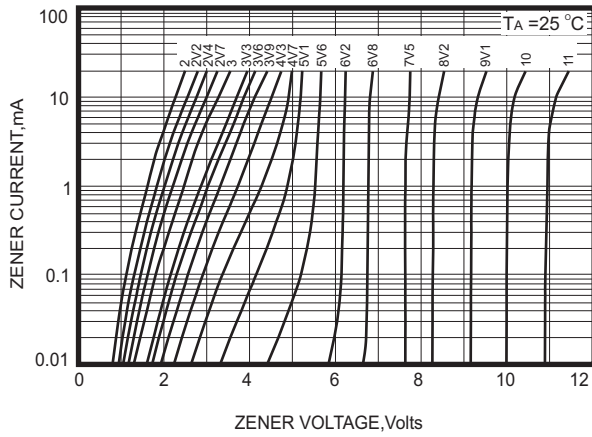

Fig.8 ZENER VOLTAGE VERSUS ZENER CURRENT

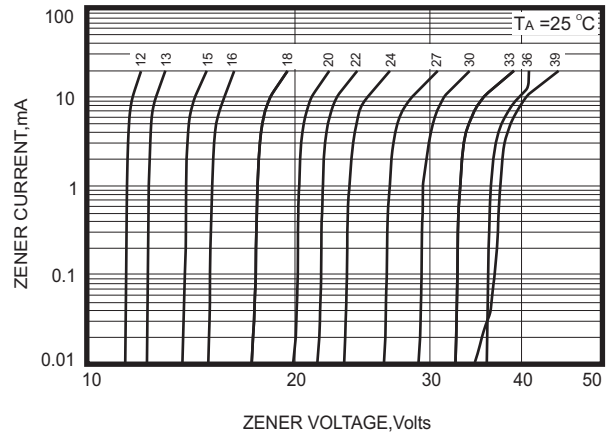
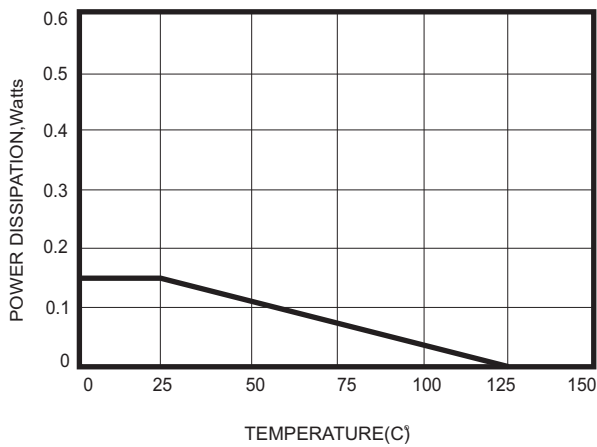
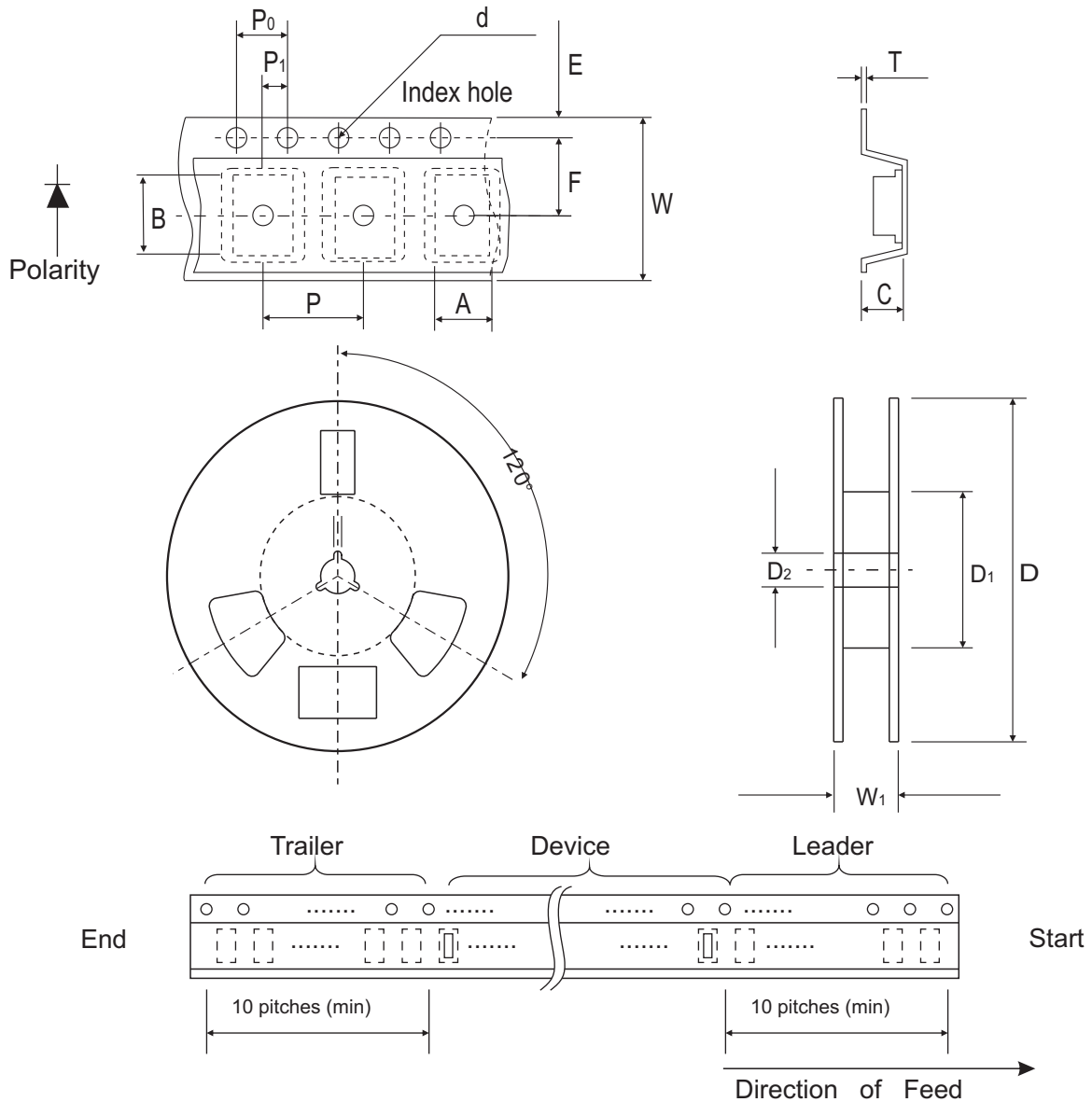

Fig.9 STEADY STATE POWER DERATING



Reel Taping Specification



0603 (SOD-523F)	SYMBOL	A	B	C	d	D	D ₁	D ₂
	(mm)	1.00 ± 0.10	1.85 ± 0.10	1.00 ± 0.10	1.55 ± 0.05	178 ± 1	60.0 MIN.	13.0 ± 0.20
	(inch)	0.039 ± 0.004	0.073 ± 0.004	0.039 ± 0.004	0.061 ± 0.002	7.008 ± 0.04	2.362 MIN.	0.512 ± 0.008

0603 (SOD-523F)	SYMBOL	E	F	P	P ₀	P ₁	T	W	W ₁
	(mm)	1.75 ± 0.10	3.50 ± 0.05	4.00 ± 0.10	4.00 ± 0.10	2.00 ± 0.05	0.23 ± 0.05	8.00 ± 0.20	13.5 MAX.
	(inch)	0.069 ± 0.004	0.138 ± 0.002	0.157 ± 0.004	0.157 ± 0.004	0.079 ± 0.004	0.009 ± 0.002	0.315 ± 0.008	0.531 MAX.

Suggested PAD Layout

SIZE	0603/SOD-523F	
	(mm)	(inch)
A	1.70	0.067
B	0.60	0.024
C	0.80	0.031
D	2.30	0.091
E	1.10	0.043

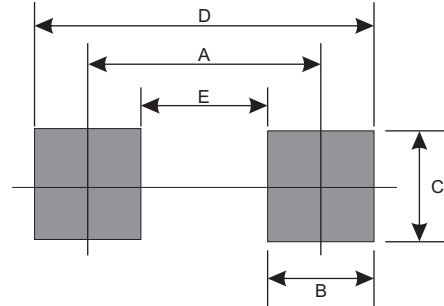

Standard Package

Case Type	Qty per Reel	Reel Size
	(Pcs)	(inch)
0603/SOD-523F	4000	7