

HA17324/A Series

Quad Operational Amplifier

HITACHI

ADE-204-031 (Z)

1st Edition

Apr. 2000

Description

HA17324 series and HA17324A series are quad operational amplifier that provide high gain and internal phase compensation, with single power supply. They can be widely used to control equipments.

Features

- Wide range of supply voltage, and single power supply used
- Internal phase compensation
- Wide range of common mode voltage, and possible to operate with an input about 0V

Features only for "A" series

- Low electro-magnetic interference level

Measurement Condition

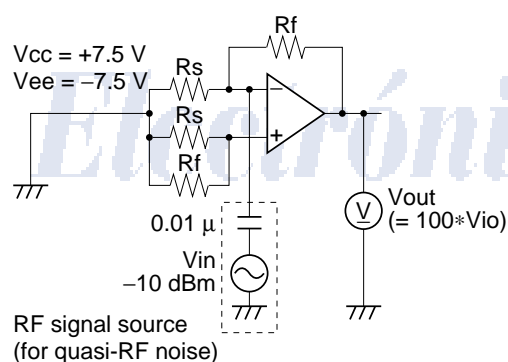

Output Offset Voltage vs. Input Interference

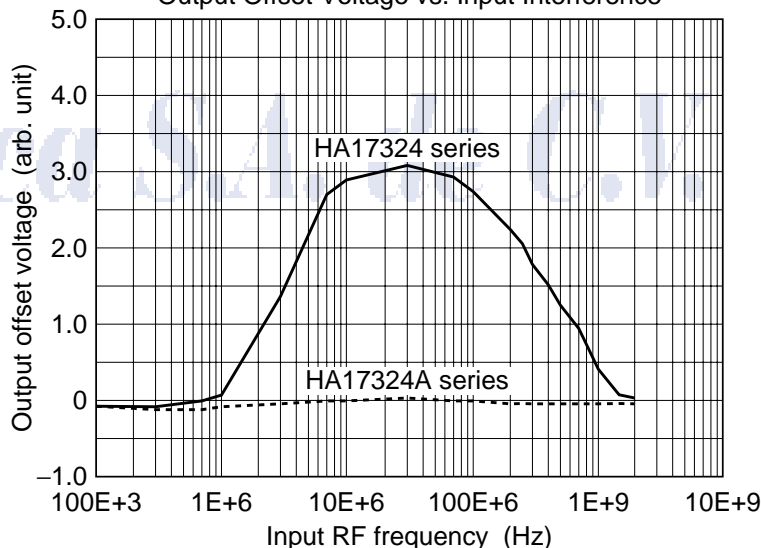

Notice: The example of an applied circuit or combination with other equipment shown herein indicates characteristics and performance of semiconductor -applied products.

The company shall assume no responsibility for any problem involving a patent caused when applying the descriptions in the example.

HA17324/A Series

Ordering Information

HA17324 Series

Type No.	Application	Package
HA17324P	Industrial use	DP-14
HA17324FP		FP-14DA
HA17324	Commercial use	DP-14
HA17324F		FP-14DA

HA17324A Series

Type No.	Application	Package
HA17324AP	Industrial use	DP-14
HA17324ARP		FP-14DN
HA17324AFP		FP-14DA

Electrónica S.A. de C.V.

HITACHI

HA17324/A Series

Pin Arrangement

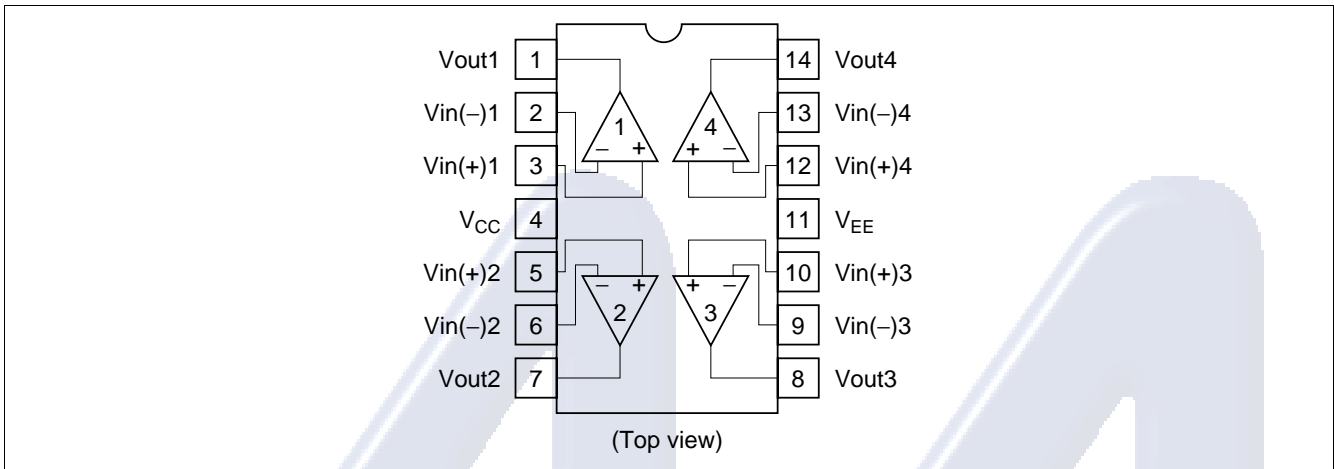

Circuit Schematic (1/4)

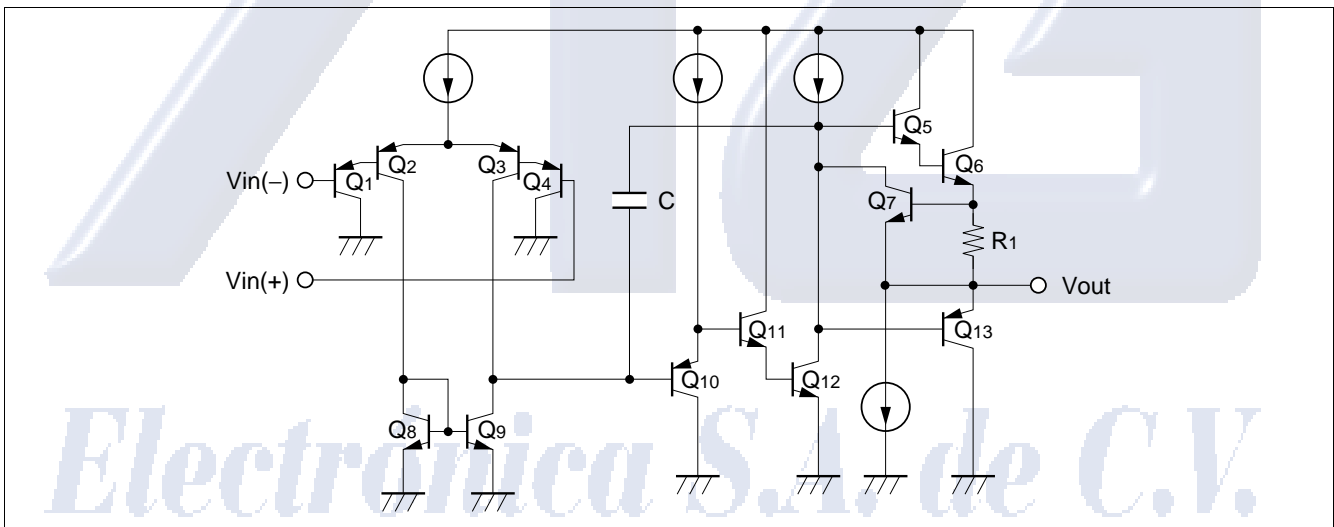

HITACHI

HA17324/A Series

Absolute Maximum Ratings (Ta = 25°C)

Item	Symbol	Ratings		Unit
		HA17324/P/AP	HA17324F/FP/ARP/AFP	
Supply voltage	V_{CC}	32	32	V
Sink current	I_{sink}	50	50	mA
Power dissipation	P_T	625 * ¹	625 * ²	mW
Common mode input voltage	V_{CM}	-0.3 to V_{CC}	-0.3 to V_{CC}	V
Differential input voltage	V_{in} (diff)	$\pm V_{CC}$	$\pm V_{CC}$	V
Operating temperature	T_{opr}	-20 to +75	-20 to +75	°C
Storage temperature	T_{stg}	-55 to +125	-55 to +125	°C

Notes: 1. This is the allowable values up to Ta = 50°C. Derate by 8.3 mW/°C.

2. $T_{jmax} = \theta_{j-a} \cdot P_{c,max} + T_a$ (θ_{j-a} ; Thermal resistor between junction and ambient at set board use).

The wiring density and the material of the set board must be chosen for thermal conductance of efficacy board.

And $P_{c,max}$ cannot be over the value of P_T .

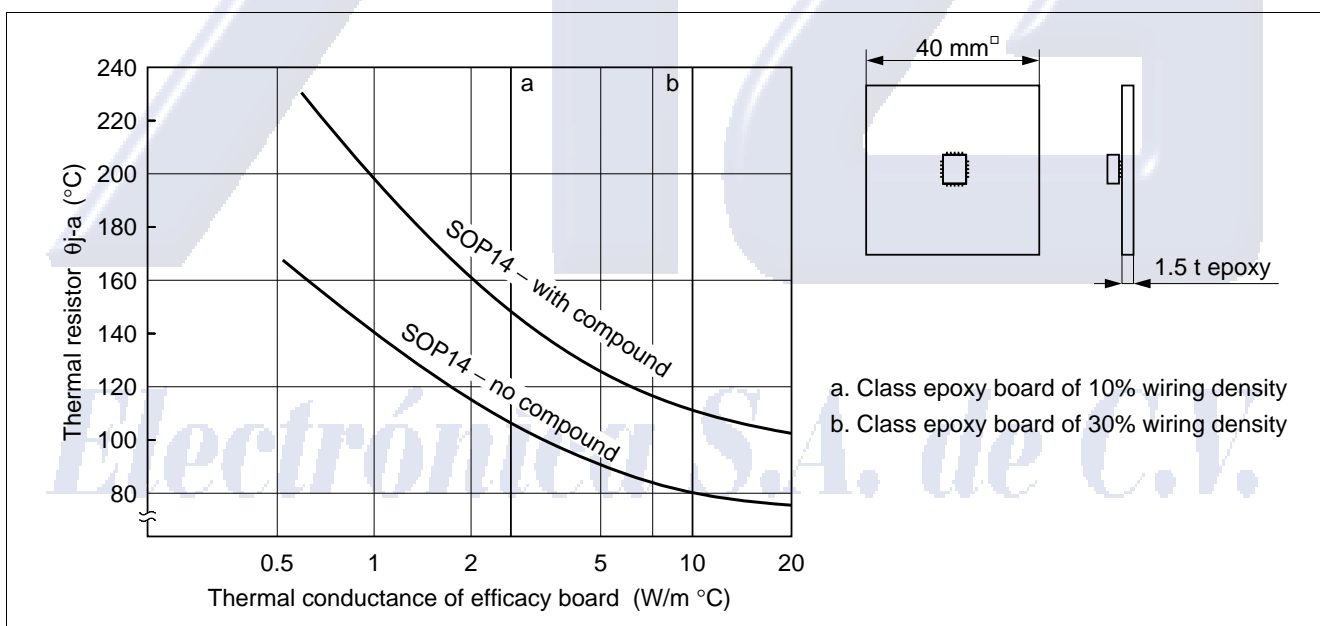

HITACHI

HA17324/A Series**Electrical Characteristics** ($V_{CC} = +15\text{ V}$, $T_a = 25^\circ\text{C}$)

Item	Symbol	Min	Typ	Max	Unit	Test Conditions
Input offset voltage	V_{IO}	—	2	7	mV	$V_{CM} = 7.5\text{ V}$, $R_S = 50\ \Omega$, $R_f = 50\text{ k}\Omega$
Input offset current	I_{IO}	—	5	50	nA	$V_{CM} = 7.5\text{ V}$, $I_{IO} = I_{I(-)} - I_{I(+)} $
Input bias current	I_{IB}	—	30	500	nA	$V_{CM} = 7.5\text{ V}$
Power source rejection ratio	PSRR	—	93	—	dB	$f = 100\text{ Hz}$, $R_S = 1\text{ k}\Omega$, $R_j = 100\text{ k}\Omega$
Voltage gain	A_{VD}	75	90	—	dB	$R_S = 1\text{ k}\Omega$, $R_f = 100\text{ k}\Omega$, $R_L = \infty$
Common mode rejection ratio	CMR	—	80	—	dB	$R_S = 50\ \Omega$, $R_f = 5\text{ k}\Omega$
Common mode input voltage range	V_{CM}	-0.3	—	13.5	V	$R_S = 1\text{ k}\Omega$, $R_f = 100\text{ k}\Omega$, $f = 100\text{ Hz}$
Maximum output voltage	V_{op-p}	—	13.6	—	V	$f = 100\text{ Hz}$, $R_S = 1\text{ k}\Omega$, $R_f = 100\text{ k}\Omega$, $R_L = 20\text{ k}\Omega$
Output source current	$I_{osource}$	20	40	—	mA	$V_{IN}^+ = 1\text{ V}$, $V_{IN}^- = 0\text{ V}$, $V_{OH} = 10\text{ V}$
Output sink current	I_{osink}	10	20	—	mA	$V_{IN} = 0\text{ V}$, $V_{IN} = 1\text{ V}$, $V_{OL} = 2.5\text{ V}$
Supply current	I_{CC}	—	0.8	2	mA	$V_{IN} = \text{GND}$, $R_L = \infty$
Slew rate	SR	—	0.19	—	V/ μs	$f = 1.5\text{ kHz}$, $V_{CM} = 7.5\text{ V}$, $R_L = \infty$
Channel separation	CS	—	120	—	dB	$f = 1\text{ kHz}$
Output sink current	I_{osink}	15	50	—	μA	$V_{IN}^+ = 0\text{ V}$, $V_{IN}^- = 1\text{ V}$, $V_{OL} = 200\text{ mV}$
	I_{osink}	3	9	—	mA	$V_{IN}^+ = 0\text{ V}$, $V_{IN}^- = 1\text{ V}$, $V_{OL} = 1\text{ V}$
Output voltage	V_{OH}	13.2	13.6	—	V	$I_{OH} = -1\text{ mA}$
	V_{OH}	12.0	13.3	—	V	$I_{OH} = -10\text{ mA}$
Output voltage	V_{OL}	—	0.8	1.0	V	$I_{OL} = 1\text{ mA}$
	V_{OL}	—	1.1	1.8	V	$I_{OL} = 10\text{ mA}$

Electrónica S.A. de C.V.

HA17324/A Series

Characteristic Curves

Output Source Current vs. Ambient Temperature

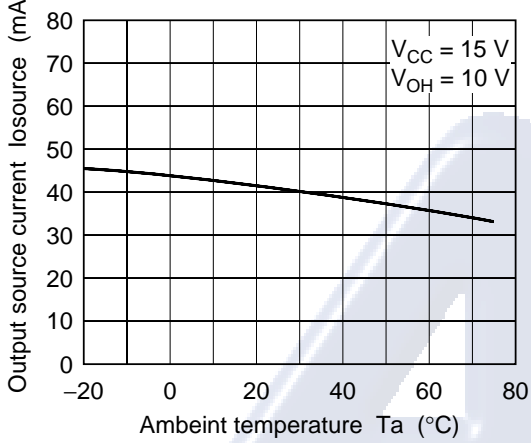

Input Bias Current vs. Ambient Temperature

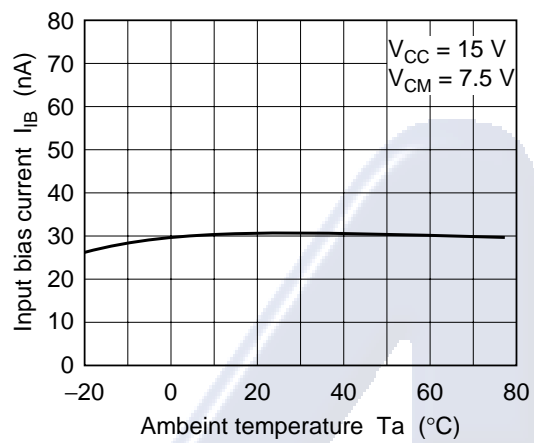

Supply Current vs. Supply Voltage

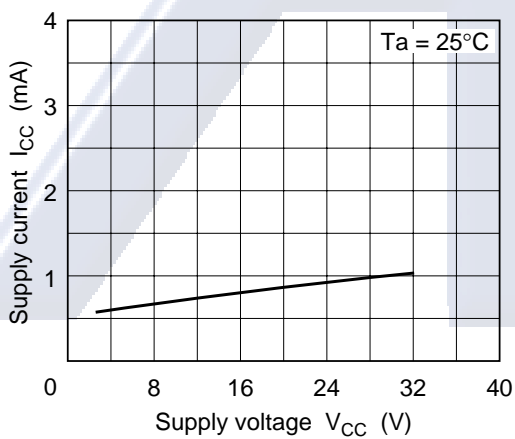

Input Bias Current vs. Supply Voltage

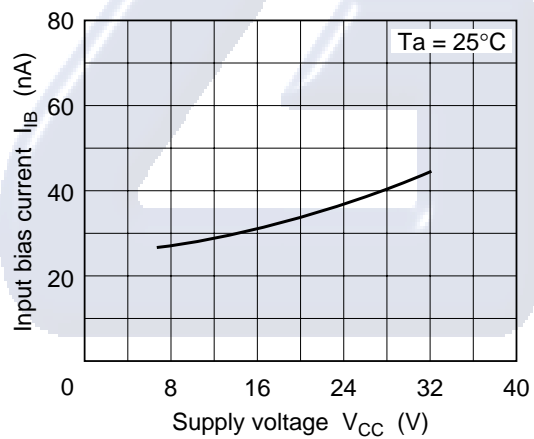

Voltage Gain vs. Supply Voltage

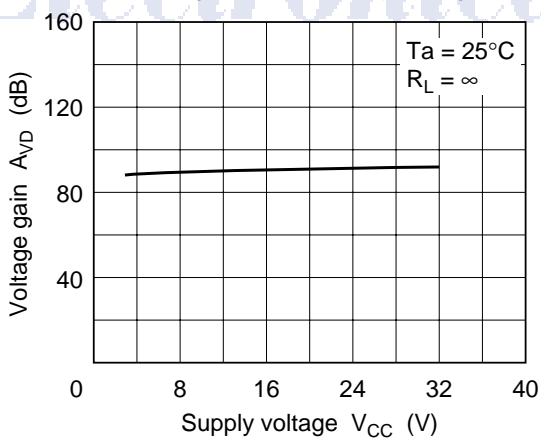

Maximum Output Voltage vs. Frequency

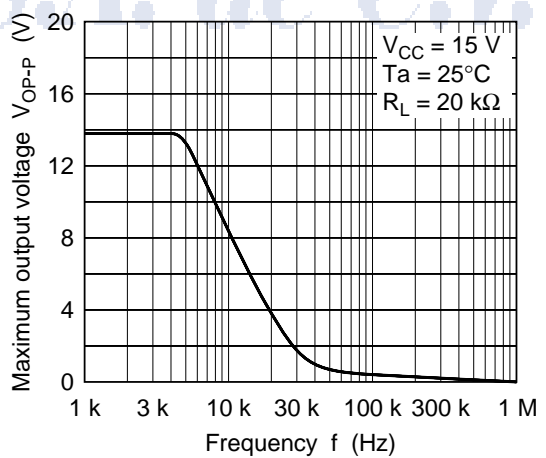

HA17324/A Series

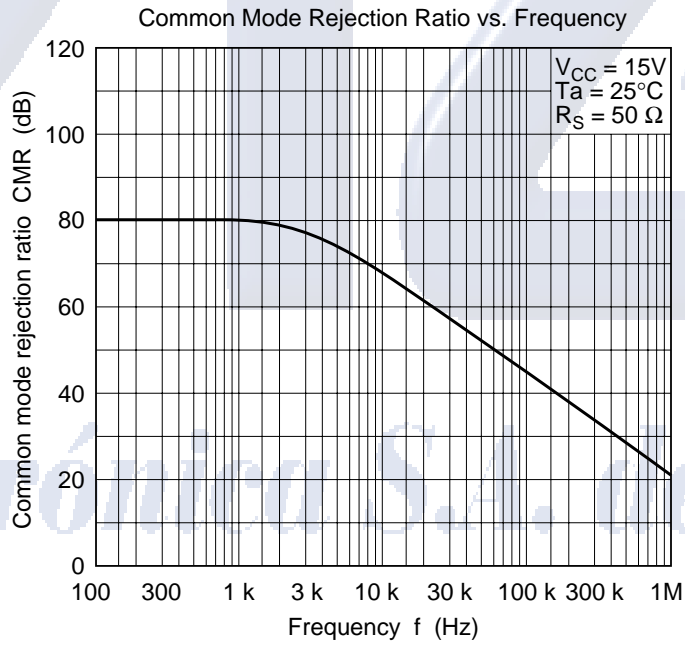
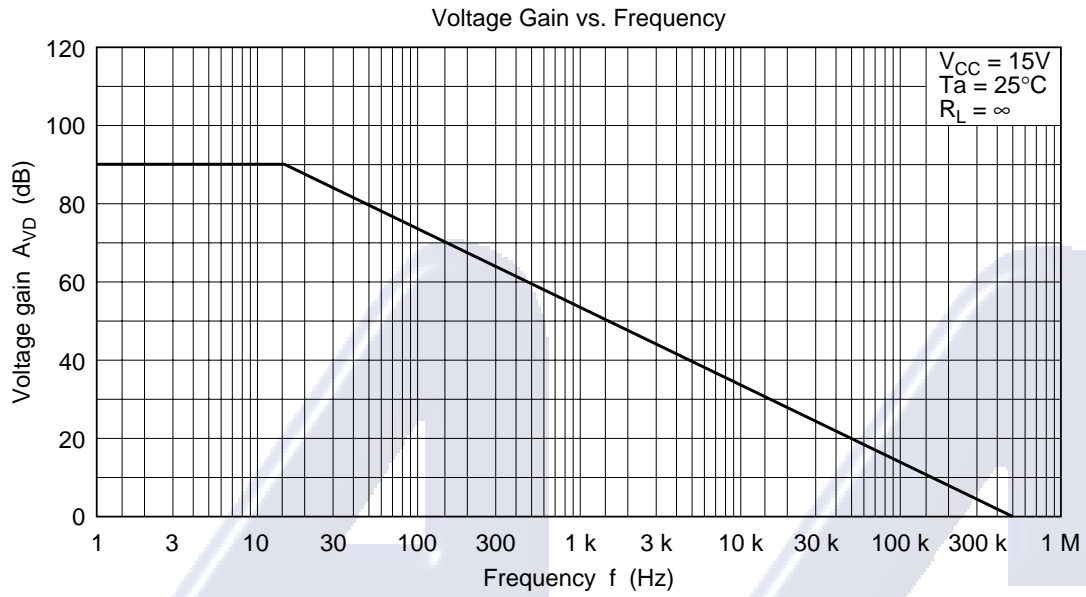

HITACHI

HA17324/A Series

Solder Mounting Method

1. Small and light surface-mount packages require special attentions on solder mounting.
On solder mounting, pre-heating before soldering is needed.
The following figure show an example of infrared rays reflow.
2. The difference of thermal expansion coefficient between mounted substrates and IC leads may cause a failure like solder peeling or solder wet, and electrical characteristics may change by thermal stress.
Therefore, mounting should be done after sufficient confirmation for especially in case of ceramic substrates.

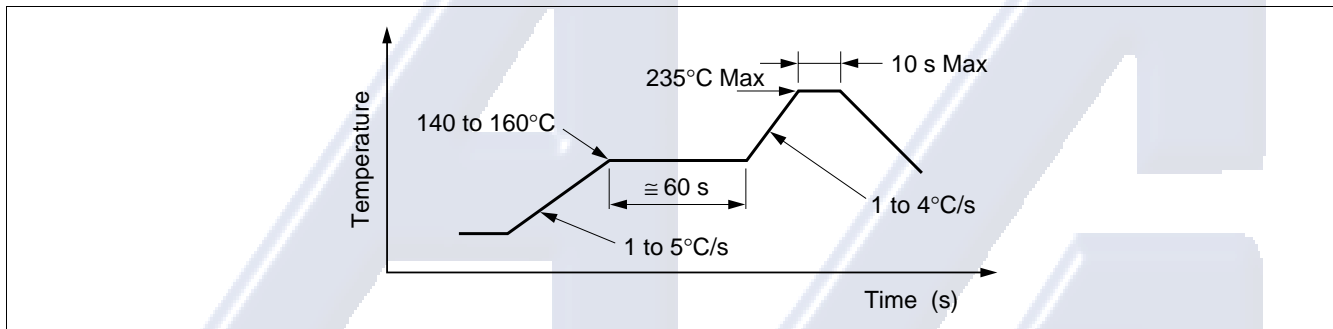

Figure 1 An Example of Infrared Rays Reflow Conditions

Electrónica S.A. de C.V.

HITACHI

HA17324/A Series

Package Dimensions

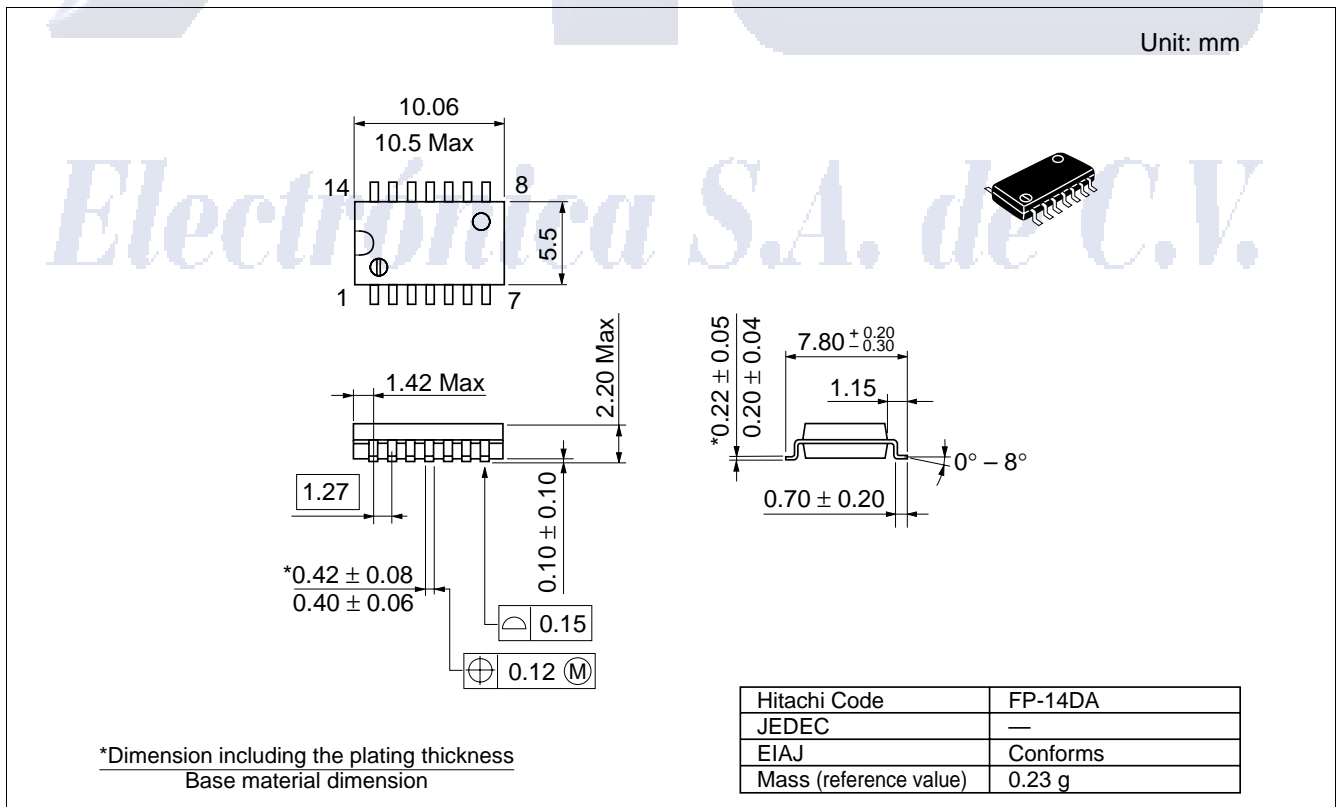
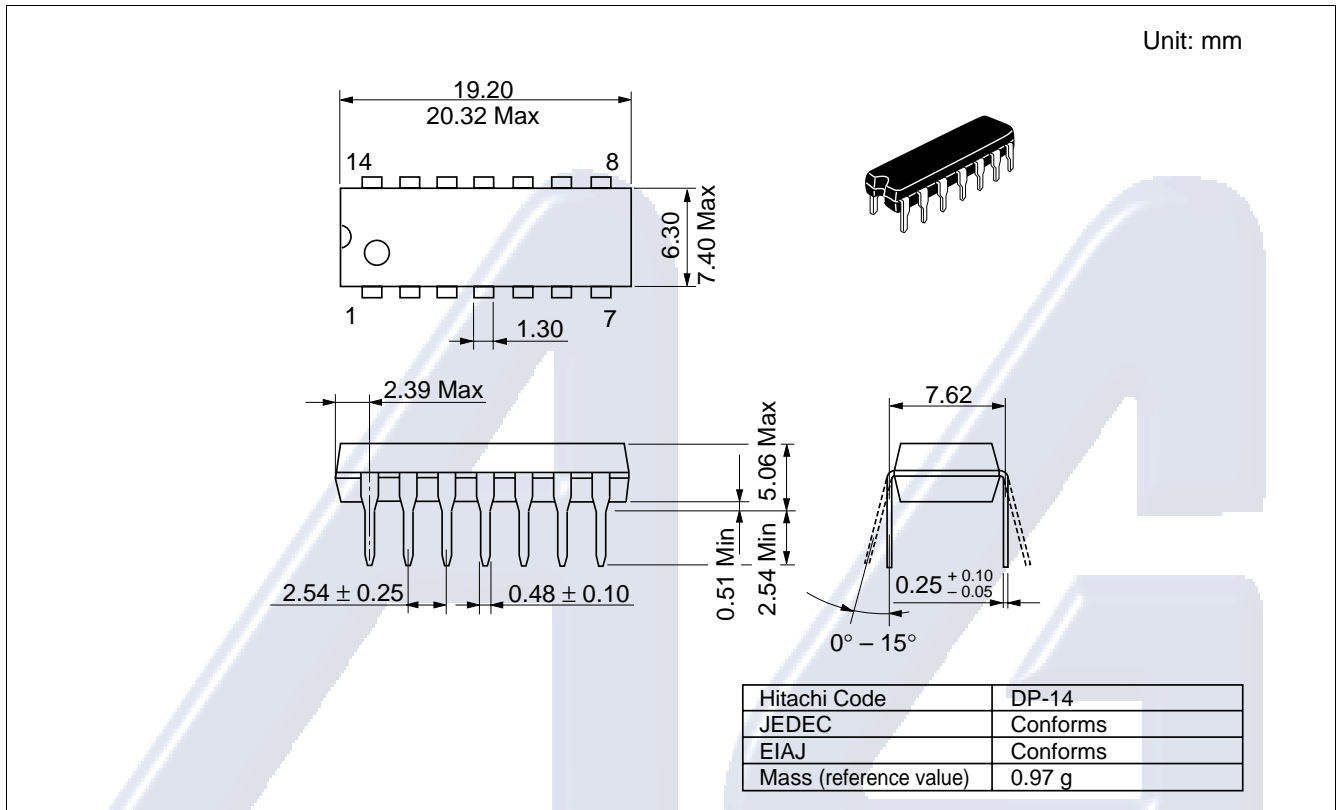

HITACHI

HA17324/A Series

Unit: mm

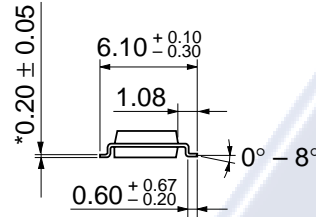
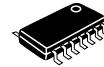
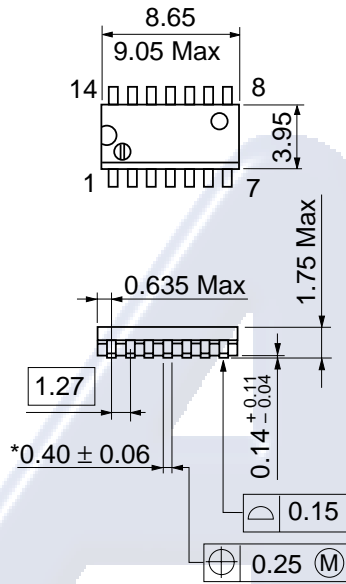

*Pd plating

Hitachi Code	FP-14DN
JEDEC	Conforms
EIAJ	Conforms
Weight (reference value)	0.13 g

Electrónica S.A. de C.V.

HITACHI

Cautions

1. Hitachi neither warrants nor grants licenses of any rights of Hitachi's or any third party's patent, copyright, trademark, or other intellectual property rights for information contained in this document. Hitachi bears no responsibility for problems that may arise with third party's rights, including intellectual property rights, in connection with use of the information contained in this document.
2. Products and product specifications may be subject to change without notice. Confirm that you have received the latest product standards or specifications before final design, purchase or use.
3. Hitachi makes every attempt to ensure that its products are of high quality and reliability. However, contact Hitachi's sales office before using the product in an application that demands especially high quality and reliability or where its failure or malfunction may directly threaten human life or cause risk of bodily injury, such as aerospace, aeronautics, nuclear power, combustion control, transportation, traffic, safety equipment or medical equipment for life support.
4. Design your application so that the product is used within the ranges guaranteed by Hitachi particularly for maximum rating, operating supply voltage range, heat radiation characteristics, installation conditions and other characteristics. Hitachi bears no responsibility for failure or damage when used beyond the guaranteed ranges. Even within the guaranteed ranges, consider normally foreseeable failure rates or failure modes in semiconductor devices and employ systemic measures such as fail-safes, so that the equipment incorporating Hitachi product does not cause bodily injury, fire or other consequential damage due to operation of the Hitachi product.
5. This product is not designed to be radiation resistant.
6. No one is permitted to reproduce or duplicate, in any form, the whole or part of this document without written approval from Hitachi.
7. Contact Hitachi's sales office for any questions regarding this document or Hitachi semiconductor products.

HITACHI

Hitachi, Ltd.

Semiconductor & Integrated Circuits.
Nippon Bldg., 2-6-2, Ohte-machi, Chiyoda-ku, Tokyo 100-0004, Japan
Tel: Tokyo (03) 3270-2111 Fax: (03) 3270-5109

URL North America : <http://semiconductor.hitachi.com/>
 Europe : <http://www.hitachi-eu.com/hel/ecg>
 Asia (Singapore) : <http://www.has.hitachi.com.sg/grp3/sicd/index.htm>
 Asia (Taiwan) : http://www.hitachi.com.tw/E/Product/SICD_Frame.htm
 Asia (HongKong) : <http://www.hitachi.com.hk/eng/bo/grp3/index.htm>
 Japan : <http://www.hitachi.co.jp/Sicd/indx.htm>

For further information write to:

Hitachi Semiconductor
(America) Inc.
179 East Tasman Drive,
San Jose, CA 95134
Tel: <1> (408) 433-1990
Fax: <1> (408) 433-0223

Hitachi Europe GmbH
Electronic components Group
Dornacher Straße 3
D-85622 Feldkirchen, Munich
Germany
Tel: <49> (89) 9 9180-0
Fax: <49> (89) 9 29 30 00

Hitachi Europe Ltd.
Electronic Components Group.
Whitebrook Park
Lower Cookham Road
Maidenhead
Berkshire SL6 8YA, United Kingdom
Tel: <44> (1628) 585000
Fax: <44> (1628) 778322

Hitachi Asia Pte. Ltd.
16 Collyer Quay #20-00
Hitachi Tower
Singapore 049318
Tel: 535-2100
Fax: 535-1533

Hitachi Asia Ltd.
Taipei Branch Office
3F, Hung Kuo Building, No.167,
Tun-Hwa North Road, Taipei (105)
Tel: <886> (2) 2718-3666
Fax: <886> (2) 2718-8180

Hitachi Asia (Hong Kong) Ltd.
Group III (Electronic Components)
7/F., North Tower, World Finance Centre,
Harbour City, Canton Road, Tsim Sha Tsui,
Kowloon, Hong Kong
Tel: <852> (2) 735 9218
Fax: <852> (2) 730 0281
Telex: 40815 HITEC HX

Copyright ' Hitachi, Ltd., 2000. All rights reserved. Printed in Japan.

HITACHI