

# MMSZxxxT1G Series, SZMMSZxxxT1G Series

## Zener Voltage Regulators

### 500 mW SOD-123 Surface Mount

Three complete series of Zener diodes are offered in the convenient, surface mount plastic SOD-123 package. These devices provide a convenient alternative to the leadless 34-package style.

#### Features

- 500 mW Rating on FR-4 or FR-5 Board
- Wide Zener Reverse Voltage Range – 2.4 V to 56 V
- Package Designed for Optimal Automated Board Assembly
- Small Package Size for High Density Applications
- ESD Rating of Class 3 (> 16 kV) per Human Body Model
- AEC-Q101 Qualified and PPAP Capable
- SZ Prefix for Automotive and Other Applications Requiring Unique Site and Control Change Requirements
- Pb-Free Packages are Available\*

#### Mechanical Characteristics

**CASE:** Void-free, transfer-molded, thermosetting plastic case

**FINISH:** Corrosion resistant finish, easily Solderable

**MAXIMUM CASE TEMPERATURE FOR SOLDERING PURPOSES:**

260°C for 10 Seconds

**POLARITY:** Cathode indicated by polarity band

**FLAMMABILITY RATING:** UL 94 V-0

#### MAXIMUM RATINGS

Rating	Symbol	Max	Unit
Total Power Dissipation on FR-5 Board, (Note 1) @ $T_L = 75^\circ\text{C}$ Derated above $75^\circ\text{C}$	$P_D$	500 6.7	mW mW/°C
Thermal Resistance, Junction-to-Ambient (Note 2)	$R_{\theta JA}$	340	°C/W
Thermal Resistance, Junction-to-Lead (Note 2)	$R_{\theta JL}$	150	°C/W
Junction and Storage Temperature Range	$T_J, T_{stg}$	-55 to +150	°C

Stresses exceeding Maximum Ratings may damage the device. Maximum Ratings are stress ratings only. Functional operation above the Recommended Operating Conditions is not implied. Extended exposure to stresses above the Recommended Operating Conditions may affect device reliability.

1. FR-5 = 3.5 X 1.5 inches.

2. Thermal Resistance measurement obtained via infrared Scan Method.

\*For additional information on our Pb-Free strategy and soldering details, please download the ON Semiconductor Soldering and Mounting Techniques Reference Manual, SOLDERRM/D.



**ON Semiconductor®**

<http://onsemi.com>



**SOD-123  
CASE 425  
STYLE 1**

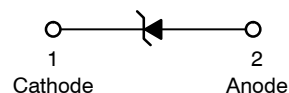

#### MARKING DIAGRAM



xx = Device Code  
M = Date Code  
▪ = Pb-Free Package

(Note: Microdot may be in either location)

#### ORDERING INFORMATION

Device	Package	Shipping†
MMSZxxxT1G	SOD-123 (Pb-Free)	3,000 / Tape & Reel
SZMMSZxxxT1G	SOD-123 (Pb-Free)	3,000 / Tape & Reel
MMSZxxxT3G	SOD-123 (Pb-Free)	10,000 / Tape & Reel
SZMMSZxxxT3G	SOD-123 (Pb-Free)	10,000 / Tape & Reel

†For information on tape and reel specifications, including part orientation and tape sizes, please refer to our Tape and Reel Packaging Specifications Brochure, BRD8011/D.

#### DEVICE MARKING INFORMATION

See specific marking information in the device marking column of the Electrical Characteristics table on page 2 of this data sheet.

## MMSZxxxT1G Series, SZMMSZxxxT1G Series

**ELECTRICAL CHARACTERISTICS** ( $T_A = 25^\circ\text{C}$  unless otherwise noted,  $V_F = 0.95\text{ V Max. @ } I_F = 10\text{ mA}$ )

Symbol	Parameter
$V_Z$	Reverse Zener Voltage @ $I_{ZT}$
$I_{ZT}$	Reverse Current
$Z_{ZT}$	Maximum Zener Impedance @ $I_{ZT}$
$I_R$	Reverse Leakage Current @ $V_R$
$V_R$	Reverse Voltage
$I_F$	Forward Current
$V_F$	Forward Voltage @ $I_F$

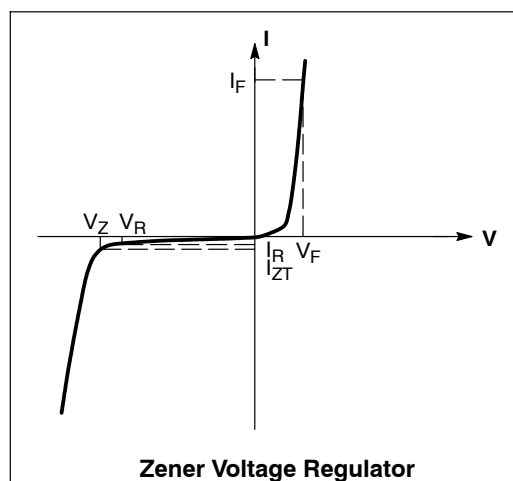

**ELECTRICAL CHARACTERISTICS** ( $T_A = 25^\circ\text{C}$  unless otherwise noted,  $V_F = 0.9\text{ V Max. @ } I_F = 10\text{ mA}$ )

Device*	Device Marking	$V_{Z1}$ (Volts) (Notes 3 and 4)			$Z_{ZT1}$ (Note 5)	$V_{Z2}$ (Volts) (Notes 3 and 4)		$Z_{ZT2}$ (Note 5)	Max Reverse Leakage Current	
		@ $I_{ZT1} = 5\text{ mA}$				@ $I_{ZT2} = 1\text{ mA}$			$I_R @ V_R$	
		Min	Nom	Max	$\Omega$	Min	Max	$\Omega$	$\mu\text{A}$	Volts
MMSZ2V4T1G	T1	2.28	2.4	2.52	100	1.7	2.1	600	50	1
MMSZ2V7T1G	T2	2.57	2.7	2.84	100	1.9	2.4	600	20	1
MMSZ3V0T1G	T3	2.85	3.0	3.15	95	2.1	2.7	600	10	1
MMSZ3V3T1G	T4	3.14	3.3	3.47	95	2.3	2.9	600	5	1
MMSZ3V6T1G	T5	3.42	3.6	3.78	90	2.7	3.3	600	5	1
MMSZ3V9T1G	U1	3.71	3.9	4.10	90	2.9	3.5	600	3	1
MMSZ4V3T1G	U2	4.09	4.3	4.52	90	3.3	4.0	600	3	1
MMSZ4V7T1G	U3	4.47	4.7	4.94	80	3.7	4.7	500	3	2
<b>MMSZ5V1T1G</b>	<b>U4</b>	<b>4.85</b>	<b>5.1</b>	<b>5.36</b>	<b>60</b>	<b>4.2</b>	<b>5.3</b>	<b>480</b>	<b>2</b>	<b>2</b>
<b>MMSZ5V6T1G/T3G</b>	<b>U5</b>	<b>5.32</b>	<b>5.6</b>	<b>5.88</b>	<b>40</b>	<b>4.8</b>	<b>6.0</b>	<b>400</b>	<b>1</b>	<b>2</b>
<b>MMSZ6V2T1G</b>	<b>V1</b>	<b>5.89</b>	<b>6.2</b>	<b>6.51</b>	<b>10</b>	<b>5.6</b>	<b>6.6</b>	<b>150</b>	<b>3</b>	<b>4</b>
MMSZ6V8T1G	V2	6.46	6.8	7.14	15	6.3	7.2	80	2	4
MMSZ7V5T1G	V3	7.13	7.5	7.88	15	6.9	7.9	80	1	5
MMSZ8V2T1G	V4	7.79	8.2	8.61	15	7.6	8.7	80	0.7	5
MMSZ9V1T1G	V5	8.65	9.1	9.56	15	8.4	9.6	100	0.5	6
MMSZ10T1G	A1	9.50	10	10.50	20	9.3	10.6	150	0.2	7
MMSZ11T1G	A2	10.45	11	11.55	20	10.2	11.6	150	0.1	8
MMSZ12T1G	A3	11.40	12	12.60	25	11.2	12.7	150	0.1	8
MMSZ13T1G	A4	12.35	13	13.65	30	12.3	14.0	170	0.1	8
MMSZ15T1G	A5	14.25	15	15.75	30	13.7	15.5	200	0.05	10.5
MMSZ16T1G	X1	15.20	16	16.80	40	15.2	17.0	200	0.05	11.2
<b>MMSZ18T1G/T3G</b>	<b>X2</b>	<b>17.10</b>	<b>18</b>	<b>18.90</b>	<b>45</b>	<b>16.7</b>	<b>19.0</b>	<b>225</b>	<b>0.05</b>	<b>12.6</b>
MMSZ20T1G	X3	19.00	20	21.00	55	18.7	21.1	225	0.05	14
MMSZ22T1G	X4	20.90	22	23.10	55	20.7	23.2	250	0.05	15.4
MMSZ24T1G	X5	22.80	24	25.20	70	22.7	25.5	250	0.05	16.8

3. The type numbers shown have a standard tolerance of  $\pm 5\%$  on the nominal Zener Voltage.

4. Tolerance and Voltage Designation: Zener Voltage ( $V_Z$ ) is measured with the Zener Current applied for  $PW = 1\text{ ms}$ .

5.  $Z_{ZT}$  and  $Z_{ZK}$  are measured by dividing the AC voltage drop across the device by the AC current applied.

The specified limits are for  $I_{Z(AC)} = 0.1 I_{Z(DC)}$ , with the AC frequency = 1 kHz.

\*Include SZ-prefix devices where applicable.

## MMSZxxxT1G Series, SZMMSZxxxT1G Series

**ELECTRICAL CHARACTERISTICS** ( $T_A = 25^\circ\text{C}$  unless otherwise noted,  $V_F = 0.9\text{ V Max.}$  @  $I_F = 10\text{ mA}$ )

Device*	Device Marking	$V_{Z1}$ (Volts) (Notes 6 and 7)			$Z_{ZT1}$ (Note 8)	$V_{Z2}$ (Volts) (Notes 6 and 7)		$Z_{ZT2}$ (Note 8)	Max Reverse Leakage Current	
		@ $I_{ZT1} = 2\text{ mA}$				@ $I_{ZT2} = 0.1\text{ mA}$		@ $I_{ZT2} = 0.5\text{ mA}$	$I_R @ V_R$	
		Min	Nom	Max	$\Omega$	Min	Max	$\Omega$	$\mu\text{A}$	Volts
MMSZ27T1G/T3G	Y1	25.65	27	28.35	80	25	28.9	300	0.05	18.9
MMSZ30T1G	Y2	28.50	30	31.50	80	27.8	32	300	0.05	21
MMSZ33T1G	Y3	31.35	33	34.65	80	30.8	35	325	0.05	23.1
MMSZ36T1G	Y4	34.20	36	37.80	90	33.8	38	350	0.05	25.2
MMSZ39T1G	Y5	37.05	39	40.95	130	36.7	41	350	0.05	27.3
MMSZ43T1G	Z1	40.85	43	45.15	150	39.7	46	375	0.05	30.1
MMSZ47T1G	Z2	44.65	47	49.35	170	43.7	50	375	0.05	32.9
MMSZ51T1G	Z3	48.45	51	53.55	180	47.6	54	400	0.05	35.7
MMSZ56T1G	Z4	53.20	56	58.80	200	51.5	60	425	0.05	39.2

6. The type numbers shown have a standard tolerance of  $\pm 5\%$  on the nominal Zener Voltage.

7. Tolerance and Voltage Designation: Zener Voltage ( $V_Z$ ) is measured with the Zener Current applied for  $PW = 1\text{ ms}$ .

8.  $Z_{ZT}$  and  $Z_{ZK}$  are measured by dividing the AC voltage drop across the device by the AC current applied.

The specified limits are for  $I_{Z(AC)} = 0.1 I_{Z(DC)}$ , with the AC frequency = 1 kHz.

\*Include SZ-prefix devices where applicable.

# MMSZxxxT1G Series, SZMMSZxxxT1G Series

## TYPICAL CHARACTERISTICS

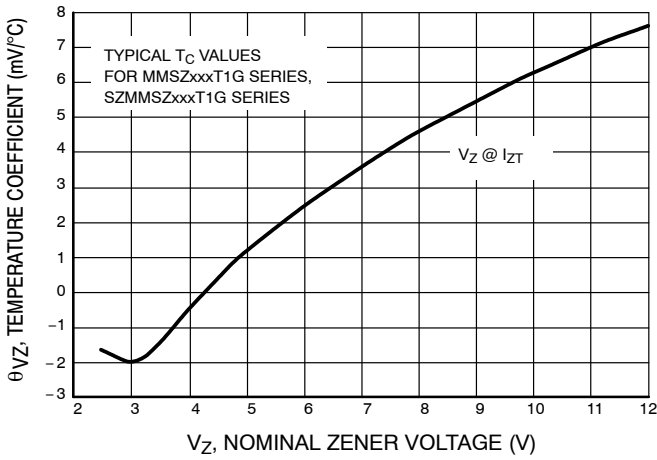

**Figure 1. Temperature Coefficients (Temperature Range -55°C to +150°C)**

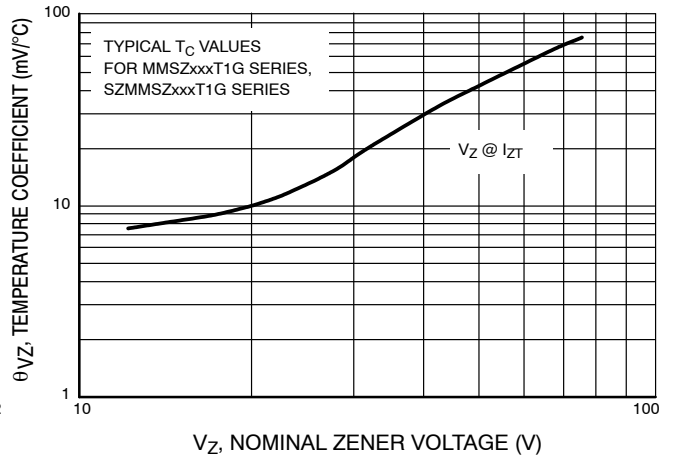

**Figure 2. Temperature Coefficients (Temperature Range -55°C to +150°C)**

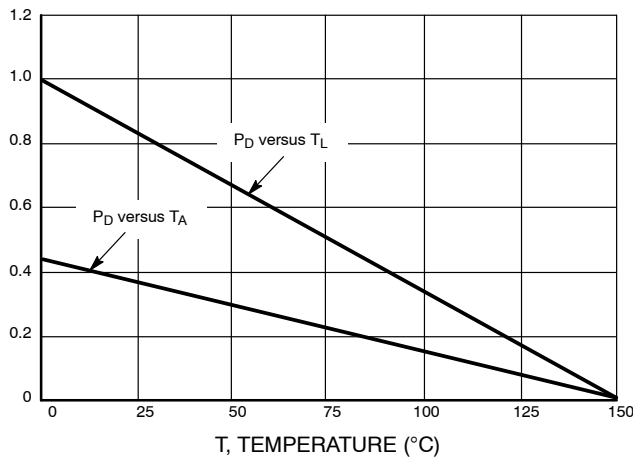

**Figure 3. Steady State Power Derating**

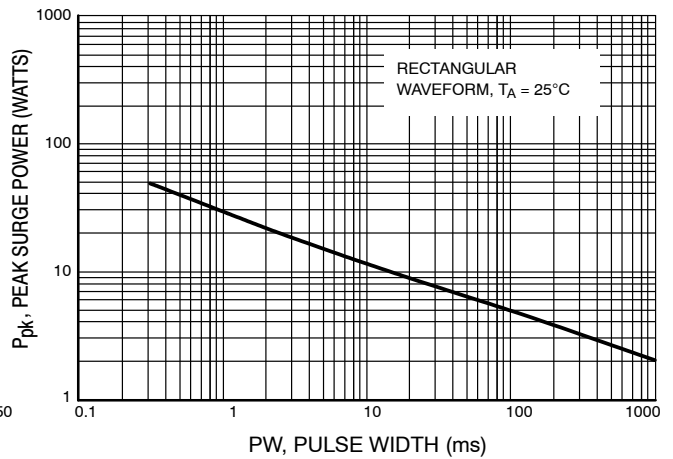

**Figure 4. Maximum Nonrepetitive Surge Power**

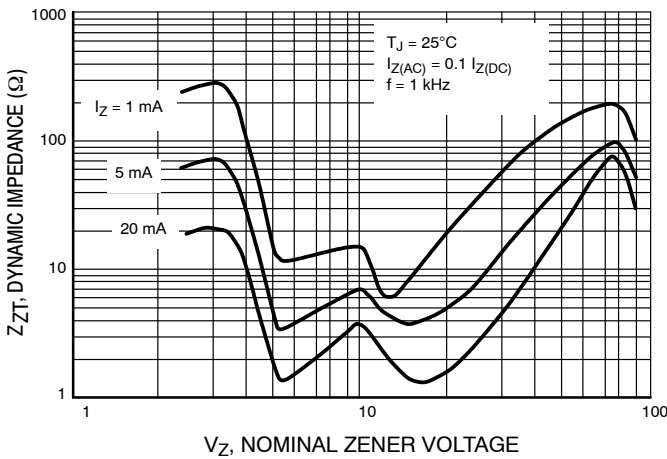

**Figure 5. Effect of Zener Voltage on Zener Impedance**

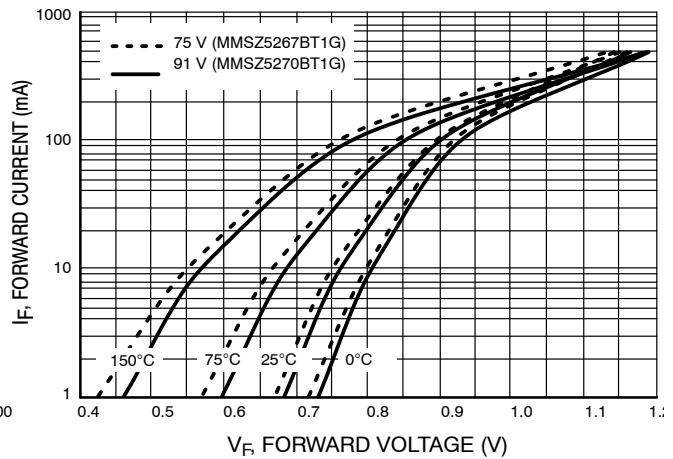

**Figure 6. Typical Forward Voltage**

# MMSZxxxT1G Series, SZMMSZxxxT1G Series

## TYPICAL CHARACTERISTICS

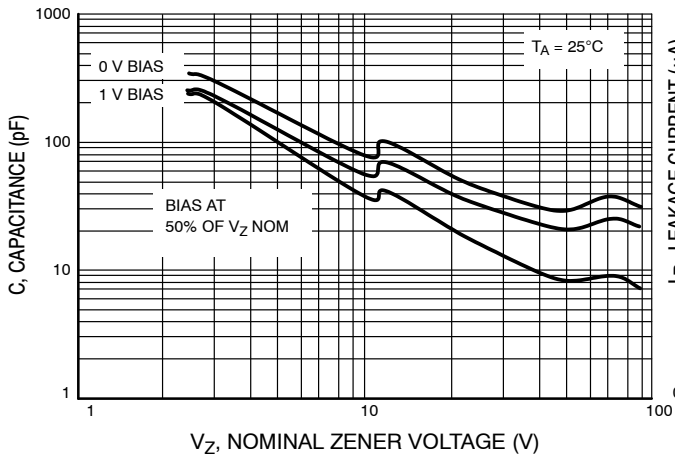

Figure 7. Typical Capacitance

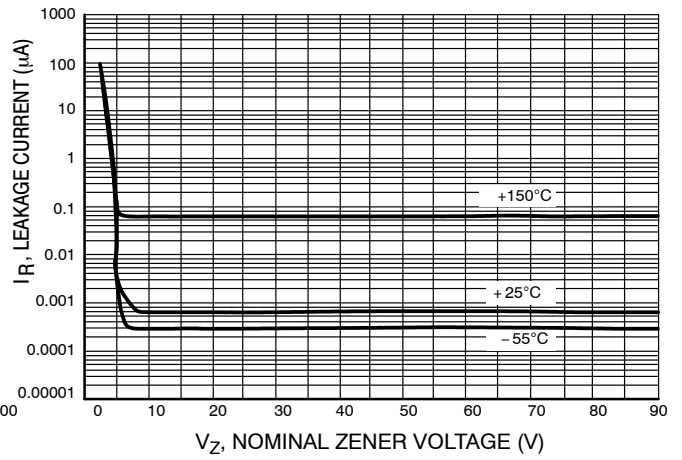

Figure 8. Typical Leakage Current

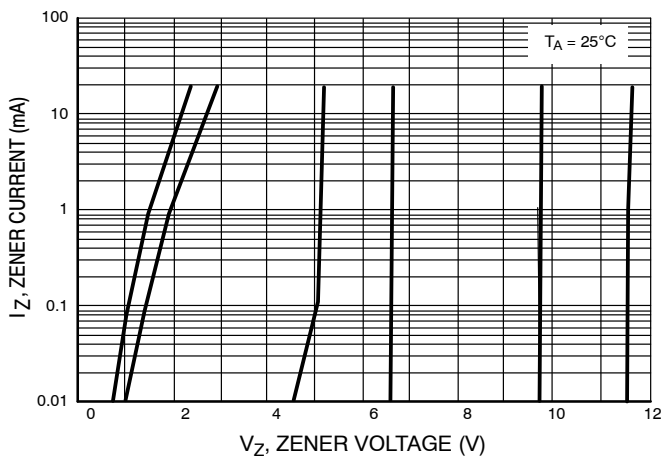

Figure 9. Zener Voltage versus Zener Current ( $V_Z$  Up to 12 V)

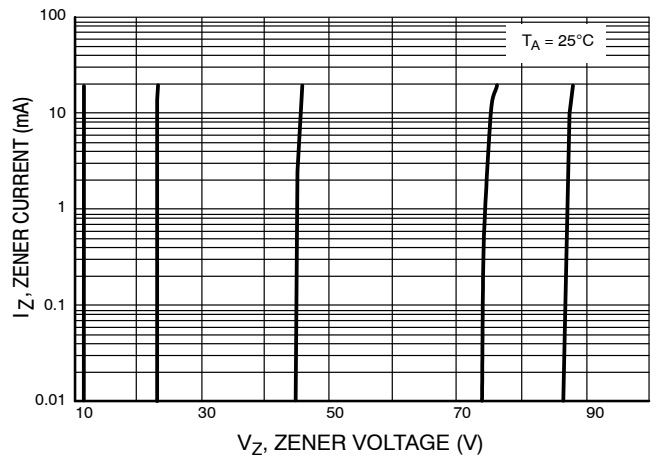
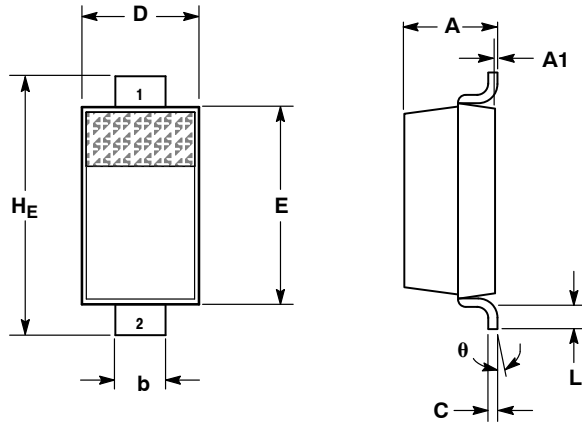

Figure 10. Zener Voltage versus Zener Current (12 V to 91 V)

# MMSZxxxT1G Series, SZMMSZxxxT1G Series

## PACKAGE DIMENSIONS

SOD-123  
CASE 425-04  
ISSUE G



- NOTES:  
1. DIMENSIONING AND TOLERANCING PER ANSI Y14.5M, 1982.  
2. CONTROLLING DIMENSION: INCH.

DIM	MILLIMETERS			INCHES		
	MIN	NOM	MAX	MIN	NOM	MAX
A	0.94	1.17	1.35	0.037	0.046	0.053
A1	0.00	0.05	0.10	0.000	0.002	0.004
b	0.51	0.61	0.71	0.020	0.024	0.028
c	---	---	0.15	---	---	0.006
D	1.40	1.60	1.80	0.055	0.063	0.071
E	2.54	2.69	2.84	0.100	0.106	0.112
HE	3.56	3.68	3.86	0.140	0.145	0.152
L	0.25	---	---	0.010	---	---
theta	0°	---	10°	0°	---	10°

STYLE 1:  
PIN 1. CATHODE  
2. ANODE

## SOLDERING FOOTPRINT\*

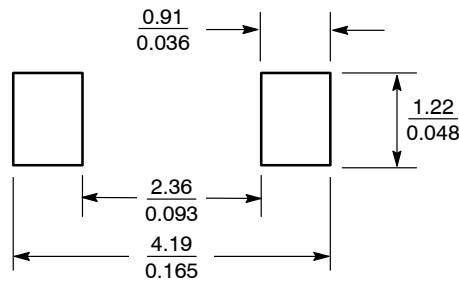

SCALE 10:1 (mm/inches)

\*For additional information on our Pb-Free strategy and soldering details, please download the ON Semiconductor Soldering and Mounting Techniques Reference Manual, SOLDERRM/D.

ON Semiconductor and are registered trademarks of Semiconductor Components Industries, LLC (SCILLC). SCILLC reserves the right to make changes without further notice to any products herein. SCILLC makes no warranty, representation or guarantee regarding the suitability of its products for any particular purpose, nor does SCILLC assume any liability arising out of the application or use of any product or circuit, and specifically disclaims any and all liability, including without limitation special, consequential or incidental damages. "Typical" parameters which may be provided in SCILLC data sheets and/or specifications can and do vary in different applications and actual performance may vary over time. All operating parameters, including "Typicals" must be validated for each customer application by customer's technical experts. SCILLC does not convey any license under its patent rights nor the rights of others. SCILLC products are not designed, intended, or authorized for use as components in systems intended for surgical implant into the body, or other applications intended to support or sustain life, or for any other application in which the failure of the SCILLC product could create a situation where personal injury or death may occur. Should Buyer purchase or use SCILLC products for any such unintended or unauthorized application, Buyer shall indemnify and hold SCILLC and its officers, employees, subsidiaries, affiliates, and distributors harmless against all claims, costs, damages, and expenses, and reasonable attorney fees arising out of, directly or indirectly, any claim of personal injury or death associated with such unintended or unauthorized use, even if such claim alleges that SCILLC was negligent regarding the design or manufacture of the part. SCILLC is an Equal Opportunity/Affirmative Action Employer. This literature is subject to all applicable copyright laws and is not for resale in any manner.

## PUBLICATION ORDERING INFORMATION

LITERATURE FULFILLMENT:  
Literature Distribution Center for ON Semiconductor  
P.O. Box 5163, Denver, Colorado 80217 USA  
Phone: 303-675-2175 or 800-344-3860 Toll Free USA/Canada  
Fax: 303-675-2176 or 800-344-3867 Toll Free USA/Canada  
Email: orderlit@onsemi.com

N. American Technical Support: 800-282-9855 Toll Free  
USA/Canada  
Europe, Middle East and Africa Technical Support:  
Phone: 421 33 790 2910  
Japan Customer Focus Center  
Phone: 81-3-5817-1050

ON Semiconductor Website: [www.onsemi.com](http://www.onsemi.com)

Order Literature: <http://www.onsemi.com/orderlit>

For additional information, please contact your local Sales Representative

MMSZ2V4T1/D