

SN55182, SN75182 DUAL DIFFERENTIAL LINE RECEIVERS

SLLS092D – OCTOBER 1972 – REVISED APRIL 1998

- Single 5-V Supply
- Differential Line Operation
- Dual Channels
- TTL Compatibility
- ±15-V Common-Mode Input Voltage Range
- ±15-V Differential Input Voltage Range
- Individual Channel Strobes
- Built-In Optional Line-Termination Resistor
- Individual Frequency Response Controls
- Designed for Use With Dual Differential Drivers SN55183 and SN75183
- Designed to Be Interchangeable With National Semiconductor DS7820A and DS8820A

description

The SN55182 and SN75182 dual differential line receivers are designed to sense small differential signals in the presence of large common-mode noise. These devices give TTL-compatible output signals as a function of the polarity of the differential input voltage. The frequency response of each channel can be easily controlled by a single external capacitor to provide immunity to differential noise spikes. The output goes to a high level when the inputs are open circuited. A strobe input (STRB) is provided that, when in the low level, disables the receiver and forces the output to a high level.

The receiver is of monolithic single-chip construction, and both halves of the dual circuits use common power-supply and ground terminals.

The SN55182 is characterized for operation over the full military temperature range of -55°C to 125°C. The SN75182 is characterized for operation from 0°C to 70°C.

SN55182 . . . J OR W PACKAGE
SN75182 . . . N PACKAGE
(TOP VIEW)

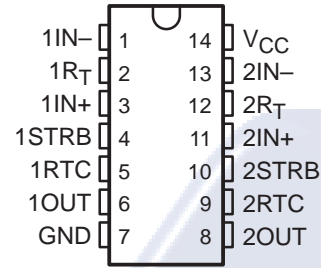

SN55182 . . . FK PACKAGE
(TOP VIEW)

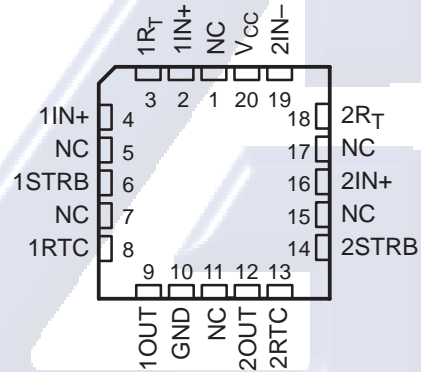

NC – No internal connection

**THE SN55182 IS NOT RECOMMENDED
FOR NEW DESIGNS**

FUNCTION TABLE

INPUTS		OUTPUT OUT
STRB	V _{ID}	
L	X	H
H	H	H
H	L	L

H = $V_I \geq V_{IH \text{ min}}$ or V_{ID} more positive than $V_{TH \text{ max}}$
L = $V_I \leq V_{IL \text{ max}}$ or V_{ID} more negative than $V_{TL \text{ max}}$
X = irrelevant



Please be aware that an important notice concerning availability, standard warranty, and use in critical applications of Texas Instruments semiconductor products and disclaimers thereto appears at the end of this data sheet.

PRODUCTION DATA information is current as of publication date. Products conform to specifications per the terms of Texas Instruments standard warranty. Production processing does not necessarily include testing of all parameters.



POST OFFICE BOX 655303 • DALLAS, TEXAS 75265

Copyright © 1998, Texas Instruments Incorporated

SN55182, SN75182 DUAL DIFFERENTIAL LINE RECEIVERS

SLLS092D – OCTOBER 1972 – REVISED APRIL 1998

logic symbol†

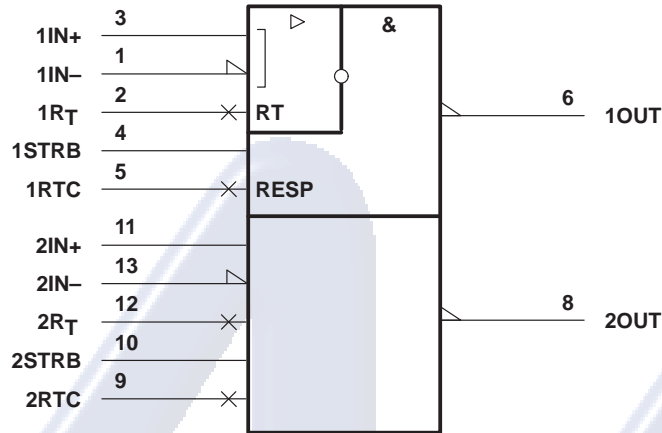

† This symbol is in accordance with ANSI/IEEE Std 91-1984 and IEC Publication 617-12. Pin numbers shown are for the J, N, and W packages.

logic diagram (positive logic)

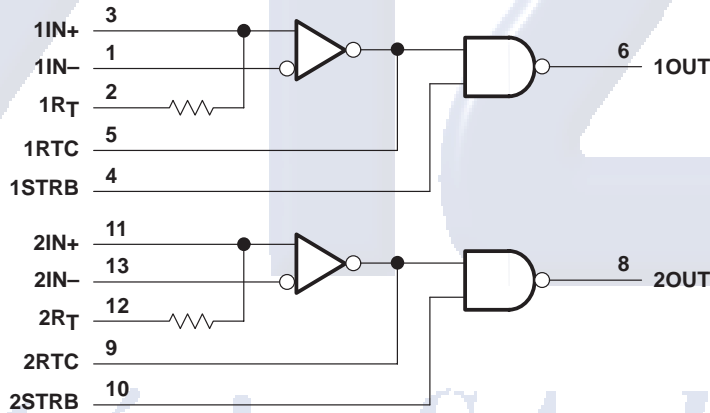

Pin numbers shown are for the J, N, and W packages.

Electrónica S.A. de C.V.

SN55182, SN75182 DUAL DIFFERENTIAL LINE RECEIVERS

SLLS092D – OCTOBER 1972 – REVISED APRIL 1998

schematic (each receiver)

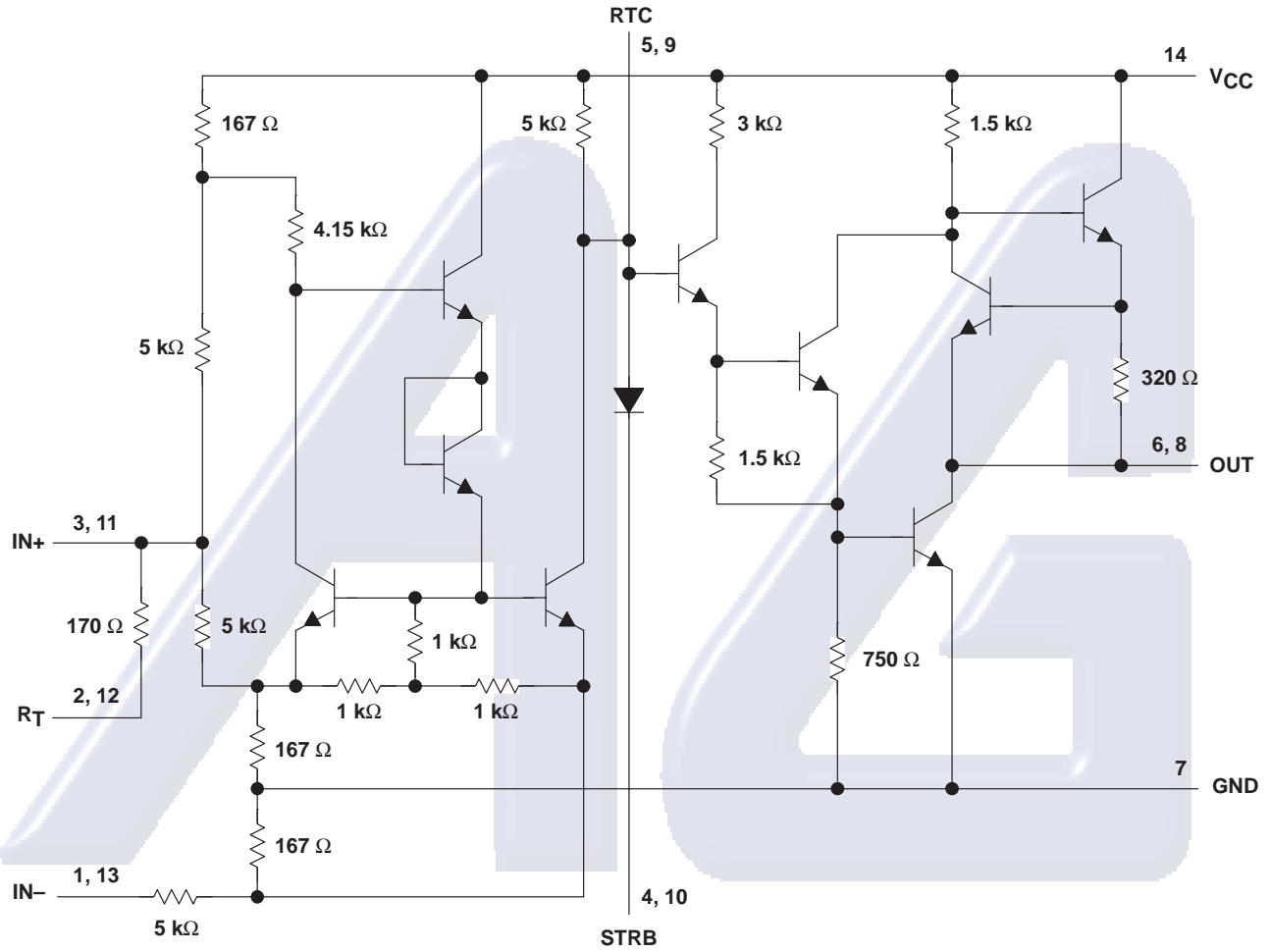

Resistor values shown are nominal.
Pin numbers shown are for the J, N, and W packages.

Electrónica S.A. de C.V.



SN55182, SN75182 DUAL DIFFERENTIAL LINE RECEIVERS

SLLS092D – OCTOBER 1972 – REVISED APRIL 1998

absolute maximum ratings over operating free-air temperature range (unless otherwise noted)†

Supply voltage, V_{CC} (see Note 1)	8 V
Common-mode input voltage, V_{IC}	± 20 V
Differential input voltage, V_{ID} (see Note 2)	± 20 V
Strobe input voltage, $V_{I(STRB)}$	8 V
Output sink current	50 mA
Continuous total power dissipation	See Dissipation Rating Table
Storage temperature range, T_{stg}	-65°C to 150°C
Lead temperature 1,6 mm (1/16 inch) from case for 10 seconds: N package	260°C
Lead temperature 1,6 mm (1/16 inch) from case for 60 seconds: J or W package	300°C
Case temperature for 60 seconds, T_C : FK package	260°C

† Stresses beyond those listed under "absolute maximum ratings" may cause permanent damage to the device. These are stress ratings only, and functional operation of the device at these or any other conditions beyond those indicated under "recommended operating conditions" is not implied. Exposure to absolute-maximum-rated conditions for extended periods may affect device reliability.

- NOTES: 1. All voltage values, except differential voltages, are with respect to network ground terminal.
2. Differential voltage values are at the noninverting terminal with respect to the inverting terminal.

DISSIPATION RATING TABLE

PACKAGE	$T_A \leq 25^{\circ}\text{C}$	DERATING FACTOR ABOVE $T_A = 25^{\circ}\text{C}$	$T_A = 70^{\circ}\text{C}$	$T_A = 125^{\circ}\text{C}$
	POWER RATING		POWER RATING	POWER RATING
FK‡	1375 mW	11.0 mW/ $^{\circ}\text{C}$	880 mW	275 mW
J‡	1375 mW	11.0 mW/ $^{\circ}\text{C}$	880 mW	275 mW
N	1150 mW	9.2 mW/ $^{\circ}\text{C}$	736 mW	–
W‡	1000 mW	8.0 mW/ $^{\circ}\text{C}$	640 mW	200 mW

‡ In the FK, J, and W packages, SN55182 chips are alloy mounted.

recommended operating conditions

	SN55182			SN75182			UNIT
	MIN	NOM	MAX	MIN	NOM	MAX	
Supply voltage, V_{CC}	4.5	5	5.5	4.5	5	5.5	V
Common-mode input voltage, V_{IC}			± 15			± 15	V
High-level strobe input voltage, $V_{IH(STRB)}$	2.1		5.5	2.1		5.5	V
Low-level strobe input voltage, $V_{IL(STRB)}$	0		0.9	0		0.9	V
High-level output current, I_{OH}			–400			–400	μA
Low-level output current, I_{OL}			16			16	mA
Operating free-air temperature, T_A	–55		125	0		70	$^{\circ}\text{C}$



POST OFFICE BOX 655303 • DALLAS, TEXAS 75265

SN55182, SN75182

DUAL DIFFERENTIAL LINE RECEIVERS

SLLS092D – OCTOBER 1972 – REVISED APRIL 1998

electrical characteristics over recommended ranges of V_{CC} , V_{IC} , and operating free-air temperature (unless otherwise noted)

PARAMETER		TEST CONDITIONS†		MIN	TYP‡	MAX	UNIT	
V_{IT+}	Positive-going input threshold voltage	$V_O = 2.5\text{ V}$, $I_{OH} = -400\ \mu\text{A}$	$V_{IC} = -3\text{ V to }3\text{ V}$			0.5	V	
			$V_{IC} = -15\text{ V to }15\text{ V}$			1		
V_{IT-}	Negative-going input threshold voltage	$V_O = 0.4\text{ V}$, $I_{OL} = 16\text{ mA}$	$V_{IC} = -3\text{ V to }3\text{ V}$			-0.5	V	
			$V_{IC} = -15\text{ V to }15\text{ V}$			-1		
V_{OH}	High-level output voltage	$V_{ID} = 1\text{ V}$, $V(\text{STRB}) = 2.1\text{ V}$, $I_{OH} = -400\ \mu\text{A}$		2.5	4.2	5.5	V	
			$V_{ID} = -1\text{ V}$, $V(\text{STRB}) = 0.4\text{ V}$, $I_{OH} = -400\ \mu\text{A}$	2.5	4.2	5.5		
V_{OL}	Low-level output voltage	$V_{ID} = -1\text{ V}$, $V(\text{STRB}) = 2.1\text{ V}$, $I_{OL} = 16\text{ mA}$		0.25	0.4		V	
I_I	Input current		Inverting input	$V_{IC} = 15\text{ V}$		3	4.2	mA
				$V_{IC} = 0$		0	-0.5	
				$V_{IC} = -15\text{ V}$		-3	-4.2	
			Noninverting input	$V_{IC} = 15\text{ V}$		5	7	
				$V_{IC} = 0$		-1	-1.4	
				$V_{IC} = -15\text{ V}$		-7	-9.8	
$I_{IH}(\text{STRB})$	High-level strobe input current	$V(\text{STRB}) = 5.5\text{ V}$			5	μA		
$I_{IL}(\text{STRB})$	Low-level strobe input current	$V(\text{STRB}) = 0$			-1	-1.4	mA	
r_i	Input resistance		Inverting input	3.6	5		k Ω	
			Noninverting input	1.8	2.5			
	Line-terminating resistance	$T_A = 25^\circ\text{C}$		120	170	250	Ω	
I_{OS}	Short-circuit output current	$V_{CC} = 5.5\text{ V}$, $V_O = 0$		-2.8	-4.5	-6.7	mA	
I_{CC}	Supply current (average per receiver)		$V_{IC} = 15\text{ V}$, $V_{ID} = -1\text{ V}$		4.2	6	mA	
			$V_{IC} = 0$, $V_{ID} = -0.5\text{ V}$		6.8	10.2		
			$V_{IC} = -15\text{ V}$, $V_{ID} = -1\text{ V}$		9.4	14		

† Unless otherwise noted, $V(\text{STRB}) \geq 2.1\text{ V}$ or open.‡ All typical values are at $V_{CC} = 5\text{ V}$, $V_{IC} = 0$, and $T_A = 25^\circ\text{C}$.

switching characteristics, $V_{CC} = 5\text{ V}$, $T_A = 25^\circ\text{C}$

PARAMETER		TEST CONDITIONS			MIN	TYP	MAX	UNIT
$t_{PLH}(\text{D})$	Propagation delay time, low- to high-level output from differential input	$R_L = 400\ \Omega$,	$C_L = 15\text{ pF}$,	see Figure 1		18	40	ns
$t_{PHL}(\text{D})$	Propagation delay time, high- to low-level output from differential input	$R_L = 400\ \Omega$,	$C_L = 15\text{ pF}$,	see Figure 1		31	45	ns
$t_{PLH}(\text{S})$	Propagation delay time, low- to high-level output from STRB input	$R_L = 400\ \Omega$,	$C_L = 15\text{ pF}$,	see Figure 1		9	30	ns
$t_{PHL}(\text{S})$	Propagation delay time, high- to low-level output from STRB input	$R_L = 400\ \Omega$,	$C_L = 15\text{ pF}$,	see Figure 1		15	25	ns



SN55182, SN75182 DUAL DIFFERENTIAL LINE RECEIVERS

SLLS092D – OCTOBER 1972 – REVISED APRIL 1998

PARAMETER MEASUREMENT INFORMATION

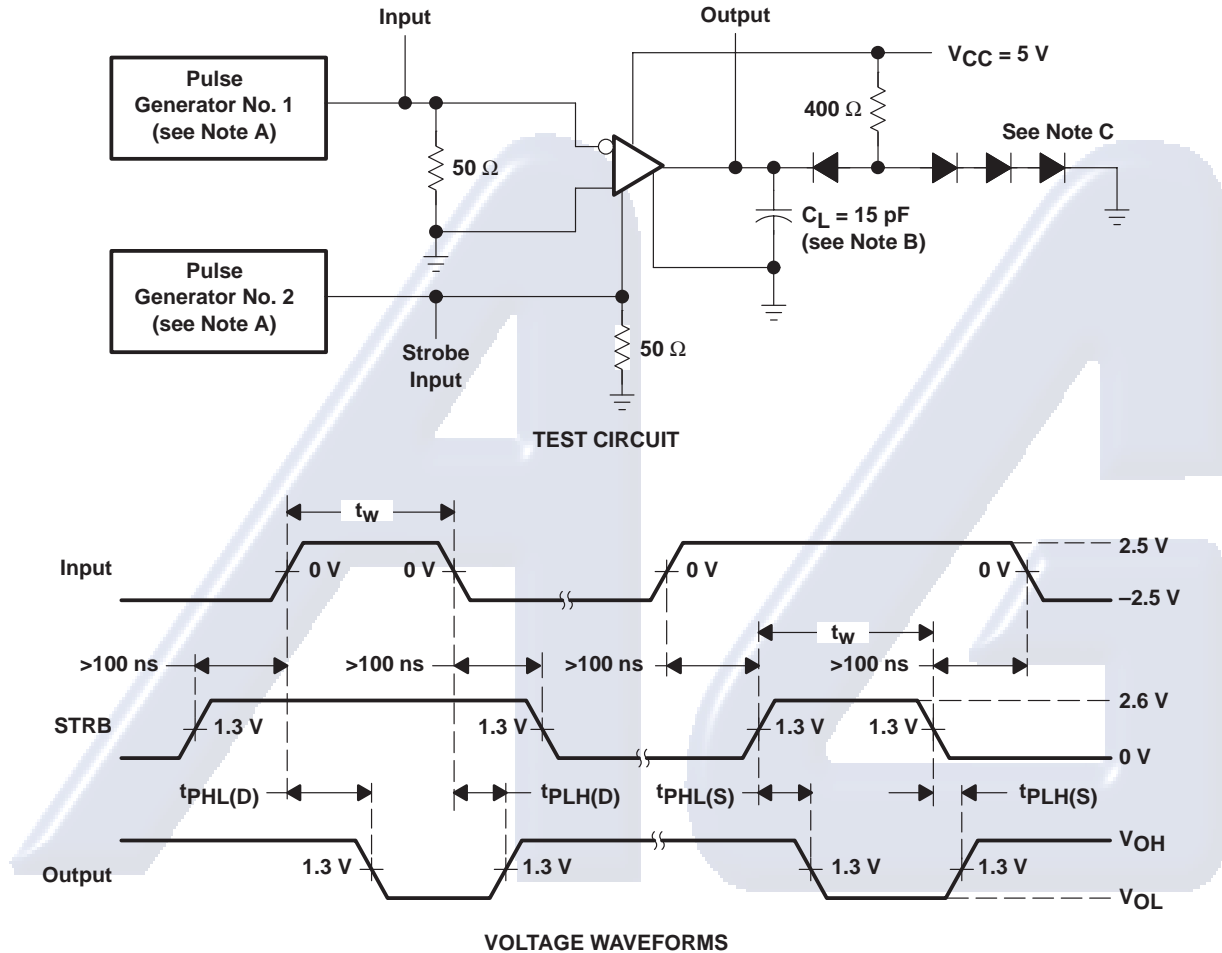

- NOTES: A. The pulse generators have the following characteristics: $Z_O = 50 \Omega$, $t_r \leq 10 \text{ ns}$, $t_f \leq 10 \text{ ns}$, $t_w = 0.5 \pm 0.1 \mu\text{s}$, $\text{PRR} \leq 1 \text{ MHz}$.
 B. C_L includes probe and jig capacitance.
 C. All diodes are 1N3064 or equivalent.

Figure 1. Test Circuit and Voltage Waveforms

SN55182, SN75182 DUAL DIFFERENTIAL LINE RECEIVERS

SLLS092D – OCTOBER 1972 – REVISED APRIL 1998

TYPICAL CHARACTERISTICS†

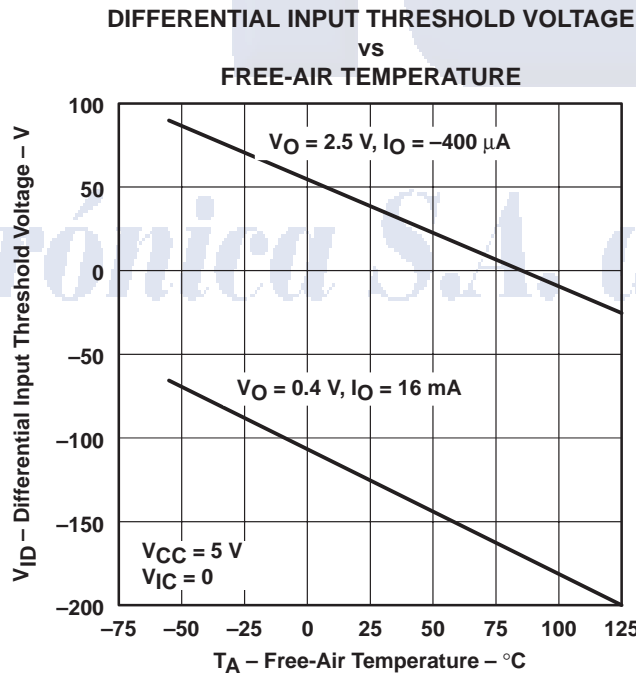
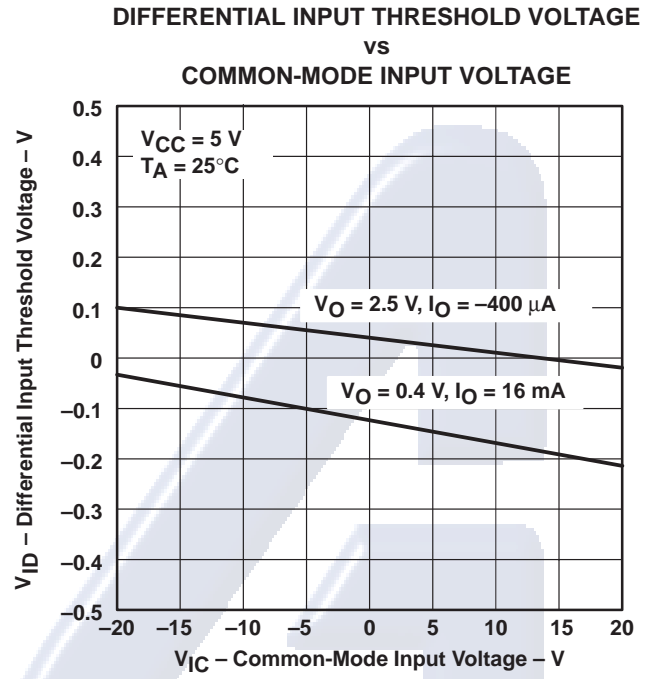
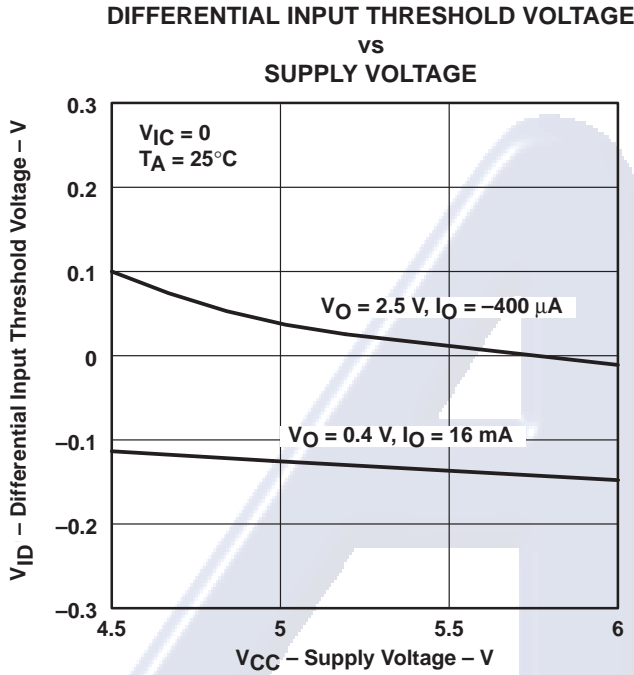

† Operation of the device at these or any other conditions beyond those indicated under "recommended operating conditions" is not implied.



SN55182, SN75182 DUAL DIFFERENTIAL LINE RECEIVERS

SLLS092D – OCTOBER 1972 – REVISED APRIL 1998

TYPICAL CHARACTERISTICS†

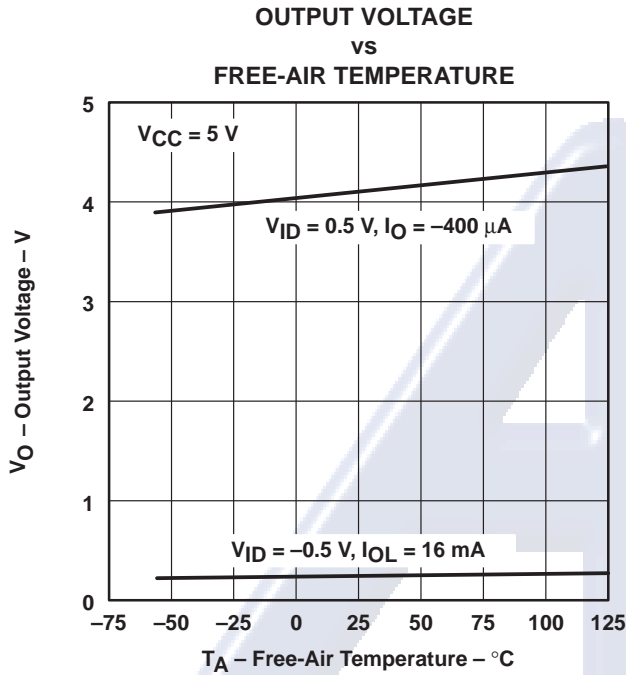

Figure 5

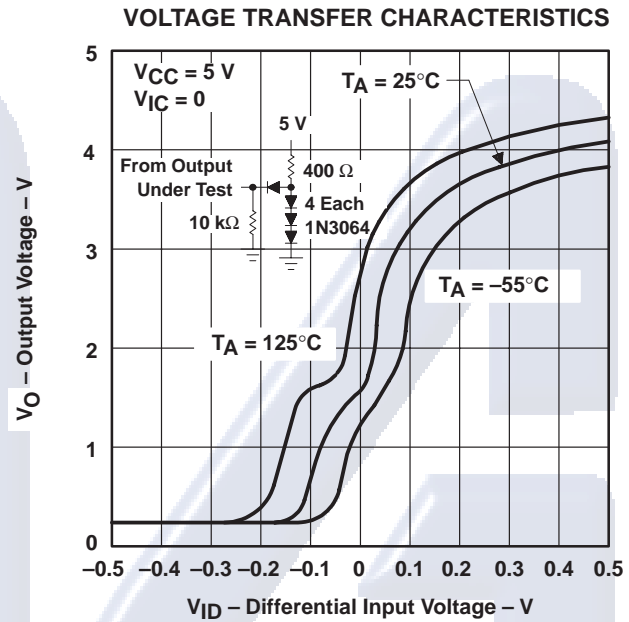

Figure 6

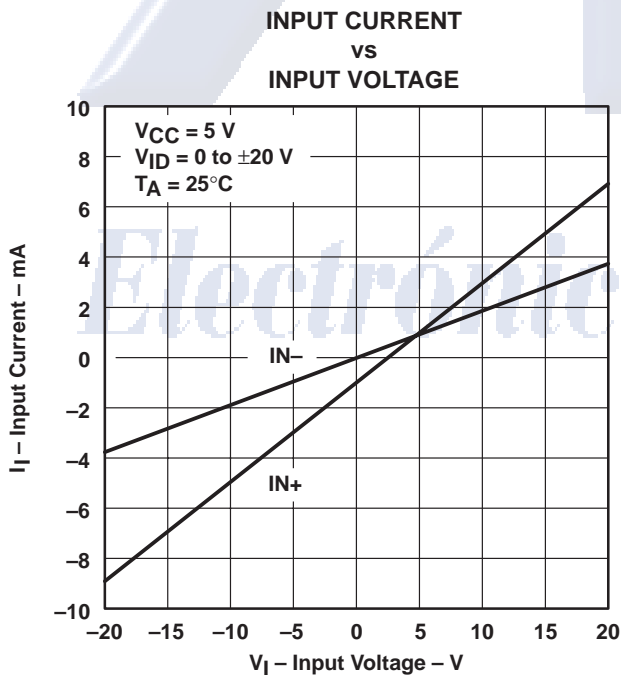

Figure 7

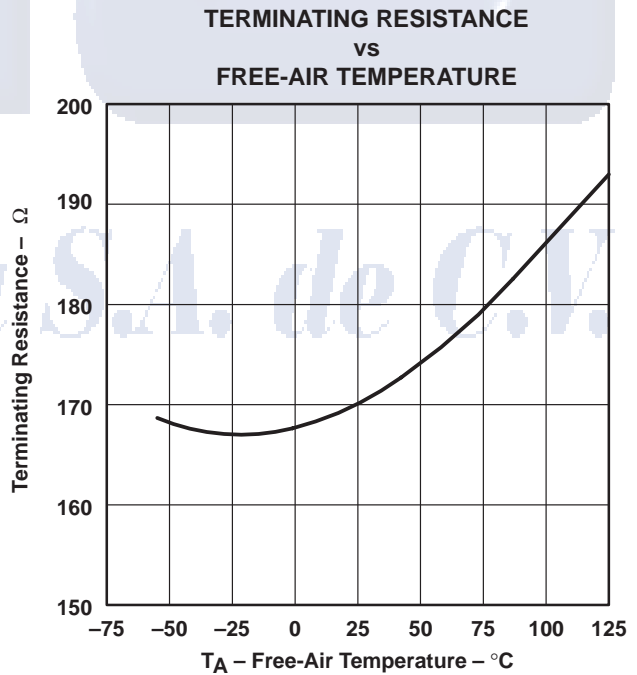

Figure 8

† Operation of the device at these or any other conditions beyond those indicated under "recommended operating conditions" is not implied.



POST OFFICE BOX 655303 • DALLAS, TEXAS 75265

SN55182, SN75182 DUAL DIFFERENTIAL LINE RECEIVERS

SLLS092D – OCTOBER 1972 – REVISED APRIL 1998

TYPICAL CHARACTERISTICS†

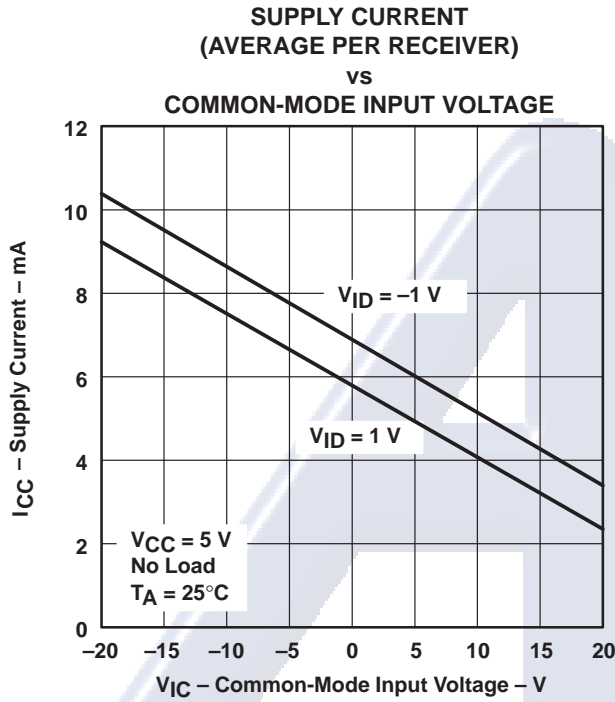

Figure 9

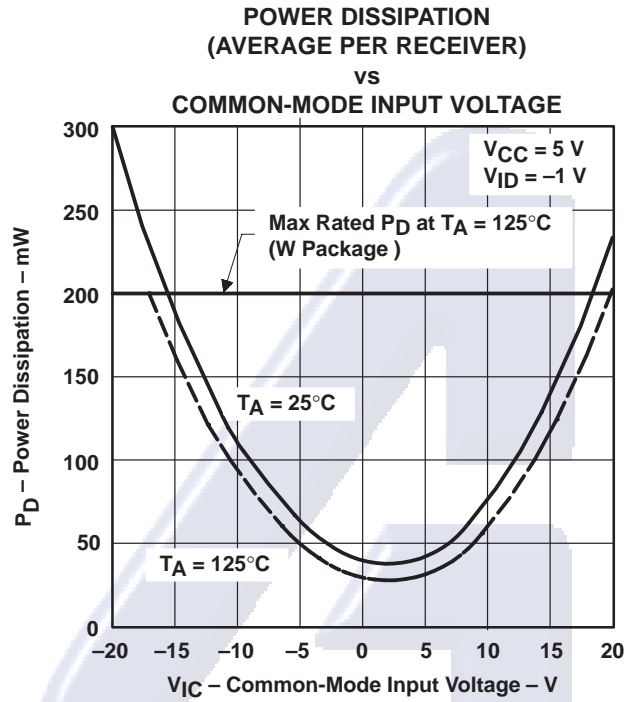

Figure 10

† Operation of the device at these or any other conditions beyond those indicated under "recommended operating conditions" is not implied.

Electrónica S.A. de C.V.



SN55182, SN75182 DUAL DIFFERENTIAL LINE RECEIVERS

SLLS092D – OCTOBER 1972 – REVISED APRIL 1998

TYPICAL CHARACTERISTICS†

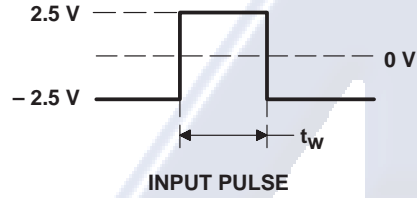
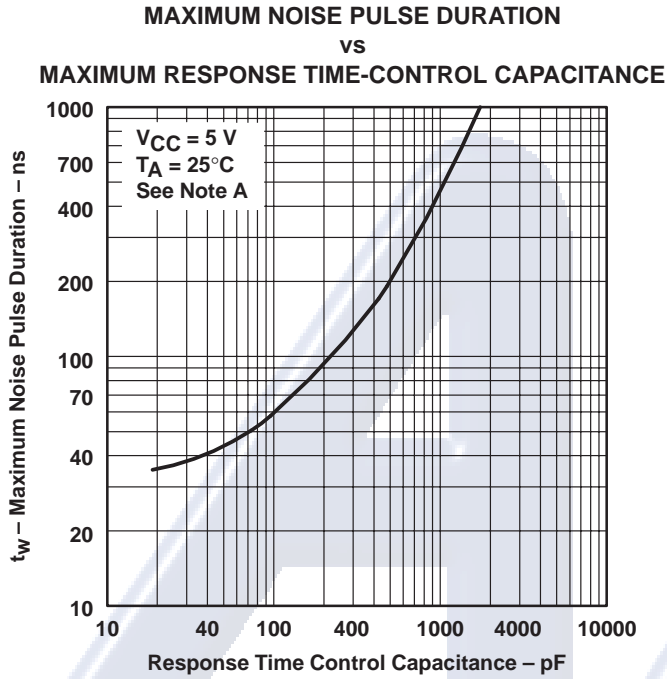

NOTE A: Figure 11 shows the maximum duration of the illustrated pulse that can be applied differently without the output changing from the low to high level.

Figure 11

† Operation of the device at these or any other conditions beyond those indicated under "recommended operating conditions" is not implied.

Electrónica S.A. de C.V.



POST OFFICE BOX 655303 • DALLAS, TEXAS 75265

SN55182, SN75182 DUAL DIFFERENTIAL LINE RECEIVERS

SLLS092D – OCTOBER 1972 – REVISED APRIL 1998

TYPICAL CHARACTERISTICS†

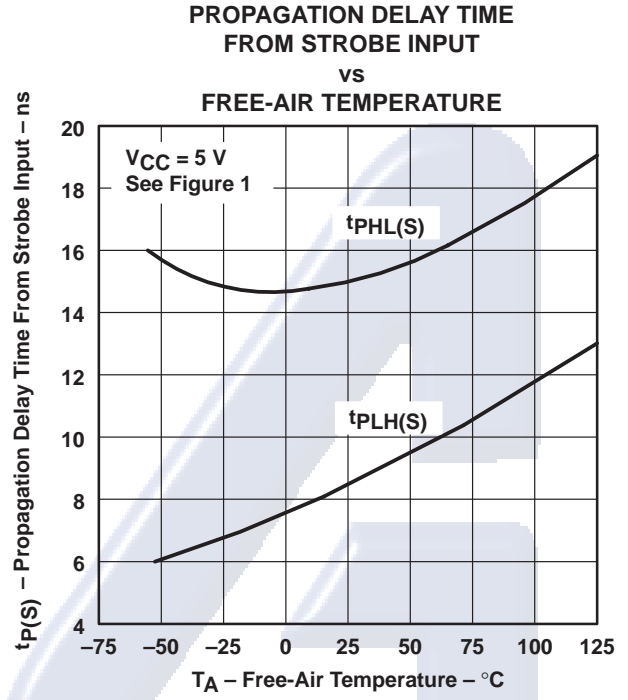
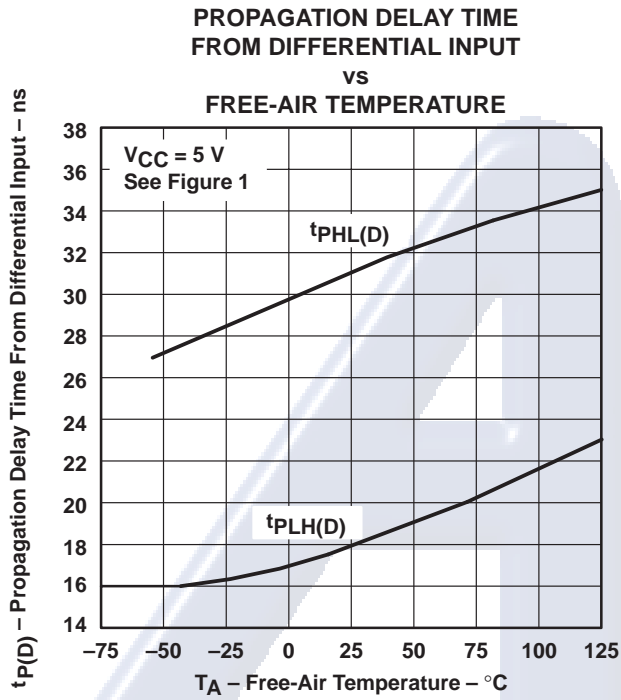

† Operation of the device at these or any other conditions beyond those indicated under "recommended operating conditions" is not implied.

Electrónica S.A. de C.V.



SN55182, SN75182 DUAL DIFFERENTIAL LINE RECEIVERS

SLLS092D – OCTOBER 1972 – REVISED APRIL 1998

APPLICATION INFORMATION

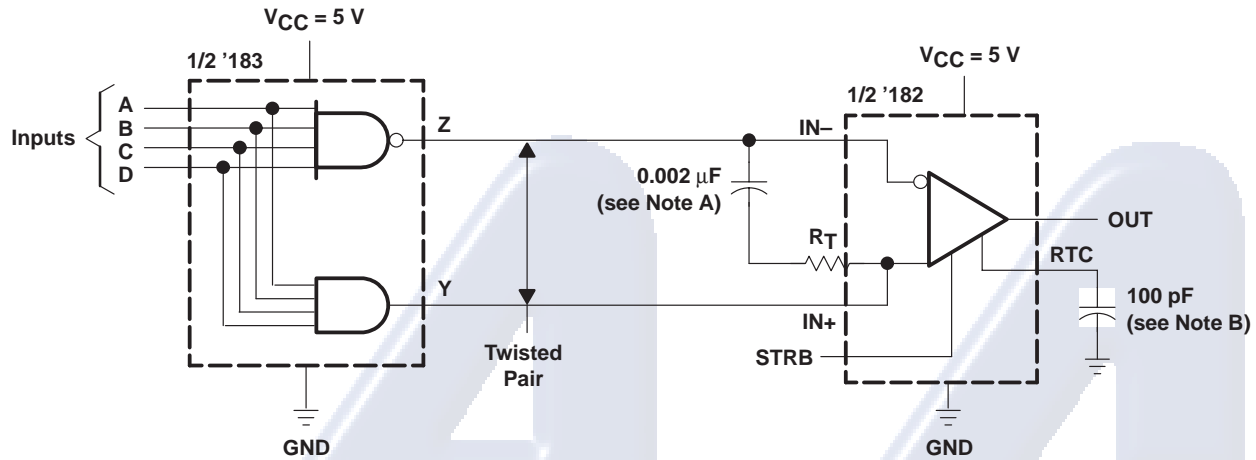

NOTES: A. When the inputs are open circuited, the output is high. A capacitor may be used for dc isolation of the line-terminating resistor. At the frequency of operation, the impedance of the capacitor should be relatively small.

Example: let $f = 5 \text{ MHz}$
 $C = 0.002 \mu\text{F}$

$$Z_{(C)} = \frac{1}{2\pi f C} = \frac{1}{2\pi(5 \times 10^6)(0.002 \times 10^{-6})}$$

$$Z_{(C)} \approx 16\Omega$$

B. Use of a capacitor to control response time is optional.

Figure 14. Transmission of Digital Data Over Twisted-Pair Line

Electrónica S.A. de C.V.

IMPORTANT NOTICE

Texas Instruments and its subsidiaries (TI) reserve the right to make changes to their products or to discontinue any product or service without notice, and advise customers to obtain the latest version of relevant information to verify, before placing orders, that information being relied on is current and complete. All products are sold subject to the terms and conditions of sale supplied at the time of order acknowledgement, including those pertaining to warranty, patent infringement, and limitation of liability.

TI warrants performance of its semiconductor products to the specifications applicable at the time of sale in accordance with TI's standard warranty. Testing and other quality control techniques are utilized to the extent TI deems necessary to support this warranty. Specific testing of all parameters of each device is not necessarily performed, except those mandated by government requirements.

CERTAIN APPLICATIONS USING SEMICONDUCTOR PRODUCTS MAY INVOLVE POTENTIAL RISKS OF DEATH, PERSONAL INJURY, OR SEVERE PROPERTY OR ENVIRONMENTAL DAMAGE ("CRITICAL APPLICATIONS"). TI SEMICONDUCTOR PRODUCTS ARE NOT DESIGNED, AUTHORIZED, OR WARRANTED TO BE SUITABLE FOR USE IN LIFE-SUPPORT DEVICES OR SYSTEMS OR OTHER CRITICAL APPLICATIONS. INCLUSION OF TI PRODUCTS IN SUCH APPLICATIONS IS UNDERSTOOD TO BE FULLY AT THE CUSTOMER'S RISK.

In order to minimize risks associated with the customer's applications, adequate design and operating safeguards must be provided by the customer to minimize inherent or procedural hazards.

TI assumes no liability for applications assistance or customer product design. TI does not warrant or represent that any license, either express or implied, is granted under any patent right, copyright, mask work right, or other intellectual property right of TI covering or relating to any combination, machine, or process in which such semiconductor products or services might be or are used. TI's publication of information regarding any third party's products or services does not constitute TI's approval, warranty or endorsement thereof.

Electrónica S.A. de C.V.
Copyright © 1998, Texas Instruments Incorporated