

TOSHIBA**TD62081~084AP/CP/F/AF**

TOSHIBA BIPOLAR DIGITAL INTEGRATED CIRCUIT SILICON MONOLITHIC
TD62081AP, TD62081CP, TD62081F, TD62081AF, TD62082AP, TD62082CP
TD62082F, TD62082AF, TD62083AP, TD62083CP, TD62083F, TD62083AF
TD62084AP, TD62084CP, TD62084F, TD62084AF

8CH DARLINGTON SINK DRIVER

The TD62081AP/CP/F/AF Series are high-voltage, high-current darlington drivers comprised of eight NPN darlington pairs.

All units feature integral clamp diodes for switching inductive loads.

Applications include relay, hammer, lamp and display (LED) drivers.

FEATURES

- Output current (single output)
500mA (Max.) (TD62081AP/F/AF series)
400mA (Max.) (TD62081CP series)
- High sustaining voltage output
35V (Min.) (TD62081F series)
50V (Min.) (TD62081AP/AF series)
100V (Min.) (TD62081CP series)
- Output clamp diodes
- Inputs compatible with various types of logic.
- Package type-AP, CP : DIP-18pin
- Package type-F, AF : SOP-18pin

TD62081AP/CP, TD62082AP/CP
 TD62083AP/CP, TD62084AP/CP

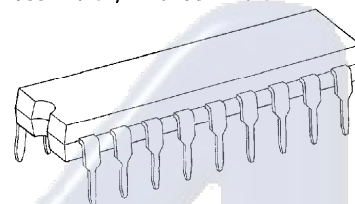

DIP18-P-300-2.54D

TD62081F/AF, TD62082F/AF
 TD62083F/AF, TD62084F/AF

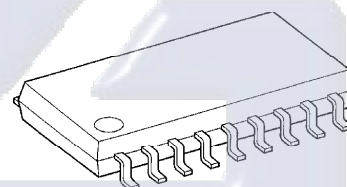

SOP18-P-375-1.27

Weight
 DIP18-P-300-2.54D : 1.478g (Typ.)
 SOP18-P-375-1.27 : 0.41g (Typ.)

TYPE	INPUT BASE RESISTOR	DESIGNATION
TD62081AP/CP/F/AF	External	General Purpose
TD62082AP/CP/F/AF	10.5-k Ω + 7V Zener diode	14~25V PMOS
TD62083AP/CP/F/AF	2.7k Ω	TTL, 5V CMOS
TD62084AP/CP/F/AF	10.5k Ω	6~15V PMOS, CMOS

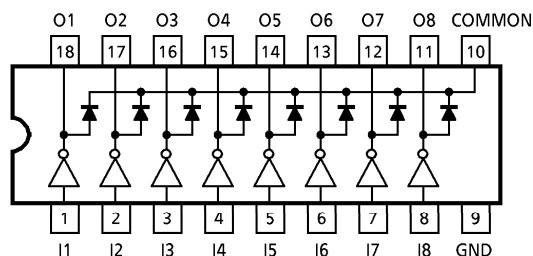
PIN CONNECTION (TOP VIEW)

961001EBA2

- TOSHIBA is continually working to improve the quality and the reliability of its products. Nevertheless, semiconductor devices in general can malfunction or fail due to their inherent electrical sensitivity and vulnerability to physical stress. It is the responsibility of the buyer, when utilizing TOSHIBA products, to observe standards of safety, and to avoid situations in which a malfunction or failure of a TOSHIBA product could cause loss of human life, bodily injury or damage to property. In developing your designs, please ensure that TOSHIBA products are used within specified operating ranges as set forth in the most recent products specifications. Also, please keep in mind the precautions and conditions set forth in the TOSHIBA Semiconductor Reliability Handbook.
- The products described in this document are subject to foreign exchange and foreign trade control laws.
- The information contained herein is presented only as a guide for the applications of our products. No responsibility is assumed by TOSHIBA CORPORATION for any infringements of intellectual property or other rights of the third parties which may result from its use. No license is granted by implication or otherwise under any intellectual property or other rights of TOSHIBA CORPORATION or others.
- The information contained herein is subject to change without notice.

1998-05-15 1/10

TOSHIBA**TD62081~084AP/CP/F/AF****SCHEMATICS (EACH DRIVER)**

TD62081AP / CP / F / AF

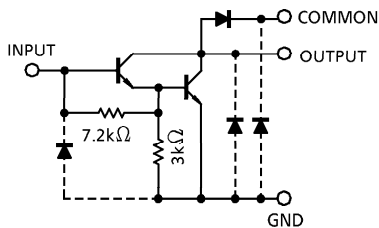

TD62082AP / CP / F / AF

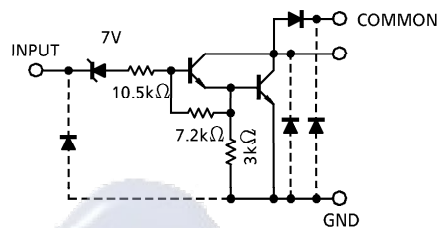

TD62083AP / CP / F / AF

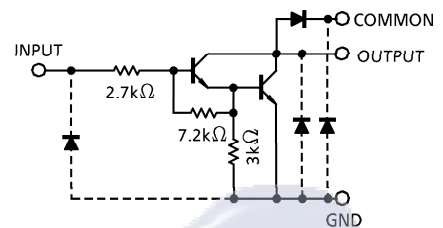

TD62084AP / CP / F / AF

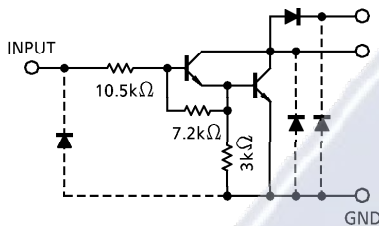

(Note) The input and output parasitic diodes cannot be used as clamp diodes.

MAXIMUM RATINGS (Ta = 25°C)

CHARACTERISTIC	SYMBOL	RATING	UNIT
Output Sustaining Voltage	V _{CE (SUS)}	-0.5~50	V
		-0.5~100	
		-0.5~35	
Output Current	I _{OUT}	500	mA / ch
		400	
Input Voltage	V _{IN} (Note 1)	-0.5~30	V
Input Current	I _{IN} (Note 2)	25	mA
Clamp Diode Reverse Voltage	V _R	50	V
		100	
		35	
Clamp Diode Forward Current	I _F	500	mA
		400	
Power Dissipation	P _D	1.47	W
		0.96	
Operating Temperature	T _{opr}	-40~85	°C
Storage Temperature	T _{stg}	-55~150	°C

(Note 1) Except TD62081AP/CP/F/AF

(Note 2) Only TD62081AP/CP/F/AF

TOSHIBA**TD62081~084AP/CP/F/AF****RECOMMENDED OPERATING CONDITIONS (Ta = -40~85°C)**

CHARACTERISTIC		SYMBOL	TEST CONDITION	MIN.	TYP.	MAX.	UNIT
Output Sustaining Voltage	AP, AF	V _{CE (SUS)}		0	—	50	V
	CP			0	—	100	
	F			0	—	35	
Output Current	AP, CP	I _{OUT}	T _{pw} = 25ms, Duty = 10%, 8 Circuits	0	—	347	mA / ch
			T _{pw} = 25ms, Duty = 50%, 8 Circuits	0	—	123	
	F, AF		T _{pw} = 25ms, Duty = 10%, 8 Circuits	0	—	268	
			T _{pw} = 25ms, Duty = 50%, 8 Circuits	0	—	90	
Input Voltage	Except TD62081AP / CP / F / AF	V _{IN}		0	—	30	V
Input Voltage (Output On)	TD62082AP / CP / F / AF	V _{IN (ON)}		14	—	30	V
	TD62083AP / CP / F / AF			3.5	—	30	
	TD62084AP / CP / F / AF			8	—	30	
Input Current	Only TD62081AP / CP / F / AF	I _{IN}		0	—	5	mA
Clamp Diode Reverse Voltage	AP, AF	V _R		—	—	50	V
	CP			—	—	100	
	F			—	—	35	
Clamp Diode Forward Current	CP	I _F		—	—	400	mA
				—	—	320	
Power Dissipation	AP, CP	P _D		—	—	0.52	W
	F, AF			—	—	0.4	

TOSHIBA**TD62081~084AP/CP/F/AF****ELECTRICAL CHARACTERISTICS (Ta = 25°C)**

CHARACTERISTIC		SYMBOL	TEST CIRCUIT	TEST CONDITION	MIN.	TYP.	MAX.	UNIT				
Output Leakage Current	AP, AF CP F	ICEX	1	VCE = 50V	Ta = 25°C	—	—	50				
				VCE = 100V								
				VCE = 35V								
	AP, AF CP F			—	—	—	—	—	—	100		
											VCE = 50V	
											VCE = 100V	
	TD62082			AP, AF CP F	—	—	—	VIN = 6V	—	—	500	
												VCE = 100V
												VCE = 35V
	TD62084			AP, AF CP F	—	—	—	VIN = 1V	—	—	500	
												VCE = 50V
												VCE = 100V
				VCE = 35V								
Collector-Emitter Saturation Voltage		VCE (sat)	2	IOUT = 350mA, IIN = 500μA IOUT = 200mA, IIN = 350μA IOUT = 100mA, IIN = 250μA	—	1.3	1.6	V				
Input Current	TD62082AP / CP / F / AF TD62083AP / CP / F / AF TD62084AP / CP / F / AF	IIN (ON)	2	VIN = 17V	—	0.82	1.25	mA				
				VIN = 3.85V	—	0.93	1.35					
				VIN = 5V	—	0.35	0.5					
				VIN = 12V	—	1.0	1.45					
			IIN (OFF)	4	IOUT = 500μA, Ta = 85°C	50	65	—	μA			
Input Voltage (Output On)	TD62082AP / CP / F / AF TD62083AP / CP / F / AF	VIN (ON)	5	VCE = 2V, IOUT = 300mA	—	—	13	V				
				VCE = 2V, IOUT = 200mA	—	—	2.4					
	VCE = 2V, IOUT = 250mA			—	—	2.7						
	VCE = 2V, IOUT = 300mA			—	—	3.0						
	VCE = 2V, IOUT = 125mA			—	—	5.0						
	VCE = 2V, IOUT = 200mA			—	—	6.0						
	VCE = 2V, IOUT = 275mA			—	—	7.0						
	VCE = 2V, IOUT = 350mA			—	—	8.0						
DC Current Transfer Ratio		hFE	2	VCE = 2V, IOUT = 350mA	1000	—	—					
Clamp Diode Reverse Current		IR	6	Ta = 25°C (Note) Ta = 85°C (Note)	—	—	50 100	μA				
Clamp Diode Forward Voltage	CP	VF	7	IF = 350mA	—	—	2.0	V				
				IF = 280mA	—	—	1.8					
Input Capacitance		CIN	—		—	15	—	pF				

(Note) VR = VR MAX.

CHARACTERISTIC		SYMBOL	TEST CIRCUIT	TEST CONDITION	MIN.	TYP.	MAX.	UNIT
Turn-On Delay	AP, AF	t_{ON}	8	$R_L = 125\Omega, V_{OUT} = 50V$	—	0.1	—	μs
	CP			$R_L = 312\Omega, V_{OUT} = 100V$	—	0.1	—	
	F			$R_L = 87.5\Omega, V_{OUT} = 35V$	—	0.1	—	
Turn-Off Delay	AP, AF	t_{OFF}		$R_L = 125\Omega, V_{OUT} = 50V$	—	0.2	—	
	CP			$R_L = 312\Omega, V_{OUT} = 100V$	—	3.0	—	
	F			$R_L = 87.5\Omega, V_{OUT} = 35V$	—	0.2	—	

TEST CIRCUIT

1. I_{CEX}

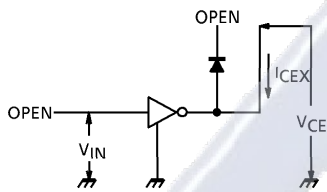

2. $V_{CE(sat)}, h_{FE}$

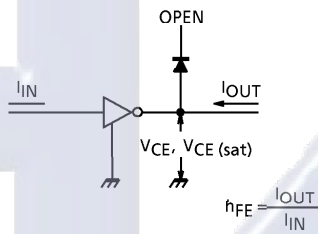

3. $I_{IN(ON)}$

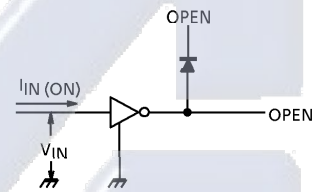

4. $I_{IN(OFF)}$

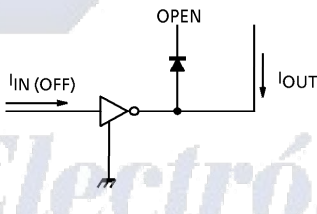

5. $V_{IN(ON)}$

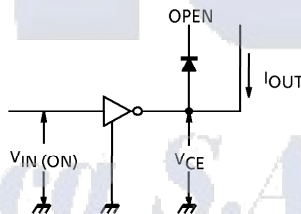

6. I_R

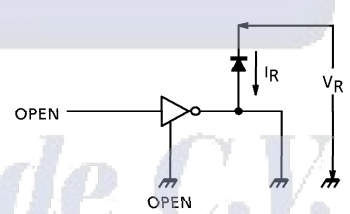

7. V_F

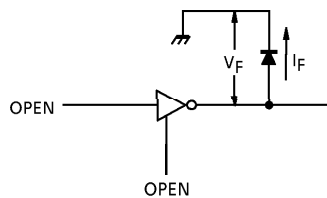

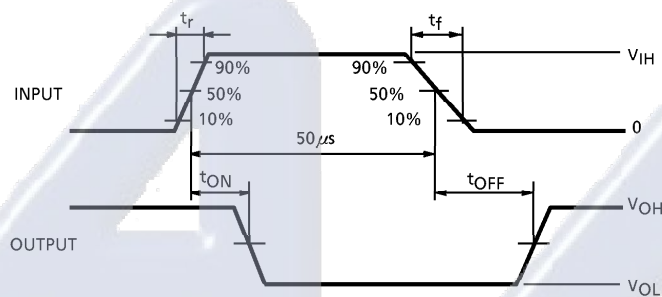
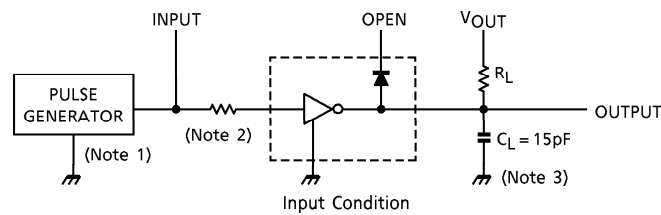
8. t_{ON} , t_{OFF} 

- (Note 1) Pulse Width $50\mu\text{s}$, Duty Cycle 10%
Output Impedance 50Ω , $t_r \leq 5\text{ns}$, $t_f \leq 10\text{ns}$
- (Note 2) See below.

INPUT CONDITION

TYPE NUMBER	R1	V_{IH}
TD62081AP/CP/F/AF	$2.7\text{k}\Omega$	3V
TD62082AP/CP/F/AF	0Ω	13V
TD62083AP/CP/F/AF	0Ω	3V
TD62084AP/CP/F/AF	0Ω	8V

- (Note 3) C_L includes probe and jig capacitance

PRECAUTIONS for USING

Utmost care is necessary in the design of the output line, COMMON and GND line since IC may be destroyed due to short-circuit between outputs, air contamination fault, or fault by improper grounding.

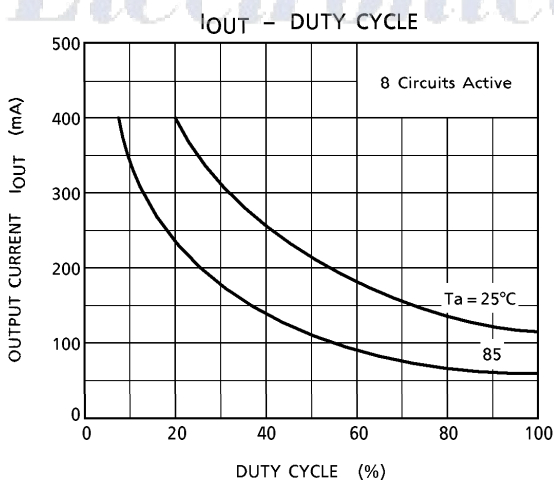
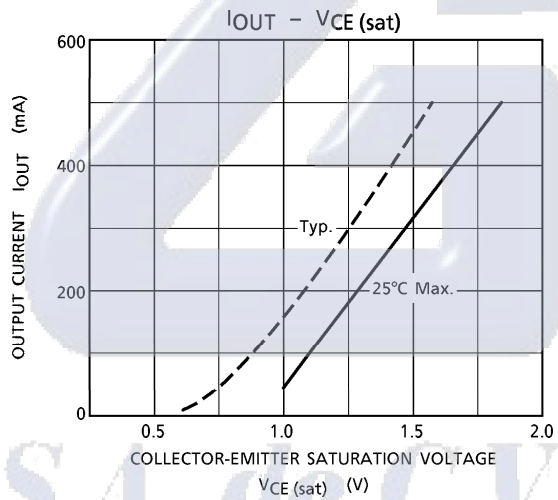
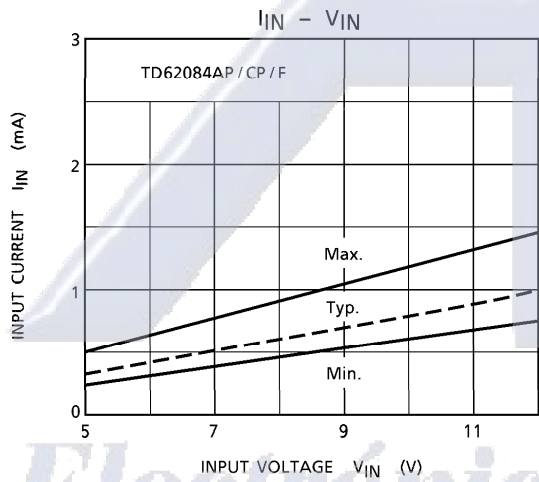
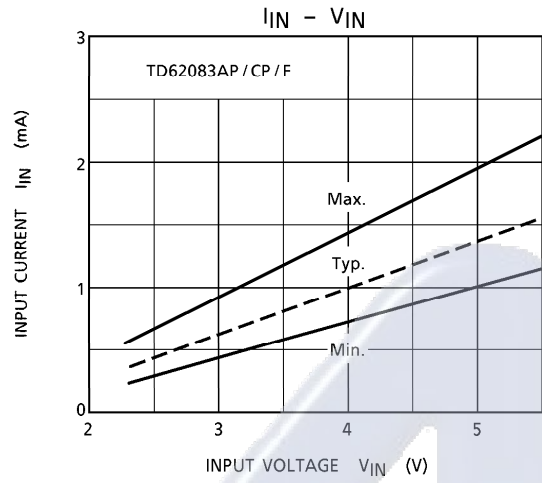
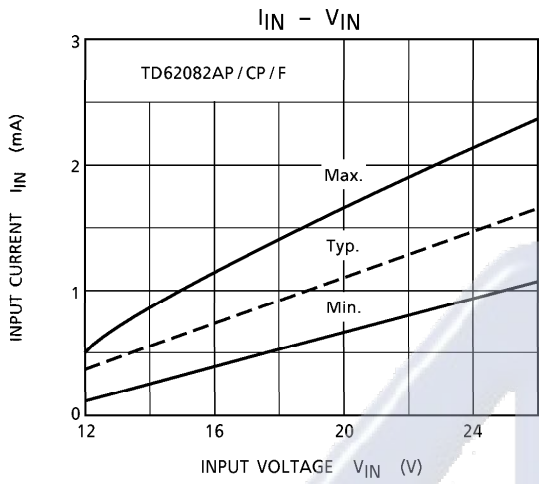

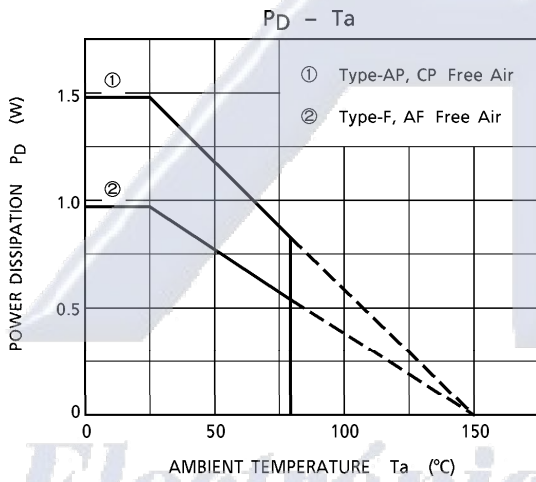
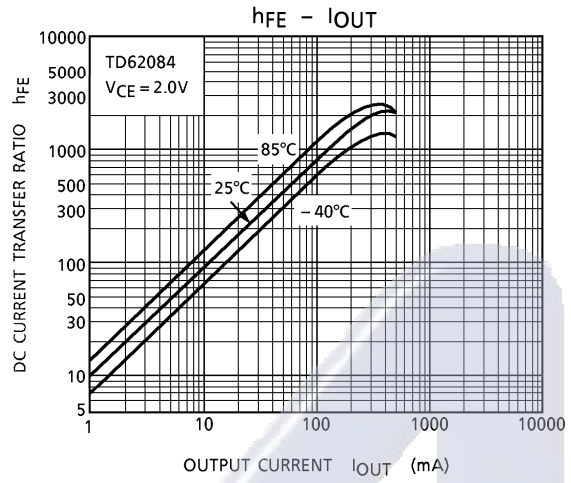
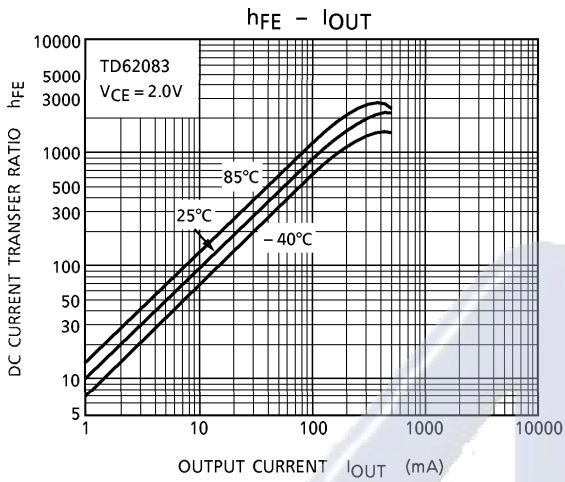

Electrónica S.A. de C.V.

TOSHIBA

TD62081~084AP/CP/F/AF

OUTLINE DRAWING
DIP18-P-300-2.54D

Unit : mm

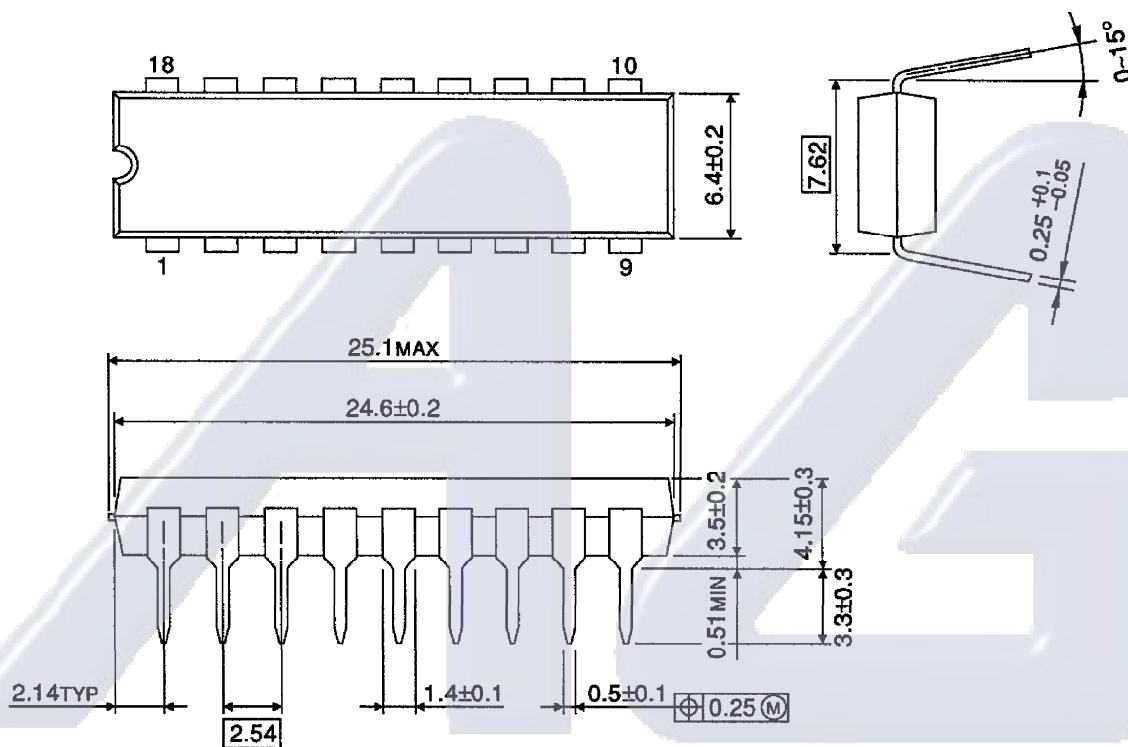

Electrónica S.A. de C.V.

Weight : 1.478g (Typ.)

OUTLINE DRAWING
SOP18-P-375-1.27

Unit : mm

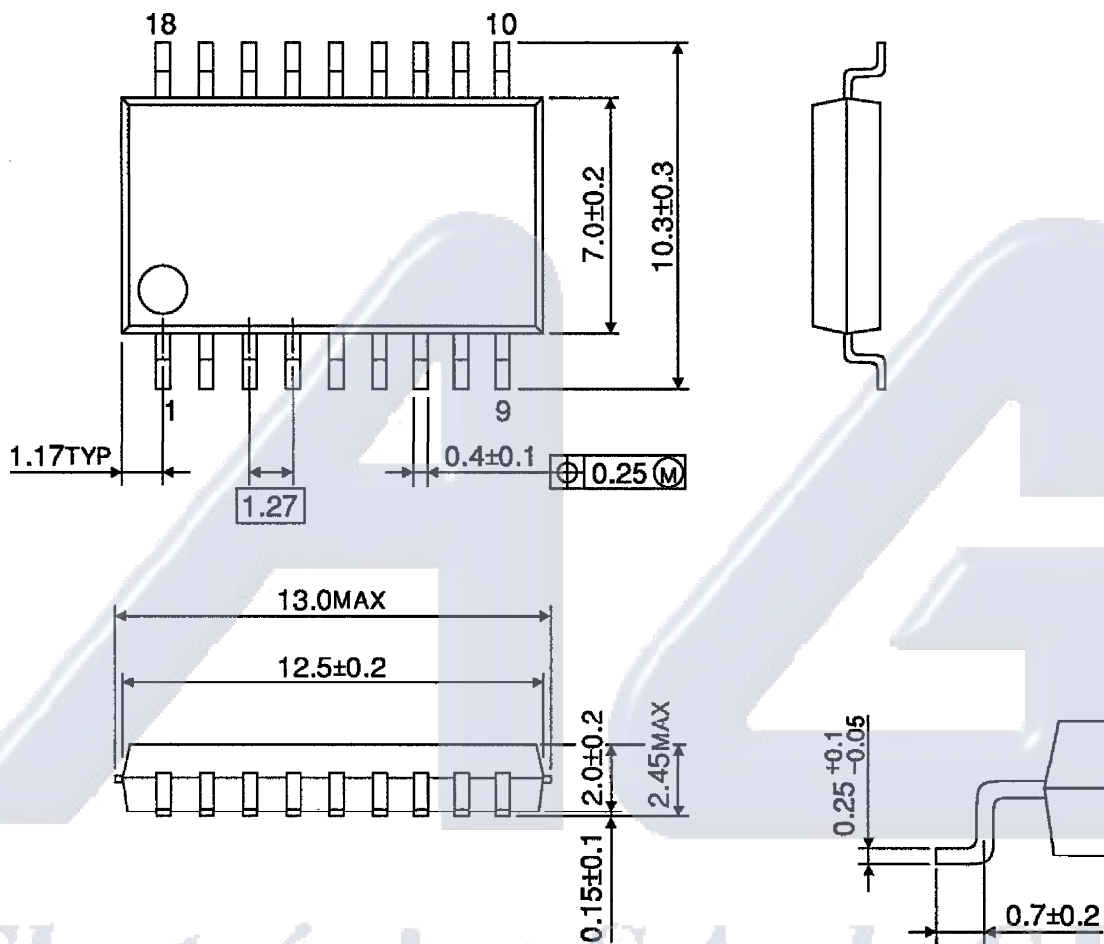

Weight : 0.41g (Typ.)

Electrónica S.A. de C.V.