

One Chip AM/FM Radio with Audio Power Amplifier

Description

The integrated circuit TDA1083 includes, with exception of the FM front end, a complete AM-/FM-radio-circuit with audio power amplifier. An internal Z-diode

stabilizes the supply voltage at $V_S \approx 13$ V, which allows with the aid of a resistor and a rectifier, the circuit to be driven by a higher external supply voltage.

Features

- Large supply voltage range $V_S = 3$ to 12 V
- High AM-Sensitivity
- Limiting threshold voltage $V_i = 50 \mu\text{V}$
- Audio output power $P_0 = 0.7$ W

- AFC-connection for VHF-tuner
- AM-FM switching without high frequency voltages

Applications

- AM-/FM- and audio-amplifier

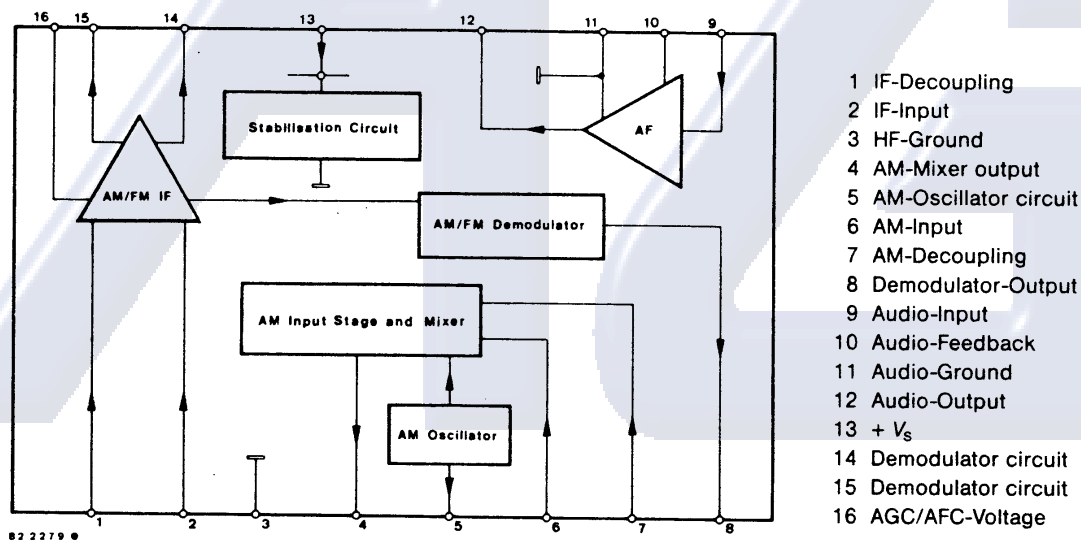

Figure 1. Block diagram and pin connections

Absolute Maximum Ratings

Reference points Pin 3 and 11, unless otherwise specified

Parameters	Symbol	Value	Unit
Supply voltage range Pin 13	V_S	3 to 12	V
Supply current when using the integrated stabilization circuit, $V_S = 12.5$ to 14.3 V Pin 13	I_S	50	mA
Power dissipation $T_{amb} = 65^\circ\text{C}$	P_{tot}	600	mW
Junction temperature	T_j	125	$^\circ\text{C}$
Storage temperature range	T_{stg}	-25 to +125	$^\circ\text{C}$

Thermal Resistance

Parameters	Symbol	Maximum	Unit
Junction ambient	R_{thJA}	100	K/W

TDA1083

Electrical Characteristics

$V_S = 9\text{ V}$, reference points Pin 3 and 11, $T_{amb} = 25^\circ\text{C}$, unless otherwise specified

Parameters	Test Conditions / Pin	Symbol	Min	Typ	Max	Unit	
AF amplifier							
AF voltage amplification	$f = 1\text{ kHz}$	G_v		40		dB	
Input impedance		R_i		150		$k\Omega$	
Output power	Figures 4 and 5 $V_S = 5.5\text{ V}$, $R_L = 8\ \Omega$, $k = 10\%$	P_o	300			mW	
AM-IF amplifier, $f_i = 1\text{ MHz}$, $f_{IF} = 455\text{ kHz}$, $f_{mod} = 1\text{ kHz}$, $m = 0.3$							
DC voltages at AM mode without signal	$V_S = 3\text{ V}$	Pin 10	V_{10}		1.2		V
		Pin 12	V_{12}	1.0		1.4	V
		Pin 13	V_{13}	3.0	3.0	3.0	V
		Pin 16	V_{16}	1.25		2.0	V
	$I_S = 42\text{ mA}$ ($V_S = 12.5\text{ to }14.3\text{ V}$)	Pin 10	V_{10}		1.2		V
		Pin 12	V_{12}	5.9		7.2	V
		Pin 13	V_{13}	12.5	13.3	14.3	V
		Pin 16	V_{16}	1.5		2.0	V
Regulation range	$V_{oAF}/V_{oAF} = -10\text{ dB}$						
	Pin 6	ΔV_i		70		dB	
AF voltage at demodulator output		Pin 8	V_{oAF}		100	mV	
FM-IF amplifier, $f_{IF} = 10.7\text{ MHz}$, $\Delta f = \pm 22.5\text{ kHz}$, $f_{mod} = 1\text{ kHz}$							
DC voltages at FM mode without signal	$V_S = 3\text{ V}$	Pin 10	V_{10}		1.2		V
		Pin 12	V_{12}	1.0		1.4	V
		Pin 13	V_{13}	3.0	3.0	3.0	V
		Pin 16	V_{16}	1.8		2.8	V
	$I_S = 42\text{ mA}$ ($V_S = 12.5\text{ to }14.3\text{ V}$)	Pin 10	V_{10}		1.2		V
		Pin 12	V_{12}	5.9		7.2	V
		Pin 13	V_{13}	12.5	13.3	14.3	V
		Pin 16	V_{16}	2.0		3.1	V
Limiting threshold (-3 dB)		Pin 2	V_i		50	μV	
AF voltage at demodulator output		Pin 8	V_{oAF}		100	mV	

Different dc voltages are developed at Pin 16 due to gain spread of AM-IF-amplifier. To determine the value of parallel resistance R_8 , at the output of the demodulator Pin 8 for $V_S = 9$ V, AM mode without signal, dc voltage should be selected at Pin 16.

Table 1. Available in following voltage groups:

V_{16}	1.4 to 1.7 V	1.7 to 1.9 V	1.9 to 2.1 V
R_8	∞	47 k Ω	33 k Ω
Group	1	2	3

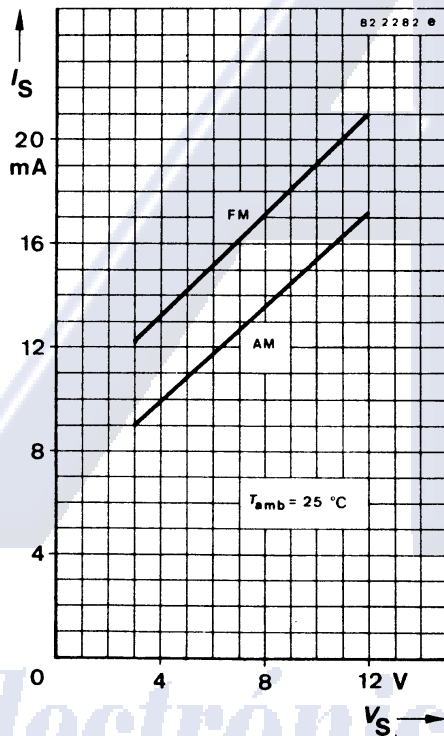

Figure 2.

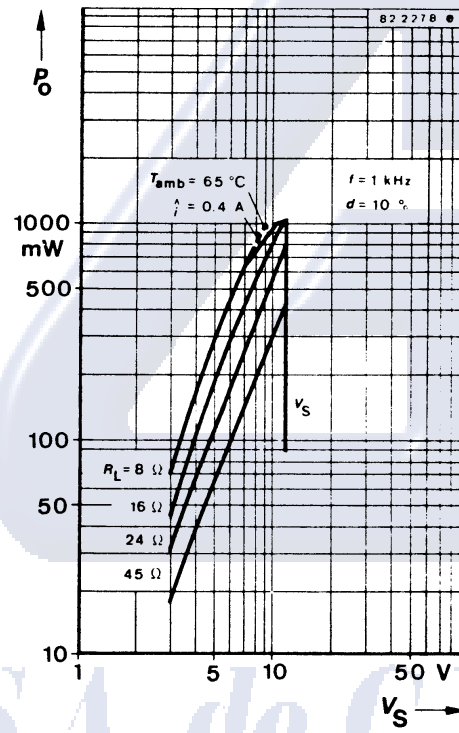

Figure 3.

TDA1083

TEMIC
Semiconductors

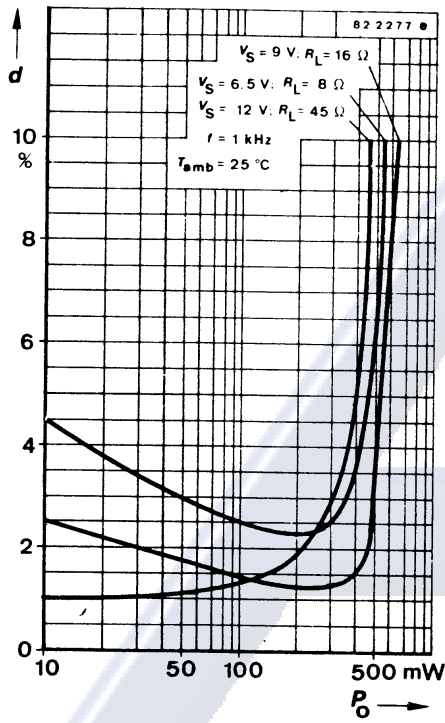

Figure 4.

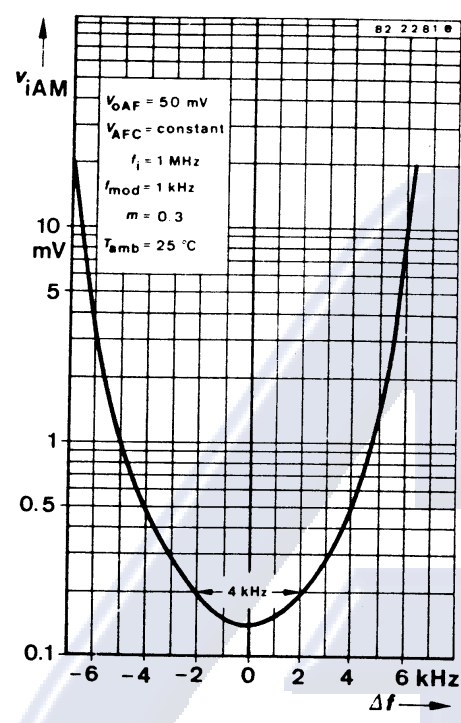

Figure 5.

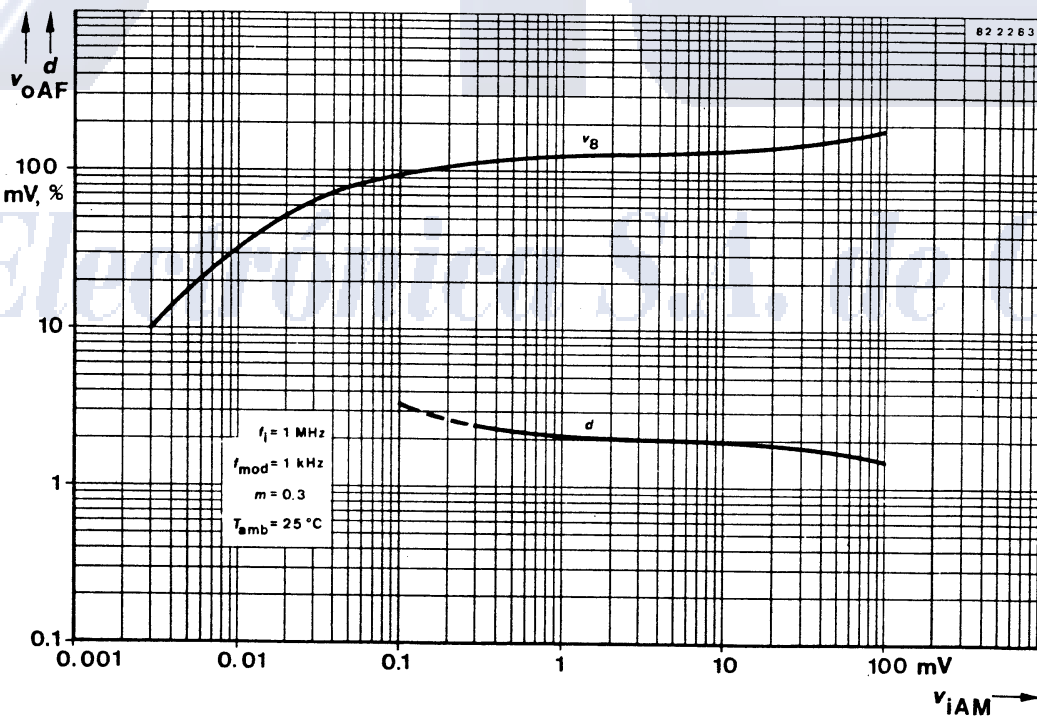

Figure 6.

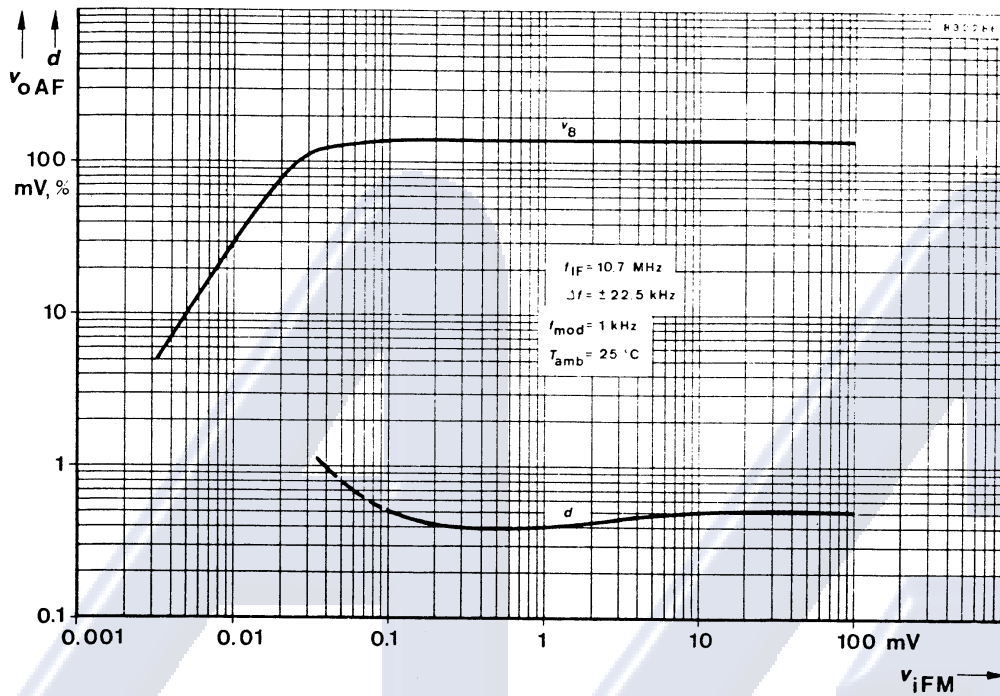

Figure 7.

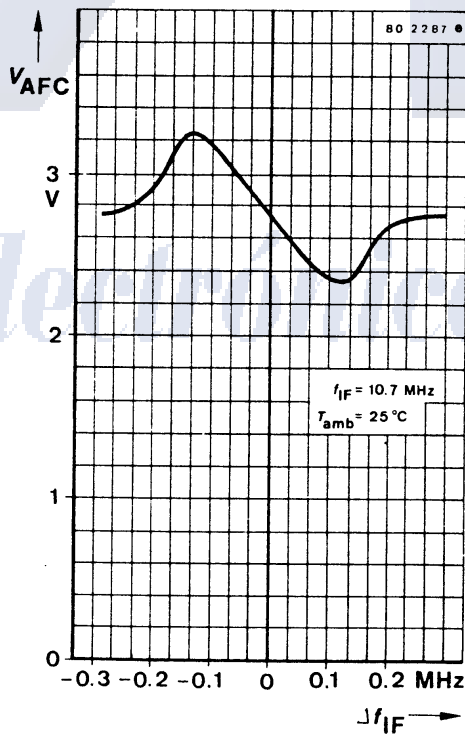

Figure 8.

TDA1083

Components in Figure 9

L ₁	=	4	Wdg Ø 0.45 CuL, threaded core 7.5x3 material: Fi 01 U8 (Vogt GmbH)
L ₂	=	5	Wdg Ø 0.45 CuL
L ₃	=	5	Wdg Ø 0.45 CuL, air core Ø 3.5 mm
L ₄	=	3+3	Wdg Ø 0.45 CuL, air core Ø 2.7 mm
L ₅	=	12	Wdg Ø 0.25 CuL, Pin 3-1, filter kit 154 AN(C) or 154ANS-7 A6363A0 (TOKO, Componex)
L ₆	=	2	Wdg Ø 0.25 CuL, Pin 4-6
L ₇	=	7	Wdg Ø 0.25 CuL, Pin 6-3, filter kit 154AN(C) or 154EES-7 A6392FA (TOKO, Componex)
L ₈	=	7	Wdg Ø 0.16 CuL, Pin 1-4, filter kit 154AN(C) or 154EES-7 A6391ABM (TOKO, Componex)
L ₉	=	5	Wdg Ø 0.16 CuL, Pin 2-6
L ₁₀	=	96	Wdg Ø 0.25 CuLs, ferrite aerial Ø 8x130 mm, type 031039-2103-606, (Draloric)
L ₁₁	=	6	Wdg Ø 0.25 CuLs
L ₁₂	=	78	Wdg Ø 0.09 CuL, Pin 3-4, filter kit RBR or RWOS-6A7609AAU (TOKO, Componex)
L ₁₃	=	7	Wdg Ø 0.09 CuL, Pin 2-1
L ₁₄	=	18	Wdg Ø 0.09 CuL, Pin 3-4, filter kit RHN(C) or RHCS-1A7607AQH (TOKO, Componex)
L ₁₅	=	46+100	Wdg Ø 0.09 CuL, Pin 6-2-1
L ₁₆	=	72+72	Wdg Ø 0.09 CuL Pin 3-4/6-1, filter kit RHN(C) or RHNS-1A7608AZP (TOKO, Componex)
455 kHz	=		Ceramic filter LBF 6 (Componex) or CFU 445 H (Stettner)
10.7 MHz	=		Ceramic filter 10.7 MF-18 (Componex) or SFE 10.7 MA (Stettner)
D _{r1} , D _{r3}	=		Ferrit bead on the transistor terminal
D _{r2}	=	16	Wdg Ø 0.25 CuL, Ø 2 air core
D _{r4}	=	6	Wdg Ø 0.15 CuL, Ø 2.1x3 mm ferrit bead
C ₆ =C ₁₄	=		4.5 to 20 pF, variable capacitor type CY2-22124-RT02 (TOKO, Componex)
C ₁₉	=		5 to 80 pF
C ₂₁	=		5 to 140 pF
R ₈	=		According to gain groups ∞, 47 kΩ or 33 kΩ

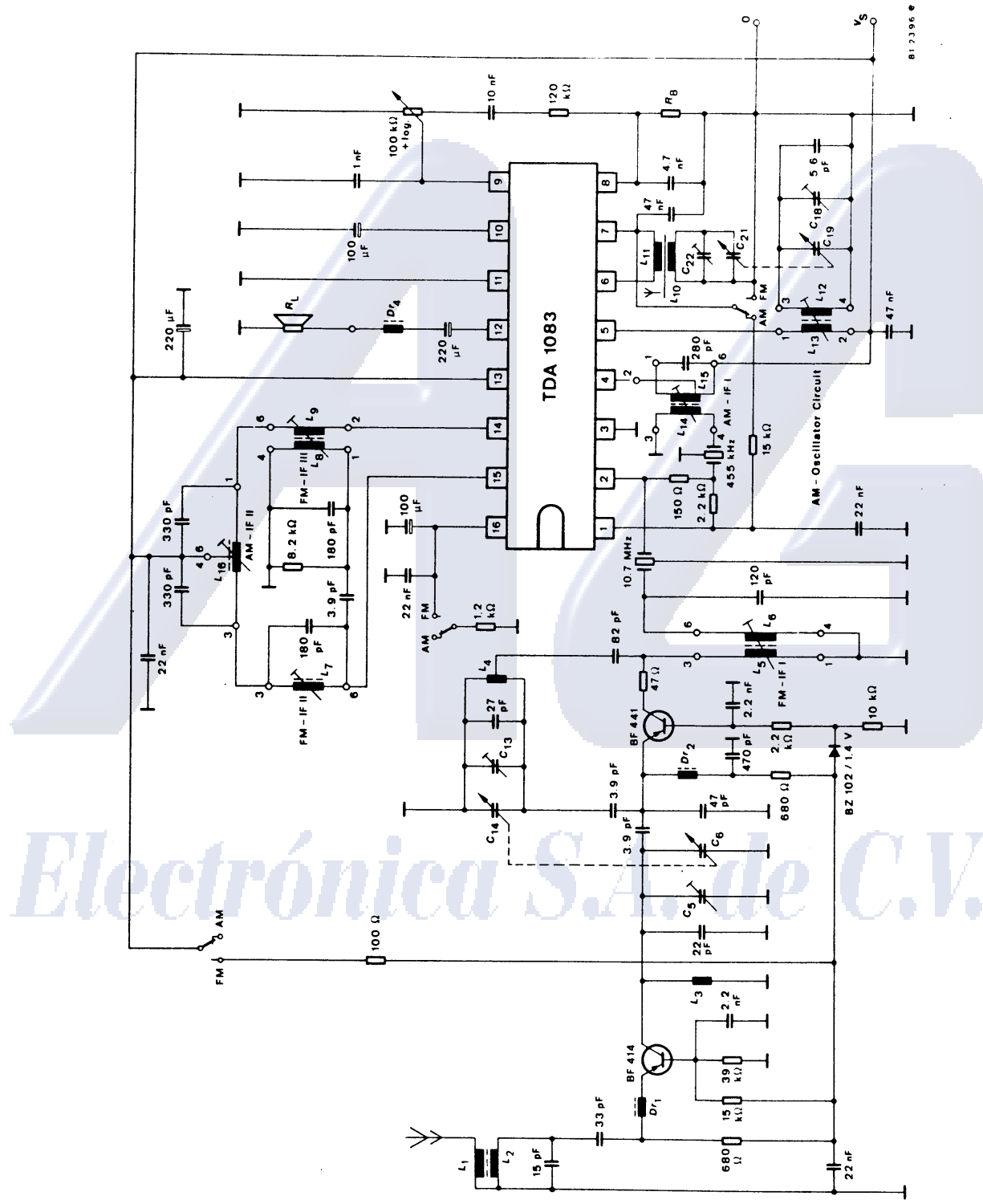

Figure 9. FM-/AM-receiver circuit

TDA1083

TEMIC
Semiconductors

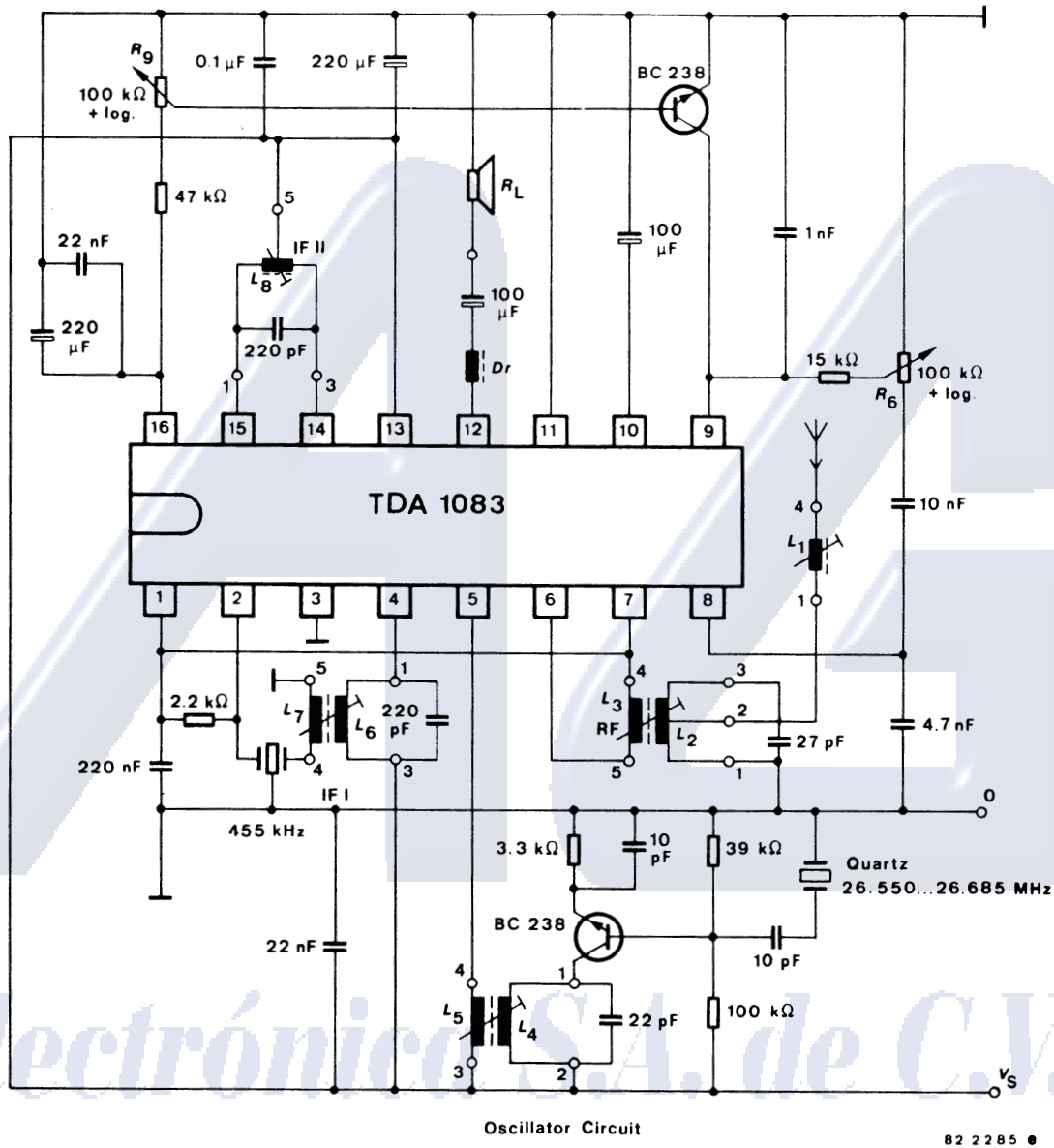
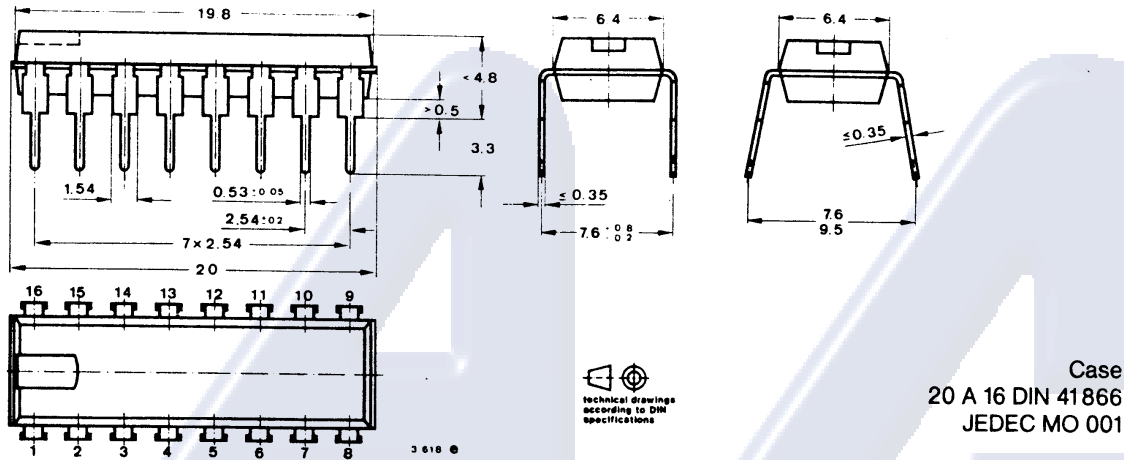

Figure 10.

Dimensions in mm



Electrónica S.A. de C.V.

TDA1083

TEMIC
Semiconductors

Ozone Depleting Substances Policy Statement

It is the policy of **TEMIC TELEFUNKEN microelectronic GmbH** to

1. Meet all present and future national and international statutory requirements.
2. Regularly and continuously improve the performance of our products, processes, distribution and operating systems with respect to their impact on the health and safety of our employees and the public, as well as their impact on the environment.

It is particular concern to control or eliminate releases of those substances into the atmosphere which are known as ozone depleting substances (ODSs).

The Montreal Protocol (1987) and its London Amendments (1990) intend to severely restrict the use of ODSs and forbid their use within the next ten years. Various national and international initiatives are pressing for an earlier ban on these substances.

TEMIC TELEFUNKEN microelectronic GmbH semiconductor division has been able to use its policy of continuous improvements to eliminate the use of ODSs listed in the following documents.

1. Annex A, B and list of transitional substances of the Montreal Protocol and the London Amendments respectively
2. Class I and II ozone depleting substances in the Clean Air Act Amendments of 1990 by the Environmental Protection Agency (EPA) in the USA
3. Council Decision 88/540/EEC and 91/690/EEC Annex A, B and C (transitional substances) respectively.

TEMIC can certify that our semiconductors are not manufactured with ozone depleting substances and do not contain such substances.

Electrónica S.A. de C.V.

We reserve the right to make changes to improve technical design and may do so without further notice.

Parameters can vary in different applications. All operating parameters must be validated for each customer application by the customer. Should the buyer use TEMIC products for any unintended or unauthorized application, the buyer shall indemnify TEMIC against all claims, costs, damages, and expenses, arising out of, directly or indirectly, any claim of personal damage, injury or death associated with such unintended or unauthorized use.

TEMIC TELEFUNKEN microelectronic GmbH, P.O.B. 3535, D-74025 Heilbronn, Germany
Telephone: 49 (0)7131 67 2831, Fax number: 49 (0)7131 67 2423