

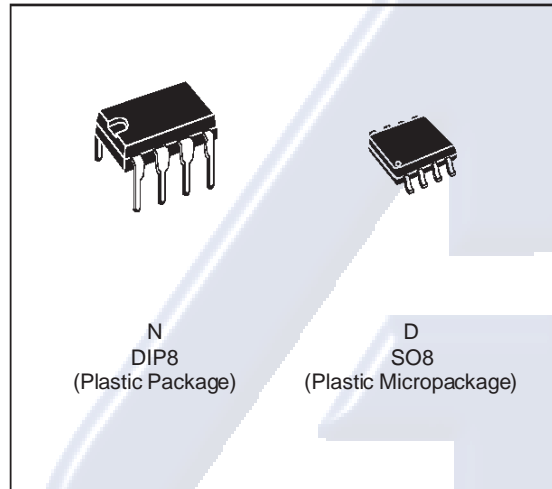

TL081 TL081A - TL081B

GENERAL PURPOSE J-FET SINGLE OPERATIONAL AMPLIFIER

- WIDE COMMON-MODE (UP TO V_{CC}^+) AND DIFFERENTIAL VOLTAGE RANGE
- LOW INPUT BIAS AND OFFSET CURRENT
- OUTPUT SHORT-CIRCUIT PROTECTION
- HIGH INPUT IMPEDANCE J-FET INPUT STAGE
- INTERNAL FREQUENCY COMPENSATION
- LATCH UP FREE OPERATION
- HIGH SLEW RATE : $16V/\mu s$ (typ)



N
DIP8
(Plastic Package)

D
SO8
(Plastic Micropackage)

DESCRIPTION

The TL081, TL081A and TL081B are high speed J-FET input single operational amplifiers incorporating well matched, high voltage J-FET and bipolar transistors in a monolithic integrated circuit.

The devices feature high slew rates, low input bias and offset currents, and low offset voltage temperature coefficient.

ORDER CODES

Part Number	Temperature Range	Package	
		N	D
TL081M/AM/BM	-55°C, +125°C	•	•
TL081I/AI/BI	-40°C, +105°C	•	•
TL081C/AC/BC	0°C, +70°C	•	•

Examples : TL081CD, TL081IN

PIN CONNECTIONS (top view)

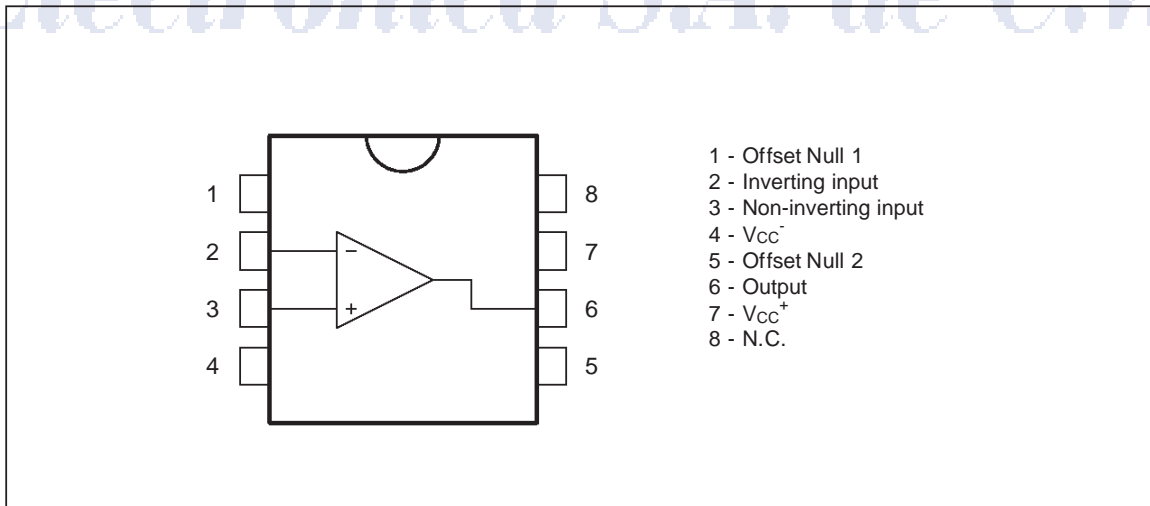

- 1 - Offset Null 1
- 2 - Inverting input
- 3 - Non-inverting input
- 4 - V_{CC}^-
- 5 - Offset Null 2
- 6 - Output
- 7 - V_{CC}^+
- 8 - N.C.

TL081 - TL081A - TL081B

SCHEMATIC DIAGRAM

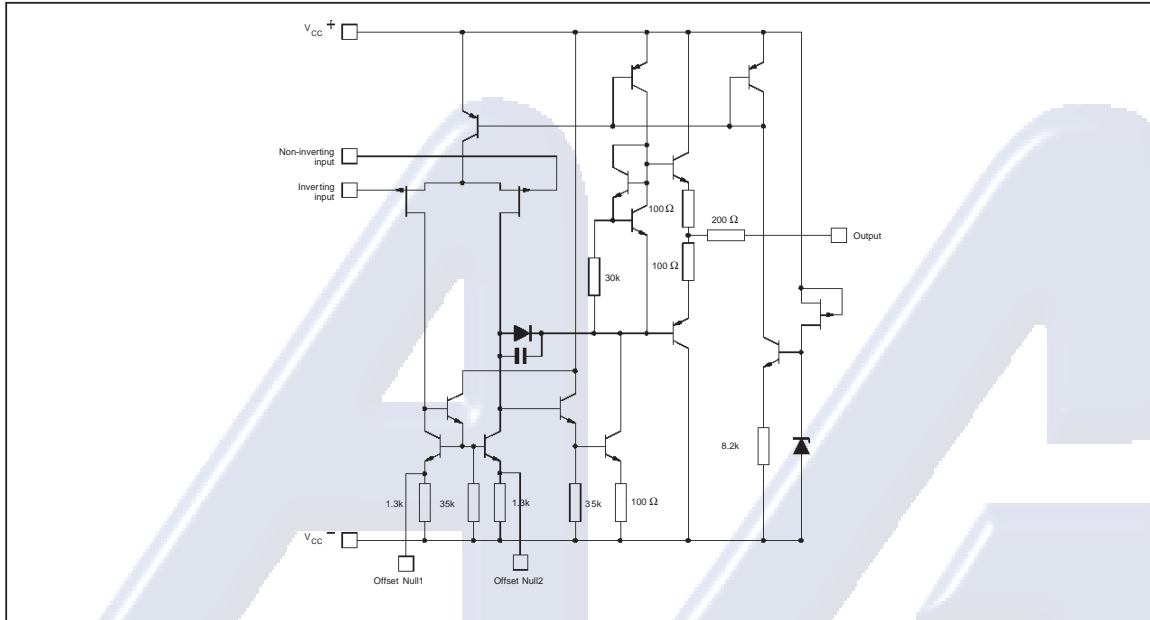

INPUT OFFSET VOLTAGE NULL CIRCUITS

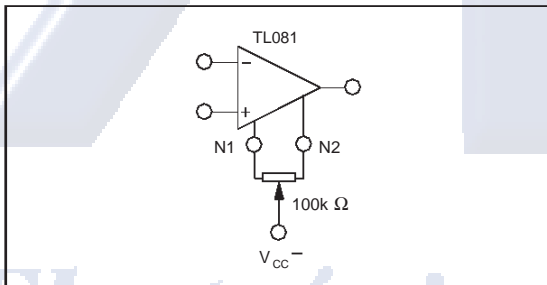

ABSOLUTE MAXIMUM RATINGS

Symbol	Parameter	Value	Unit	
V_{CC}	Supply Voltage - (note 1)	± 18	V	
V_i	Input Voltage - (note 3)	± 15	V	
V_{id}	Differential Input Voltage - (note 2)	± 30	V	
P_{tot}	Power Dissipation	680	mW	
	Output Short-circuit Duration - (note 4)	Infinite		
T_{oper}	Operating Free Air Temperature Range	TL081C,AC,BC TL081I,AI,BI TL081M,AM,BM	0 to 70 -40 to 105 -55 to 125	$^{\circ}C$
T_{stg}	Storage Temperature Range		-65 to 150	$^{\circ}C$

- Notes :
1. All voltage values, except differential voltage, are with respect to the zero reference level (ground) of the supply voltages where the zero reference level is the midpoint between V_{CC+} and V_{CC-} .
 2. Differential voltages are at the non-inverting input terminal with respect to the inverting input terminal.
 3. The magnitude of the input voltage must never exceed the magnitude of the supply voltage or 15 volts, whichever is less.
 4. The output may be shorted to ground or to either supply. Temperature and /or supply voltages must be limited to ensure that the dissipation rating is not exceeded.



TL081 - TL081A - TL081B

ELECTRICAL CHARACTERISTICS

V_{CC} = ±15V, T_{amb} = 25°C (unless otherwise specified)

Symbol	Parameter	TL081I,M,AC,AI, AM,BC,BI,BM			TL081C			Unit
		Min.	Typ.	Max.	Min.	Typ.	Max.	
V _{io}	Input Offset Voltage (R _S = 50Ω) T _{amb} = 25°C T _{min.} ≤ T _{amb} ≤ T _{max.} TL081 TL081A TL081B TL081 TL081A TL081B		3 3 1	10 6 3 13 7 5		3	10 13	mV
DV _{io}	Input Offset Voltage Drift		10			10		μV/°C
I _{io}	Input Offset Current * T _{amb} = 25°C T _{min.} ≤ T _{amb} ≤ T _{max.}		5	100 4		5	100 4	pA nA
I _{ib}	Input Bias Current * T _{amb} = 25°C T _{min.} ≤ T _{amb} ≤ T _{max.}		20	200 20		20	400 20	pA nA
A _{vd}	Large Signal Voltage Gain (R _L = 2kΩ, V _O = ±10V) T _{amb} = 25°C T _{min.} ≤ T _{amb} ≤ T _{max.}	50 25	200		25 15	200		V/mV
SVR	Supply Voltage Rejection Ratio (R _S = 50Ω) T _{amb} = 25°C T _{min.} ≤ T _{amb} ≤ T _{max.}	80 80	86		70 70	86		dB
I _{CC}	Supply Current, no Load T _{amb} = 25°C T _{min.} ≤ T _{amb} ≤ T _{max.}		1.4	2.5 2.5		1.4	2.5 2.5	mA
V _{icm}	Input Common Mode Voltage Range	±11	+15 -12		±11	+15 -12		V
CMR	Common Mode Rejection Ratio (R _S = 50Ω) T _{amb} = 25°C T _{min.} ≤ T _{amb} ≤ T _{max.}	80 80	86		70 70	86		dB
I _{os}	Output Short-circuit Current T _{amb} = 25°C T _{min.} ≤ T _{amb} ≤ T _{max.}	10 10	40	60 60	10 10	40	60 60	mA
±V _{OPP}	Output Voltage Swing T _{amb} = 25°C T _{min.} ≤ T _{amb} ≤ T _{max.} R _L = 2kΩ R _L = 10kΩ R _L = 2kΩ R _L = 10kΩ	10 12 10 12	12 13.5		10 12 10 12	12 13.5		V
SR	Slew Rate (V _{in} = 10V, R _L = 2kΩ, C _L = 100pF, T _{amb} = 25°C, unity gain)	8	16		8	16		V/μs
t _r	Rise Time (V _{in} = 20mV, R _L = 2kΩ, C _L = 100pF, T _{amb} = 25°C, unity gain)		0.1			0.1		μs
K _{OV}	Overshoot (V _{in} = 20mV, R _L = 2kΩ, C _L = 100pF, T _{amb} = 25°C, unity gain)		10			10		%
GBP	Gain Bandwidth Product (f = 100kHz, T _{amb} = 25°C, V _{in} = 10mV, R _L = 2kΩ, C _L = 100pF)	2.5	4		2.5	4		MHz
R _i	Input Resistance		10 ¹²			10 ¹²		Ω
THD	Total Harmonic Distortion (f = 1kHz, A _V = 20dB, R _L = 2kΩ, C _L = 100pF, T _{amb} = 25°C, V _O = 2V _{PP})		0.01			0.01		%
e _n	Equivalent Input Noise Voltage (f = 1kHz, R _S = 100Ω)		15			15		$\frac{nV}{\sqrt{Hz}}$
∅ _m	Phase Margin		45			45		Degrees

* The input bias currents are junction leakage currents which approximately double for every 10°C increase in the junction temperature.



TL081 - TL081A - TL081B

MAXIMUM PEAK-TO-PEAK OUTPUT VOLTAGE VERSUS FREQUENCY

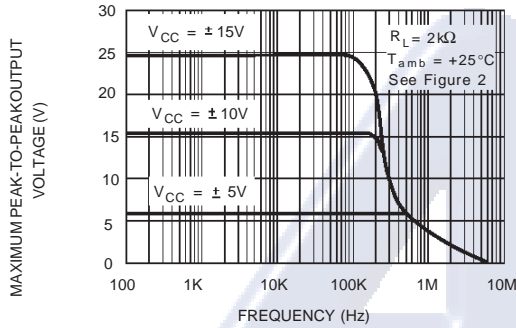

MAXIMUM PEAK-TO-PEAK OUTPUT VOLTAGE VERSUS FREQUENCY

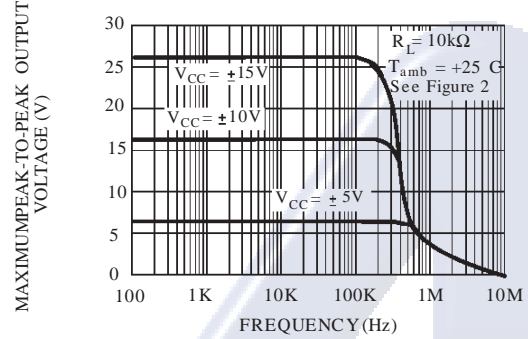

MAXIMUM PEAK-TO-PEAK OUTPUT VOLTAGE VERSUS FREQUENCY

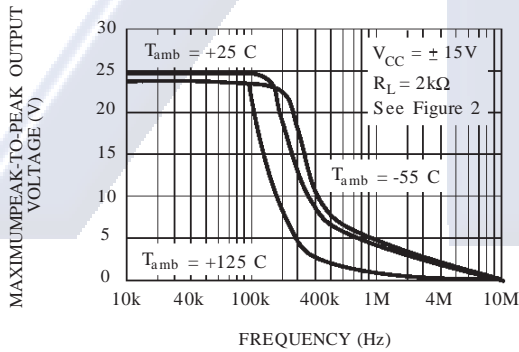

MAXIMUM PEAK-TO-PEAK OUTPUT VOLTAGE VERSUS FREE AIR TEMP.

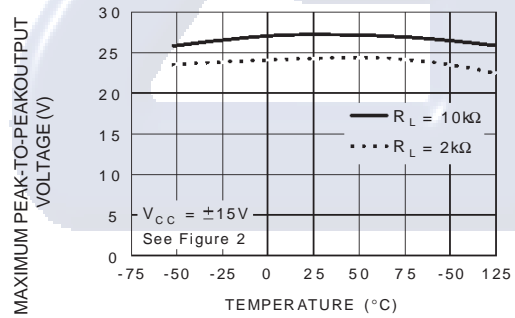

MAXIMUM PEAK-TO-PEAK OUTPUT VOLTAGE VERSUS LOAD RESISTANCE

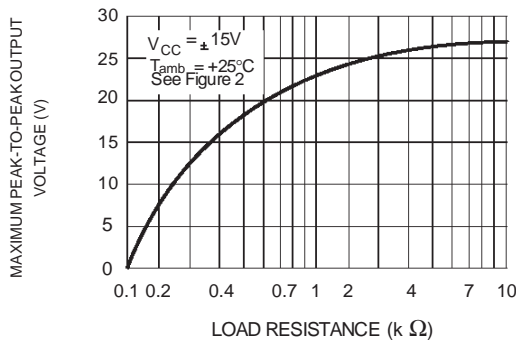

MAXIMUM PEAK-TO-PEAK OUTPUT VOLTAGE VERSUS SUPPLY VOLTAGE

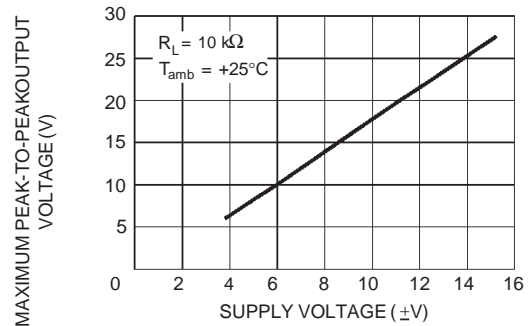

TL081 - TL081A - TL081B

**INPUT BIAS CURRENT VERSUS
FREE AIR TEMPERATURE**

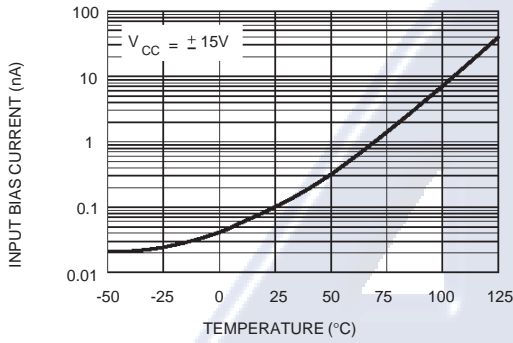

**LARGE SIGNAL DIFFERENTIAL
VOLTAGE AMPLIFICATION VERSUS
FREE AIR TEMPERATURE**

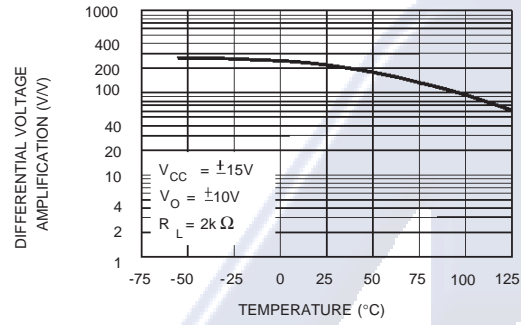

**LARGE SIGNAL DIFFERENTIAL
VOLTAGE AMPLIFICATION AND PHASE
SHIFT VERSUS FREQUENCY**

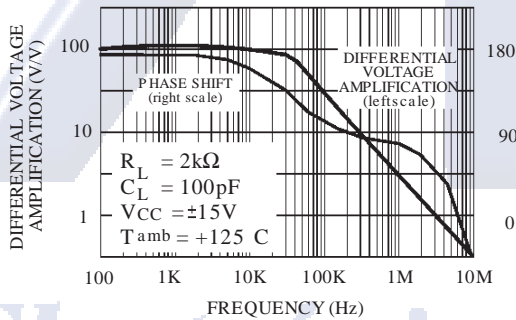

**TOTAL POWER DISSIPATION VERSUS
FREE AIR TEMPERATURE**

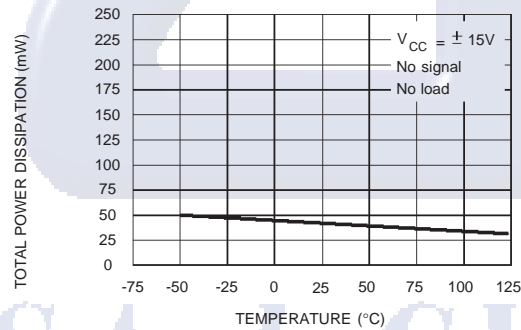

**SUPPLY CURRENT PER AMPLIFIER
VERSUS FREE AIR TEMPERATURE**

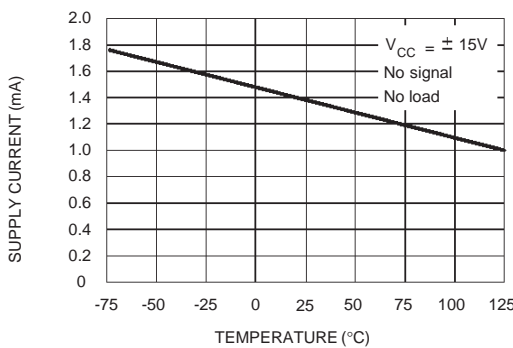

**SUPPLY CURRENT PER AMPLIFIER
VERSUS SUPPLY VOLTAGE**

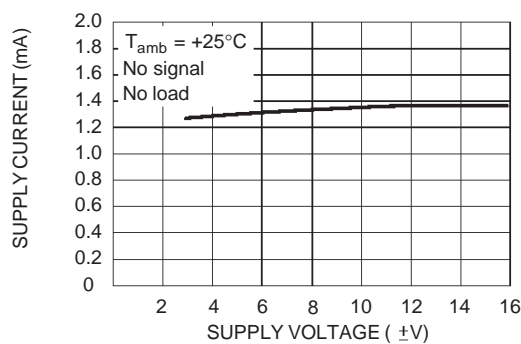

TL081 - TL081A - TL081B

**COMMON MODE REJECTION RATIO
VERSUS FREE AIR TEMPERATURE**

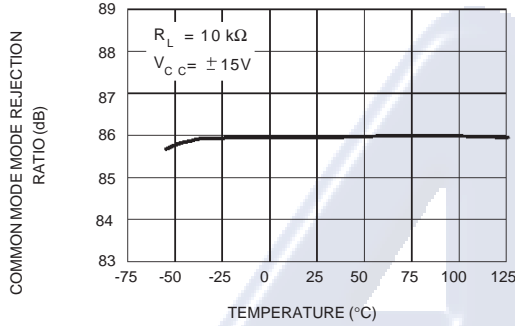

**VOLTAGE FOLLOWER LARGE SIGNAL
PULSE RESPONSE**

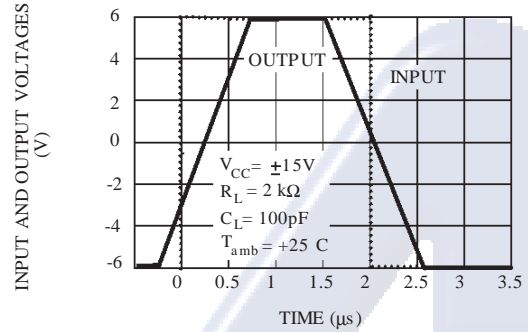

**OUTPUT VOLTAGE VERSUS
ELAPSED TIME**

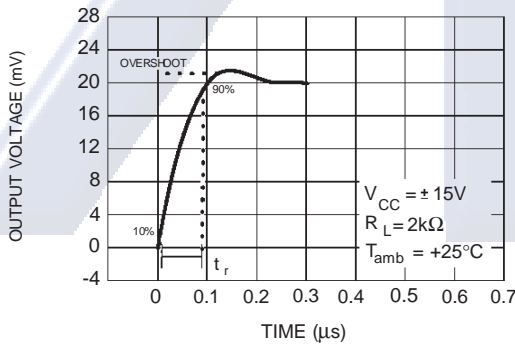

**EQUIVALENT INPUT NOISE VOLTAGE
VERSUS FREQUENCY**

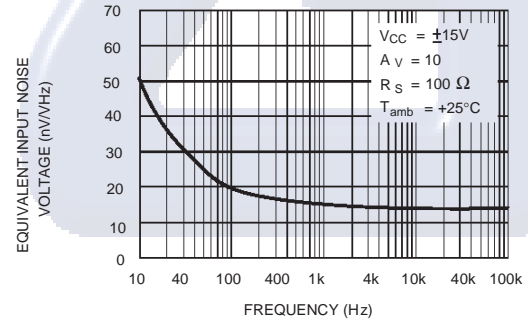

Electrónica S.A. de C.V.

**TOTAL HARMONIC DISTORTION VERSUS
FREQUENCY**

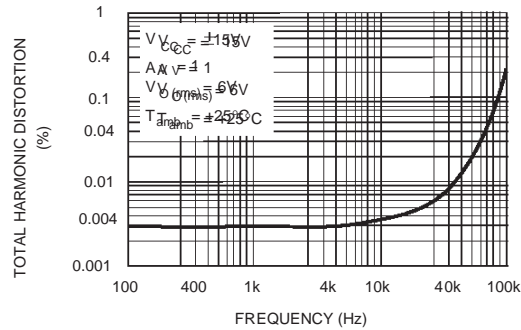

TL081 - TL081A - TL081B

PARAMETER MEASUREMENT INFORMATION

Figure 1 : Voltage Follower

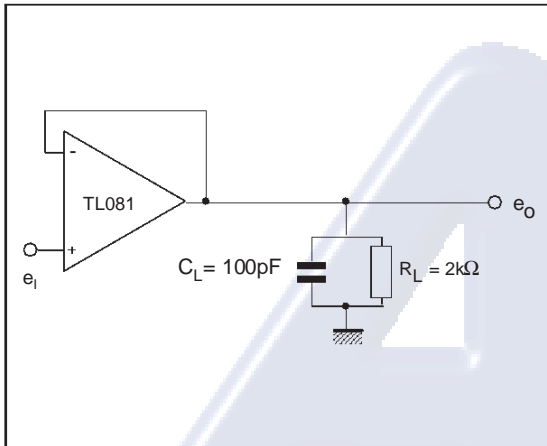
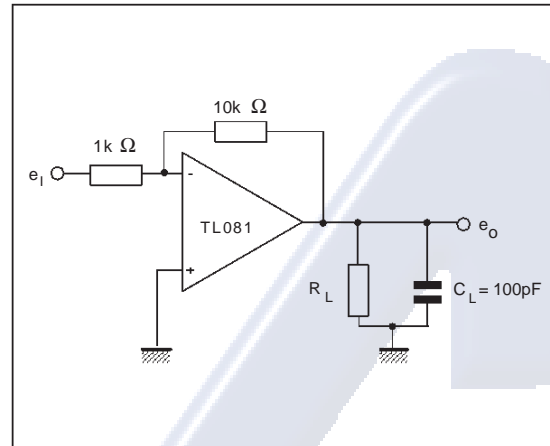
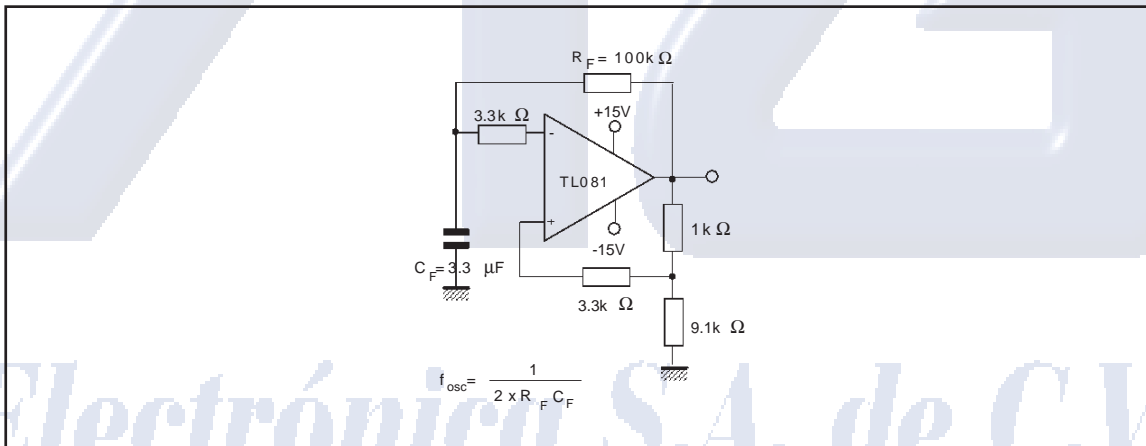

Figure 2 : Gain-of-10 Inverting Amplifier



TYPICAL APPLICATIONS

(0.5Hz) SQUARE WAVE OSCILLATOR



HIGH Q NOTCH FILTER

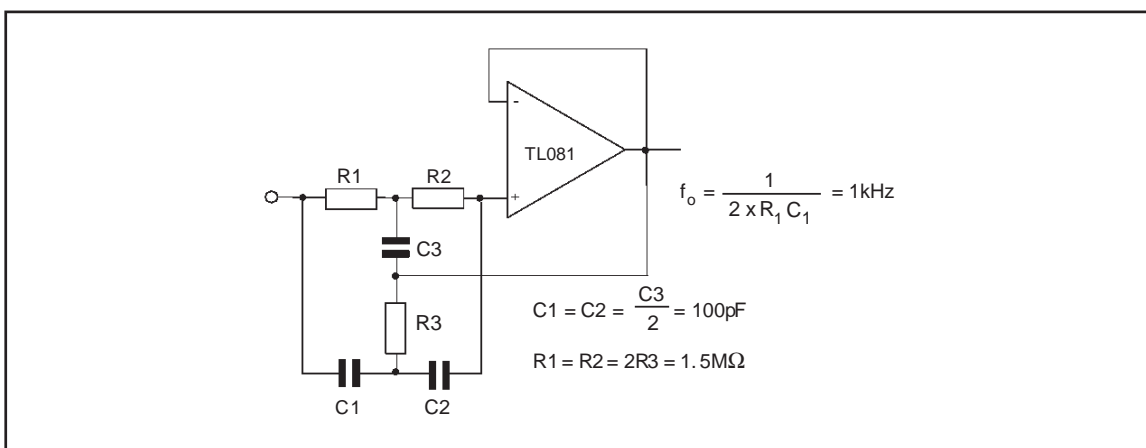

TL081 - TL081A - TL081B

PACKAGE MECHANICAL DATA
8 PINS - PLASTIC DIP

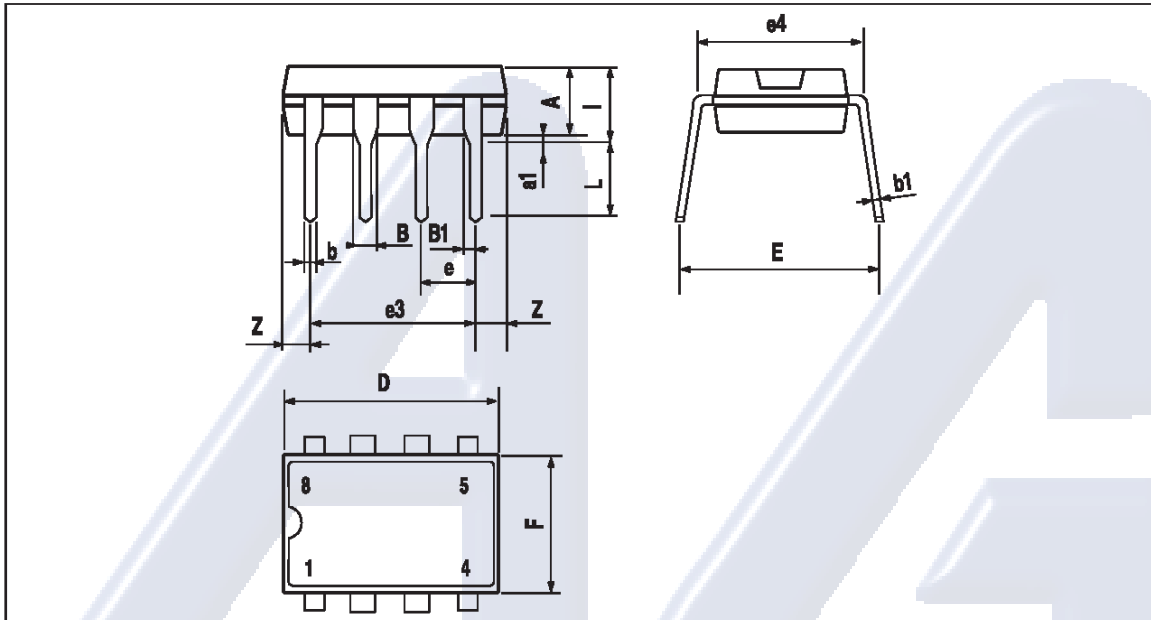

Dimensions	Millimeters			Inches		
	Min.	Typ.	Max.	Min.	Typ.	Max.
A		3.32			0.131	
a1	0.51			0.020		
B	1.15		1.65	0.045		0.065
b	0.356		0.55	0.014		0.022
b1	0.204		0.304	0.008		0.012
D			10.92			0.430
E	7.95		9.75	0.313		0.384
e		2.54			0.100	
e3		7.62			0.300	
e4		7.62			0.300	
F			6.6			0.260
i			5.08			0.200
L	3.18		3.81	0.125		0.150
Z			1.52			0.060

TL081 - TL081A - TL081B

PACKAGE MECHANICAL DATA
8 PINS - PLASTIC MICROPACKAGE (SO)

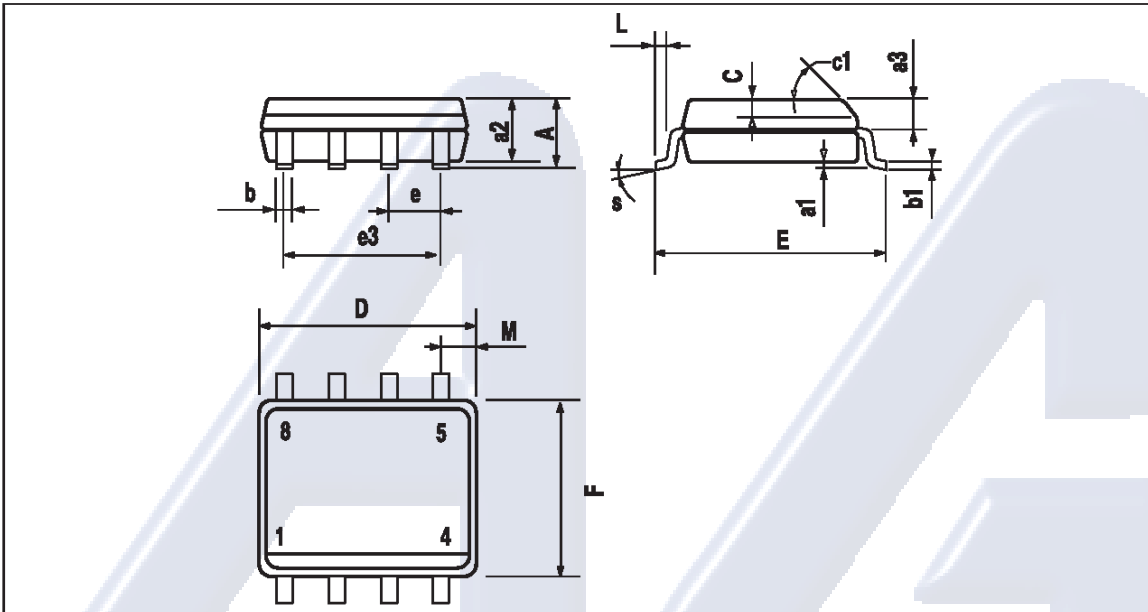

Dimensions	Millimeters			Inches		
	Min.	Typ.	Max.	Min.	Typ.	Max.
A			1.75			0.069
a1	0.1		0.25	0.004		0.010
a2			1.65			0.065
a3	0.65		0.85	0.026		0.033
b	0.35		0.48	0.014		0.019
b1	0.19		0.25	0.007		0.010
C	0.25		0.5	0.010		0.020
c1	45° (typ.)					
D	4.8		5.0	0.189		0.197
E	5.8		6.2	0.228		0.244
e		1.27			0.050	
e3		3.81			0.150	
F	3.8		4.0	0.150		0.157
L	0.4		1.27	0.016		0.050
M			0.6			0.024
S	8° (max.)					

Information furnished is believed to be accurate and reliable. However, STMicroelectronics assumes no responsibility for the consequences of use of such information nor for any infringement of patents or other rights of third parties which may result from its use. No license is granted by implication or otherwise under any patent or patent rights of STMicroelectronics. Specifications mentioned in this publication are subject to change without notice. This publication supersedes and replaces all information previously supplied. STMicroelectronics products are not authorized for use as critical components in life support devices or systems without express written approval of STMicroelectronics.

© The ST logo is a trademark of STMicroelectronics

© 1998 STMicroelectronics – Printed in Italy – All Rights Reserved

STMicroelectronics GROUP OF COMPANIES

Australia - Brazil - Canada - China - France - Germany - Italy - Japan - Korea - Malaysia - Malta - Mexico - Morocco
The Netherlands - Singapore - Spain - Sweden - Switzerland - Taiwan - Thailand - United Kingdom - U.S.A.

© <http://www.st.com>

