

# TLJ Series

## Tantalum Solid Electrolytic Chip Capacitors - High CV Consumer Series



### FEATURES

- High Volumetric Efficiency
- 3x reflow 260°C compatible
- 14 case sizes available including low profile codes
- Environmentally friendly
- Consumer applications (e.g. mobiles phones, PDA etc.)
- CV range: 10-1500µF / 2.5-20V



LEAD-FREE  
LEAD-FREE COMPATIBLE  
COMPONENT

### APPLICATIONS

- Mobile phones
- MP3/4 players

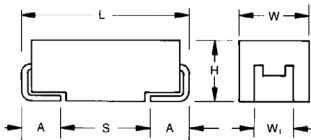

### MARKING

A, B, F, G, H, K, S, T, V, W, Y  
CASE

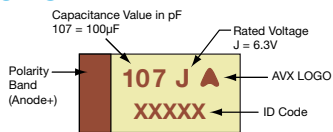

### N, P, R CASE

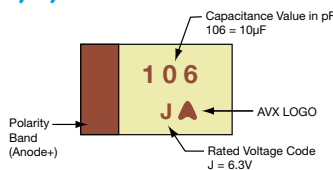

### STANDARD CASE DIMENSIONS: millimeters (inches)

Code	EIA Code	EIA Metric	L±0.20 (0.008)	W+0.20 (0.008) -0.10 (0.004)	H+0.20 (0.008) -0.10 (0.004)	W <sub>1</sub> ±0.20 (0.008)	A+0.30 (0.012) -0.20 (0.008)	S Min.
A	1206	3216-18	3.20 (0.126)	1.60 (0.063)	1.60 (0.063)	1.20 (0.047)	0.80 (0.031)	1.10 (0.043)
B	1210	3528-21	3.50 (0.138)	2.80 (0.110)	1.90 (0.075)	2.20 (0.087)	0.80 (0.031)	1.40 (0.055)
F	2312	6032-20	6.00 (0.236)	3.20 (0.126)	2.00 (0.079) max.	2.20 (0.087)	1.30 (0.051)	2.90 (0.114)
G	1206	3216-15	3.20 (0.126)	1.60 (0.063)	1.50 (0.059) max.	1.20 (0.047)	0.80 (0.031)	1.10 (0.043)
H	1210	3528-15	3.50 (0.138)	2.80 (0.110)	1.50 (0.059) max.	2.20 (0.087)	0.80 (0.031)	1.40 (0.055)
K	1206	3216-10	3.20 (0.126)	1.60 (0.063)	1.00 (0.039) max.	1.20 (0.047)	0.80 (0.031)	1.10 (0.043)
N	0805	2012-10	2.05 (0.081)	1.30 (0.051)	1.00 (0.039) max.	1.00 (0.039)	0.50 (0.020)	0.85 (0.033)
P	0805	2012-15	2.05 (0.081)	1.35 (0.053)	1.50 (0.059) max.	1.00±0.10 (0.039±0.004)	0.50 (0.020)	0.85 (0.033)
R	0805	2012-12	2.05 (0.081)	1.30 (0.051)	1.20 (0.047) max.	1.00±0.10 (0.039±0.004)	0.50 (0.020)	0.85 (0.033)
S	1206	3216-12	3.20 (0.126)	1.60 (0.063)	1.20 (0.047) max.	1.20 (0.047)	0.80 (0.031)	1.10 (0.043)
T	1210	3528-12	3.50 (0.138)	2.80 (0.110)	1.20 (0.047) max.	2.20 (0.087)	0.80 (0.031)	1.40 (0.033)
V	2924	7361-38	7.30 (0.287)	6.10 (0.240)	3.55 (0.140)	3.10 (0.122)	1.30 (0.051)	4.40 (0.173)
W	2312	6032-15	6.00 (0.236)	3.20 (0.126)	1.50 (0.059) max.	2.20 (0.087)	1.30 (0.051)	2.90 (0.114)
Y	2917	7343-20	7.30 (0.287)	4.30 (0.169)	2.00 (0.079) max.	2.40 (0.094)	1.30 (0.051)	4.40 (0.173)

W<sub>1</sub> dimension applies to the termination width for A dimensional area only.

### HOW TO ORDER

**TAJ**

Type

**W**

Case Size  
See table above

**157**

Capacitance Code  
pF code: 1st two digits represent significant figures, 3rd digit represents multiplier (number of zeros to follow)

**M**

Tolerance  
M = ±20%

**010**

Rated DC Voltage  
002 = 2.5Vdc  
004 = 4Vdc  
006 = 6.3Vdc  
010 = 10Vdc  
016 = 16Vdc  
020 = 20Vdc

**R**

Packaging  
R = Pure Tin 7" Reel  
S = Pure Tin 13" Reel

**0200**

ESR in mΩ

### TECHNICAL SPECIFICATIONS

Technical Data:	All technical data relate to an ambient temperature of +25°C							
Capacitance Range:	10 µF to 1500 µF							
Capacitance Tolerance:	±20%							
Rated Voltage (V <sub>R</sub> )	-55°C ≤ +40°C:	2.5	4	6.3	10	16	20	
Category Voltage (V <sub>C</sub> )	at 85°C:	1.3	2	3.2	5	8	10	
Category Voltage (V <sub>C</sub> )	at 125°C:	0.5	0.8	1.3	2	3.2	4	
Temperature Range:	-55°C to +125°C with category voltage							
Reliability:	0.2% per 1000 hours at 85°C, 0.5xV <sub>R</sub> with 0.1Ω/V series impedance with 60% confidence level							



# TLJ Series

## Tantalum Solid Electrolytic Chip Capacitors - High CV Consumer Series



### CAPACITANCE AND RATED VOLTAGE RANGE (LETTER DENOTES CASE SIZE)

Capacitance		Rated Voltage DC to 40°C / 0.5DC to 85°C / 0.2DC to 125°C					
µF	Code	2.5V (e)	4V (G)	6.3V (J)	10V (A)	16V (C)	20V (D)
6.8	685						
10	106				N(2500)/ R(2000,3000)	S(2200)	T(1000)
15	156				R(2000)		
22	226			N(5400)/R(3500)	K(1800)/N(3800)/ R(3800)	T(1000)	
33	336		N(8000)/R(3000)	K(1700)/N(8000)/ P(3000)/R(3000)	K(1500)/N(9600) P(3500) R(3500)/S(1500)	T(1000)	
47	476		K(1500)/N(4000)/ P(3000)/R(3000)	K(1500)/N(8300)/ P(700,900,1800,2500)/ R(3200)/S(1500)	A(600)/G(1500)/ P(3200)/R(3200)/ S(1500)/T(600)		
68	686		K(1200)/N(8000)/ P(3000)/ R(2900)/S(1500)	A(500)/G(800)/K(2000)/ S(1500)/T(600)	A(1500)		
100	107		A(500)/G(800)/ K(2000)/P(2700)/ S(1400)	A(500,800)/G(800)/ K(2000)/P(5400)/T(800)	A(1400)/ H(900)/T(900)		
150	157		A(800)/T(800)	A(900)/H(900)/T(1200)	B(500)/W(150,200)		
220	227	T(1100)	A(1100)/G(3000) H(900)/T(1100)	B(500)/T(2000)/W(200)	F(300)		
330	337		T(2700)/W(200)	F(300)			
470	477						
680	687			Y(100,150)			
1000	108						
1500	158			V(100)			

Released ratings, (ESR ratings in mOhms in parentheses)

Note: Voltage ratings are minimum values. AVX reserves the right to supply higher voltage ratings in the same case size, to the same reliability standards.

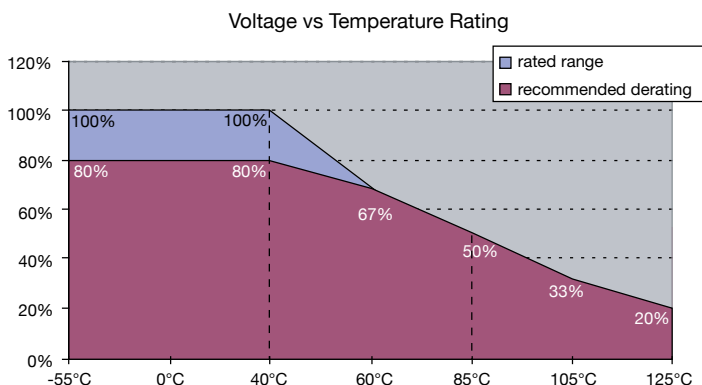

The Important Information/Disclaimer is incorporated in these specifications by reference and should be reviewed in full before placing any order.

031320

### RATINGS & PART NUMBER REFERENCE

AVX Part No.	Case Size	Capacitance (µF)	Rated Voltage (V)	Rated Temperature (°C)	Category Voltage (V)	Category Temperature (°C)	Maximum Surge Current (A)	DCL Max. (µA)	ESR Max. @ 100kHz (mΩ)	100kHz RMS Current (mA)			Product Category	MSL
										25°C	85°C	125°C		
<b>2.5 Volt @ 40°C</b>														
TLJT227M002#1200	T	220	2.5	40	0.5	125	0.8	5.5	1100	270	243	108	2	3
<b>4 Volt @ 40°C</b>														
TLJN336M004#8000	N	33	4	40	0.8	125	0.2	1.3	8000	79	71	32	1	3
TLJR336M004#3000	R	33	4	40	0.8	125	0.6	1.3	3000	135	122	54	2	3
TLJK476M004#1500	K	47	4	40	0.8	125	1.0	1.9	1500	208	187	83	2	3
TLJN476M004#4000	N	47	4	40	0.8	125	0.6	1.9	4000	112	101	45	1	3
TLJP476M004#3000	P	47	4	40	0.8	125	0.6	1.9	3000	141	127	57	2	3
TLJR476M004#3000	R	47	4	40	0.8	125	0.6	1.9	3000	135	122	54	2	3
TLJK686M004#1200	K	68	4	40	0.8	125	1.2	2.7	1200	233	209	93	2	3
TLJN686M004#8000	N	68	4	40	0.8	125	0.2	5.4	8000	79	71	32	1	3
TLJP686M004#3000	P	68	4	40	0.8	125	1.2	2.7	3000	141	127	57	2	3
TLJR686M004#2900	R	68	4	40	0.8	125	0.6	2.7	2900	138	124	55	2	3
TLJS686M004#1500	S	68	4	40	0.8	125	1.0	2.7	1500	208	187	83	2	3
TLJA107M004#0500	A	100	4	40	0.8	125	2.1	4.0	500	387	349	155	1	3
TLJG107M004#0800	G	100	4	40	0.8	125	1.6	4.0	800	296	266	118	2	3
TLJK107M004#2000	K	100	4	40	0.8	125	0.8	8.0	2000	180	162	72	2	3
TLJP107M004#2700	P	100	4	40	0.8	125	0.6	8.0	2700	149	134	60	2	3
TLJS107M004#1400	S	100	4	40	0.8	125	1.1	4.0	1400	215	194	86	2	3
TLJA157M004#0800	A	150	4	40	0.8	125	1.6	6.0	800	306	276	122	2	3
TLJT157M004#0800	T	150	4	40	0.8	125	1.6	6.0	800	316	285	126	2	3
TLJA227M004#1100	A	220	4	40	0.8	125	1.3	17.6	1100	261	235	104	2	3
TLJG227M004#3000	G	220	4	40	0.8	125	0.6	17.6	3000	153	137	61	2	3
TLJH227M004#0900	H	220	4	40	0.8	125	1.5	8.8	900	298	268	119	2	3
TLJT227M004#1100	T	220	4	40	0.8	125	1.3	17.6	1100	270	243	108	2	3
TLJT337M004#2700	T	330	4	40	0.8	125	0.6	26.4	2700	172	155	69	2	3
TLJW337M004#0200	W	330	4	40	0.8	125	3.1	13.2	200	671	604	268	1	3
<b>6.3 Volt @ 40°C</b>														
TLJN226M006#5400	N	22	6.3	40	1.3	125	0.5	1.3	5400	96	87	38	1	3
TLJR226M006#3500	R	22	6.3	40	1.3	125	0.8	1.3	3500	125	113	50	2	3
TLJK336M006#1700	K	33	6.3	40	1.3	125	1.5	2.0	1700	196	176	78	2	3
TLJN336M006#8000	N	33	6.3	40	1.3	125	0.4	2.0	8000	79	71	32	1	3
TLJP336M006#3000	P	33	6.3	40	1.3	125	0.9	2.0	3000	141	127	57	1	3
TLJR336M006#3000	R	33	6.3	40	1.3	125	0.9	2.0	3000	135	122	54	2	3
TLJK476M006#1500	K	47	6.3	40	1.3	125	1.6	2.8	1500	208	187	83	2	3
TLJN476M006#8300	N	47	6.3	40	1.3	125	0.4	5.6	8300	78	70	31	1	3
TLJP476M006#0700	P	47	6.3	40	1.3	125	2.7	2.8	700	293	263	117	2	3
TLJP476M006#0900	P	47	6.3	40	1.3	125	2.3	2.8	900	258	232	103	2	3
TLJP476M006#1800	P	47	6.3	40	1.3	125	1.4	2.8	1800	183	164	73	2	3
TLJP476M006#2500	P	47	6.3	40	1.3	125	1.1	2.8	2500	155	139	62	2	3
TLJR476M006#3200	R	47	6.3	40	1.3	125	0.9	2.8	3200	131	118	52	2	3
TLJS476M006#1500	S	47	6.3	40	1.3	125	1.6	2.8	1500	208	187	83	2	3
TLJA686M006#0500	A	68	6.3	40	1.3	125	3.3	4.1	500	387	349	155	1	3
TLJG686M006#0800	G	68	6.3	40	1.3	125	1.9	4.1	800	296	266	118	2	3
TLJK686M006#2000	K	68	6.3	40	1.3	125	1.3	8.16	2000	180	162	72	2	3
TLJS686M006#1500	S	68	6.3	40	1.3	125	1.6	4.1	1500	208	187	83	2	3
TLJT686M006#0600	T	68	6.3	40	1.3	125	3.0	4.1	600	365	329	146	1	3
TLJA107M006#0500	A	100	6.3	40	1.3	125	3.3	6.0	500	387	349	155	2	3
TLJA107M006#0800	A	100	6.3	40	1.3	125	2.5	6.0	800	306	276	122	2	3
TLJG107M006#0800	G	100	6.3	40	1.3	125	2.5	6.0	800	296	266	118	2	3
TLJK107M006#2000	K	100	6.3	40	1.3	125	1.3	12.0	2000	180	162	72	2	3
TLJP107M006#5400	P	100	6.3	40	1.3	125	0.5	12.0	5400	105	95	42	2	3
TLJT107M006#0800	T	100	6.3	40	1.3	125	2.5	6.0	800	316	285	126	2	3
TLJA157M006#0900	A	150	6.3	40	1.3	125	2.3	9.0	900	289	260	115	2	3
TLJH157M006#0900	H	150	6.3	40	1.3	125	2.3	9.0	900	298	268	119	2	3
TLJT157M006#1200	T	150	6.3	40	1.3	125	1.9	9.0	1200	258	232	103	2	3
TLJB227M006#0500	B	220	6.3	40	1.3	125	3.3	13.2	500	412	371	165	1	3
TLJT227M006#2000	T	220	6.3	40	1.3	125	1.3	26.4	2000	200	180	80	2	3
TLJW227M006#0200	W	220	6.3	40	1.3	125	4.8	13.2	200	671	604	268	1	3
TLJF337M006#0300	F	330	6.3	40	1.3	125	4.2	19.8	300	577	520	231	1	3
TLJY687M006#0100	Y	680	6.3	40	1.3	125	5.7	40.8	100	1118	1006	447	1	3
TLJY687M006#0150	Y	680	6.3	40	1.3	125	5.7	40.8	150	913	822	365	1	3
TLJV158M006#0100	V	1500	6.3	40	1.3	125	5.7	90	100	1581	1423	632	1	3

# TLJ Series

## Tantalum Solid Electrolytic Chip Capacitors - High CV Consumer Series



### RATINGS & PART NUMBER REFERENCE

AVX Part No.	Case Size	Capacitance (µF)	Rated Voltage (V)	Rated Temperature (°C)	Category Voltage (V)	Category Temperature (°C)	Maximum Surge Current (A)	DCL Max. (µA)	ESR Max. @ 100kHz (mΩ)	100kHz RMS Current (mA)			Product Category	MSL
										25°C	85°C	125°C		
<b>10 Volt @ 40°C</b>														
TLJN106M010#2500	N	10	10	40	2	125	1.7	1.0	2500	141	127	57	1	3
TLJR106M010#2000	R	10	10	40	2	125	2.0	1.0	2000	166	149	66	1	3
TLJR106M010#3000	R	10	10	40	2	125	1.4	1.0	3000	135	122	54	1	3
TLJR156M010#2000	R	15	10	40	2	125	2.0	1.5	2000	166	149	66	1	3
TLJK226M010#1800	K	22	10	40	2	125	2.2	2.2	1800	167	150	67	2	3
TLJN226M010#3800	N	22	10	40	2	125	1.2	2.2	3800	115	103	46	1	3
TLJR226M010#3800	R	22	10	40	2	125	1.2	2.2	3800	120	108	48	2	3
TLJK336M010#1500	K	33	10	40	2	125	2.6	3.3	1500	208	187	83	2	3
TLJN336M010#9600	N	33	10	40	2	125	0.5	6.6	9600	72	65	29	1	3
TLJP336M010#3500	P	33	10	40	2	125	1.3	3.3	3500	131	118	52	2	3
TLJR336M010#3500	R	33	10	40	2	125	1.3	3.3	3500	125	113	50	2	3
TLJS336M010#1500	S	33	10	40	2	125	2.6	3.3	1500	208	187	83	2	3
TLJA476M010#0600	A	47	10	40	2	125	4.8	4.7	600	354	318	141	1	3
TLJG476M010#1500	G	47	10	40	2	125	2.6	4.7	1500	216	194	86	2	3
TLJP476M010#3200	P	47	10	40	2	125	1.4	4.7	3200	137	123	55	2	3
TLJR476M010#3200	R	47	10	40	2	125	1.4	9.4	3200	131	118	52	2	3
TLJS476M010#1500	S	47	10	40	2	125	2.6	4.7	1500	208	187	83	2	3
TLJT476M010#0600	T	47	10	40	2	125	4.8	4.7	600	365	329	146	1	3
TLJA686M010#1500	A	68	10	40	2	125	2.6	6.8	1500	224	201	89	2	3
TLJA107M010#1400	A	100	10	40	2	125	2.7	10.0	1400	231	208	93	2	3
TLJH107M010#0900	H	100	10	40	2	125	3.7	10.0	900	298	268	119	2	3
TLJT107M010#0900	T	100	10	40	2	125	3.7	10.0	900	298	268	119	2	3
TLJB157M010#0500	B	150	10	40	2	125	5.3	15.0	500	412	371	165	1	3
TLJW157M010#0150	W	150	10	40	2	125	8.3	15.0	150	775	697	310	1	3
TLJW157M010#0200	W	150	10	40	2	125	7.7	15.0	200	671	604	268	1	3
TLJF227M010#0300	F	220	10	40	2	125	6.7	22.0	300	577	520	231	1	3
<b>16 Volt @ 40°C</b>														
TLJS106M016#2200	S	10	16	40	3.2	125	3.0	1.6	2200	172	155	69	1	3
TLJT226M016#1000	T	22	16	40	3.2	125	5.5	3.5	1000	283	255	113	1	3
TLJT336M016#1000	T	33	16	40	3.2	125	5.5	5.3	1000	283	255	113	1	3
<b>20 Volt @ 40°C</b>														
TLJT106M020#1000	T	10	20	40	4	125	6.9	2.0	1000	283	255	113	1	3

Moisture Sensitivity Level (MSL) is defined according to J-STD-020.

All technical data relates to an ambient temperature of +25°C. Capacitance is measured at 120Hz, 0.5V RMS with a maximum DC bias of 2.2 volts. DCL is measured at rated voltage after 5 minutes.

ESR allowed to move up to 1.25 times catalogue limit post mounting

DCL allowed to move up to 2.00 times catalogue limit post mounting

For typical weight and composition see page 274.

**NOTE: AVX reserves the right to supply higher voltage ratings or tighter tolerance part in the same case size, to the same reliability standards.**

### QUALIFICATION TABLE – CATEGORY 1

TEST	TLJ series (Temperature range -55°C to +125°C)									
	Condition			Characteristics						
Endurance	Apply rated voltage (Ur) at 40°C and / or category voltage (Uc) at 85°C for 2000 hours through a circuit impedance of $\leq 0.1\Omega/V$ . Stabilize at room temperature for 1-2 hours before measuring.			Visual examination	no visible damage					
				DCL	2 x initial limit					
				$\Delta C/C$	within $\pm 10\%$ of initial value					
				ESR	1.25 x initial limit					
Humidity	Store at 65°C and 90-95% relative humidity for 500 hours, with no applied voltage. Stabilize at room temperature and humidity for 1-2 hours before measuring.			Visual examination	no visible damage					
				DCL	2 x initial limit					
				$\Delta C/C$	within $\pm 10\%$ of initial value					
				ESR	1.25 x initial limit					
Temperature Stability	Step	Temperature°C	Duration(min)							
	1	+20	15							
	2	-55	15	DCL	2 x IL*	n/a	2 x IL*	20 x IL*	25 x IL*	IL*
	3	+20	15	$\Delta C/C$	n/a	+0/-20%	$\pm 5\%$	+20/-0%	+25/-0%	$\pm 5\%$
	4	+85	15	ESR	1.25 x IL*	2.5 x IL*	1.25 x IL*	1.25 x IL*	1.25 x IL*	1.25 x IL*
	5	+125	15							
	6	+20	15							
Surge Voltage	Apply 1.3x rated voltage (Ur) at 40°C for 1000 cycles of duration 6 min (30 sec charge, 5 min 30 sec discharge) through a charge / discharge resistance of 1000 $\Omega$			Visual examination	no visible damage					
				DCL	2 x initial limit					
				$\Delta C/C$	within $\pm 5\%$ of initial value					
				ESR	1.25 x initial limit					
Mechanical Shock	MIL-STD-202, Method 213, Condition C			Visual examination	no visible damage					
				DCL	initial limit					
				$\Delta C/C$	within $\pm 5\%$ of initial value					
				DF	initial limit					
				ESR	initial limit					
Vibration	MIL-STD-202, Method 204, Condition D			Visual examination	no visible damage					
				DCL	initial limit					
				$\Delta C/C$	within $\pm 5\%$ of initial value					
				DF	initial limit					
				ESR	initial limit					

\*Initial Limit

### QUALIFICATION TABLE – CATEGORY 2

TEST	TLJ series (Temperature range -55°C to +125°C)									
	Condition			Characteristics						
Endurance	Apply rated voltage (Ur) at 40°C and / or category voltage (Uc) at 85°C for 2000 hours through a circuit impedance of $\leq 0.1\Omega/V$ . Stabilize at room temperature for 1-2 hours before measuring.			Visual examination	no visible damage					
				DCL	2 x initial limit					
				$\Delta C/C$	within +5/-30% of initial value					
				ESR	1.25 x initial limit					
Humidity	Store at 65°C and 90-95% relative humidity for 500 hours, with no applied voltage. Stabilize at room temperature and humidity for 1-2 hours before measuring.			Visual examination	no visible damage					
				DCL	2 x initial limit					
				$\Delta C/C$	within $\pm 10\%$ of initial value					
				ESR	1.25 x initial limit					
Temperature Stability	Step	Temperature°C	Duration(min)							
	1	+20	15							
	2	-55	15	DCL	2 x IL*	n/a	2 x IL*	20 x IL*	25 x IL*	2 x IL*
	3	+20	15	$\Delta C/C$	n/a	+5/-20%	$\pm 10\%$	+20/-0%	+25/-0%	$\pm 10\%$
	4	+85	15	ESR	1.25 x IL*	2.5 x IL*	1.25 x IL*	1.25 x IL*	1.25 x IL*	1.25 x IL*
	5	+125	15							
	6	+20	15							
Surge Voltage	Apply 1.3x rated voltage (Ur) at 40°C for 1000 cycles of duration 6 min (30 sec charge, 5 min 30 sec discharge) through a charge / discharge resistance of 1000 $\Omega$			Visual examination	no visible damage					
				DCL	2 x initial limit					
				$\Delta C/C$	within $\pm 5\%$ of initial value					
				ESR	1.25 x initial limit					
Mechanical Shock	MIL-STD-202, Method 213, Condition C			Visual examination	no visible damage					
				DCL	initial limit					
				$\Delta C/C$	within $\pm 5\%$ of initial value					
				DF	initial limit					
				ESR	initial limit					
Vibration	MIL-STD-202, Method 204, Condition D			Visual examination	no visible damage					
				DCL	initial limit					
				$\Delta C/C$	within $\pm 5\%$ of initial value					
				DF	initial limit					
				ESR	initial limit					

\*Initial Limit

# TLJ Series

## Tantalum Solid Electrolytic Chip Capacitors - High CV Consumer Series



### AVX SOLID ELECTROLYTIC CAPACITOR ROADMAP

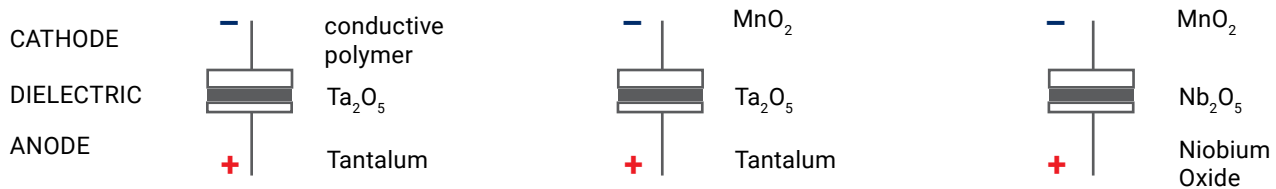
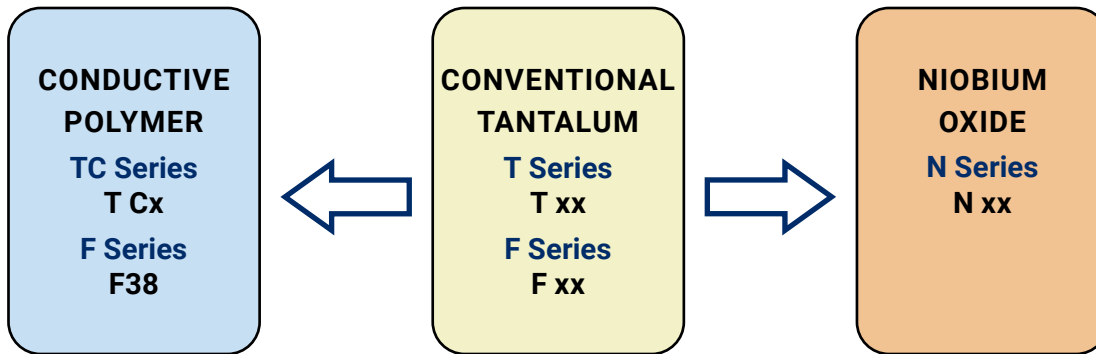

### FIVE CAPACITOR CONSTRUCTION STYLES

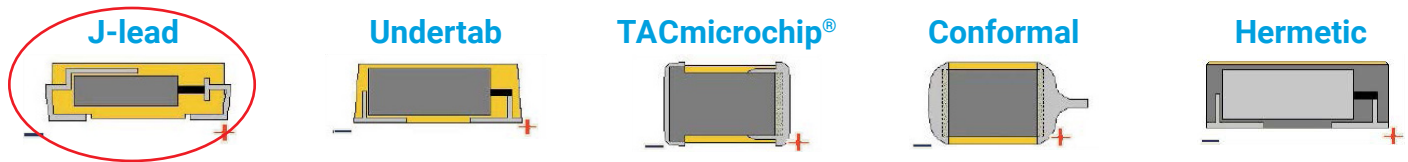

### SERIES LINE UP: CONVENTIONAL SMD MnO<sub>2</sub>

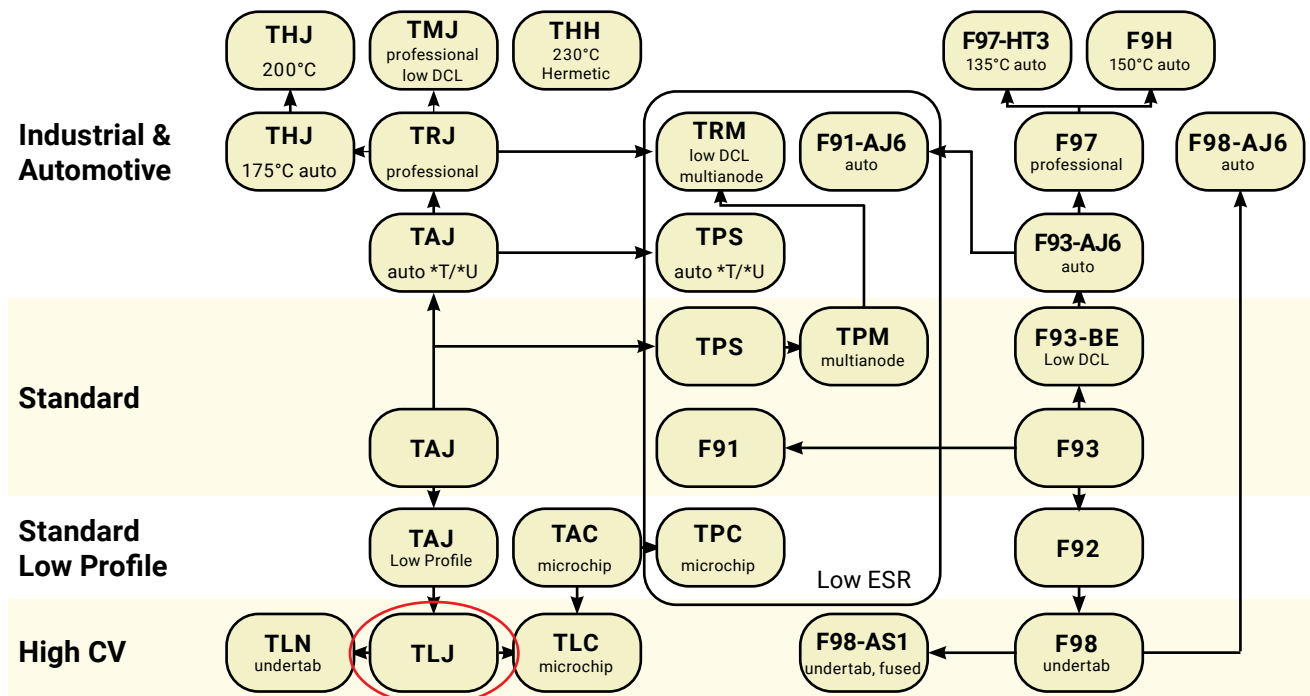

The Important Information/Disclaimer is incorporated in these specifications by reference and should be reviewed in full before placing any order.

## IMPORTANT INFORMATION/DISCLAIMER

All product specifications, statements, information and data (collectively, the “Information”) in this datasheet or made available on the website are subject to change. The customer is responsible for checking and verifying the extent to which the Information contained in this publication is applicable to an order at the time the order is placed. All Information given herein is believed to be accurate and reliable, but it is presented without guarantee, warranty, or responsibility of any kind, expressed or implied.

Statements of suitability for certain applications are based on AVX’s knowledge of typical operating conditions for such applications, but are not intended to constitute and AVX specifically disclaims any warranty concerning suitability for a specific customer application or use.

**ANY USE OF PRODUCT OUTSIDE OF SPECIFICATIONS OR ANY STORAGE OR INSTALLATION INCONSISTENT WITH PRODUCT GUIDANCE VOIDS ANY WARRANTY.**

The Information is intended for use only by customers who have the requisite experience and capability to determine the correct products for their application. Any technical advice inferred from this Information or otherwise provided by AVX with reference to the use of AVX’s products is given without regard, and AVX assumes no obligation or liability for the advice given or results obtained.

Although AVX designs and manufactures its products to the most stringent quality and safety standards, given the current state of the art, isolated component failures may still occur. Accordingly, customer applications which require a high degree of reliability or safety should employ suitable designs or other safeguards (such as installation of protective circuitry or redundancies) in order to ensure that the failure of an electrical component does not result in a risk of personal injury or property damage.

Unless specifically agreed to in writing, AVX has not tested or certified its products, services or deliverables for use in high risk applications including medical life support, medical device, direct physical patient contact, water treatment, nuclear facilities, weapon systems, mass and air transportation control, flammable environments, or any other potentially life critical uses. Customer understands and agrees that AVX makes no assurances that the products, services or deliverables are suitable for any high-risk uses. Under no circumstances does AVX warrant or guarantee suitability for any customer design or manufacturing process.

Although all product-related warnings, cautions and notes must be observed, the customer should not assume that all safety measures are indicated or that other measures may not be required.