



XR-2206

Monolithic Function Generator

June 1997-3

FEATURES

- Low-Sine Wave Distortion, 0.5%, Typical
- Excellent Temperature Stability, 20ppm/°C, Typ.
- Wide Sweep Range, 2000:1, Typical
- Low-Supply Sensitivity, 0.01%V, Typ.
- Linear Amplitude Modulation
- TTL Compatible FSK Controls
- Wide Supply Range, 10V to 26V
- Adjustable Duty Cycle, 1% TO 99%

APPLICATIONS

- Waveform Generation
- Sweep Generation
- AM/FM Generation
- V/F Conversion
- FSK Generation
- Phase-Locked Loops (VCO)

GENERAL DESCRIPTION

The XR-2206 is a monolithic function generator integrated circuit capable of producing high quality sine, square, triangle, ramp, and pulse waveforms of high-stability and accuracy. The output waveforms can be both amplitude and frequency modulated by an external voltage. Frequency of operation can be selected externally over a range of 0.01Hz to more than 1MHz.

The circuit is ideally suited for communications, instrumentation, and function generator applications requiring sinusoidal tone, AM, FM, or FSK generation. It has a typical drift specification of 20ppm/°C. The oscillator frequency can be linearly swept over a 2000:1 frequency range with an external control voltage, while maintaining low distortion.

ORDERING INFORMATION

Part No.	Package	Operating Temperature Range
XR-2206M	16 Lead 300 Mil CDIP	-55°C to +125°C
XR-2206P	16 Lead 300 Mil PDIP	-40°C to +85°C
XR-2206CP	16 Lead 300 Mil PDIP	0°C to +70°C
XR-2206D	16 Lead 300 Mil JEDEC SOIC	0°C to +70°C

Rev. 1.03

©1972

EXAR Corporation, 48720 Kato Road, Fremont, CA 94538 ♦ (510) 668-7000 ♦ (510) 668-7017



XR-2206

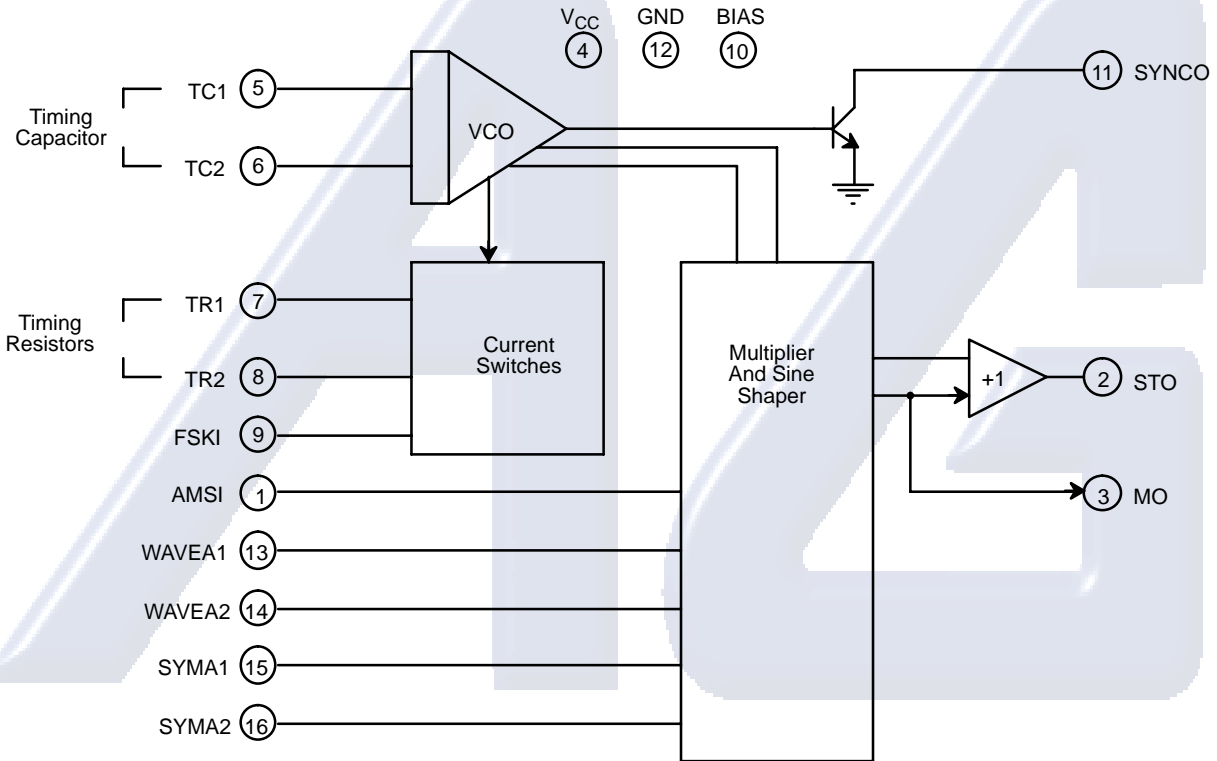

Electrónica S.A. de C.V.
Figure 1. XR-2206 Block Diagram

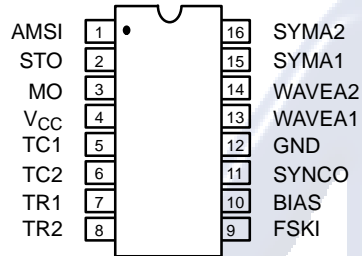

16 Lead PDIP, CDIP (0.300\')

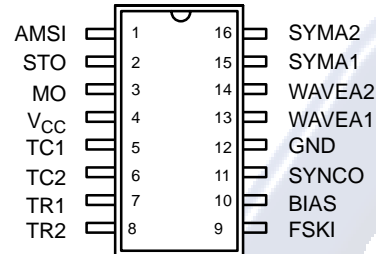

16 Lead SOIC (Jedec, 0.300\')

PIN DESCRIPTION

Pin #	Symbol	Type	Description
1	AMSI	I	Amplitude Modulating Signal Input.
2	STO	O	Sine or Triangle Wave Output.
3	MO	O	Multiplier Output.
4	V _{CC}		Positive Power Supply.
5	TC1	I	Timing Capacitor Input.
6	TC2	I	Timing Capacitor Input.
7	TR1	O	Timing Resistor 1 Output.
8	TR2	O	Timing Resistor 2 Output.
9	FSKI	I	Frequency Shift Keying Input.
10	BIAS	O	Internal Voltage Reference.
11	SYNCO	O	Sync Output. This output is a open collector and needs a pull up resistor to V _{CC} .
12	GND		Ground pin.
13	WAVEA1	I	Wave Form Adjust Input 1.
14	WAVEA2	I	Wave Form Adjust Input 2.
15	SYMA1	I	Wave Symetry Adjust 1.
16	SYMA2	I	Wave Symetry Adjust 2.

XR-2206



DC ELECTRICAL CHARACTERISTICS

Test Conditions: Test Circuit of *Figure 2* $V_{CC} = 12V$, $T_A = 25^\circ C$, $C = 0.01\mu F$, $R_1 = 100k\Omega$, $R_2 = 10k\Omega$, $R_3 = 25k\Omega$
 Unless Otherwise Specified. S_1 open for triangle, closed for sine wave.

Parameters	XR-2206M/P			XR-2206CP/D			Units	Conditions
	Min.	Typ.	Max.	Min.	Typ.	Max.		
General Characteristics								
Single Supply Voltage	10		26	10		26	V	
Split-Supply Voltage	± 5		± 13	± 5		± 13	V	
Supply Current		12	17		14	20	mA	$R_1 \geq 10k\Omega$
Oscillator Section								
Max. Operating Frequency	0.5	1		0.5	1		MHz	$C = 1000pF$, $R_1 = 1k\Omega$
Lowest Practical Frequency		0.01			0.01		Hz	$C = 50\mu F$, $R_1 = 2M\Omega$
Frequency Accuracy		± 1	± 4		± 2		% of f_o	$f_o = 1/R_1C$
Temperature Stability Frequency		± 10	± 50		± 20		ppm/ $^\circ C$	$0^\circ C \leq T_A \leq 70^\circ C$ $R_1 = R_2 = 20k\Omega$
Sine Wave Amplitude Stability ²		4800			4800		ppm/ $^\circ C$	
Supply Sensitivity		0.01	0.1		0.01		%/V	$V_{LOW} = 10V$, $V_{HIGH} = 20V$, $R_1 = R_2 = 20k\Omega$
Sweep Range	1000:1	2000:1			2000:1		$f_H = f_L$	$f_H @ R_1 = 1k\Omega$ $f_L @ R_1 = 2M\Omega$
Sweep Linearity								
10:1 Sweep		2			2		%	$f_L = 1kHz$, $f_H = 10kHz$
1000:1 Sweep		8			8		%	$f_L = 100Hz$, $f_H = 100kHz$
FM Distortion		0.1			0.1		%	$\pm 10\%$ Deviation
Recommended Timing Components								
Timing Capacitor: C	0.001		100	0.001		100	μF	<i>Figure 5</i>
Timing Resistors: R_1 & R_2	1		2000	1		2000	k Ω	
Triangle Sine Wave Output¹								<i>Figure 3</i>
Triangle Amplitude		160			160		mV/k Ω	<i>Figure 2</i> , S_1 Open
Sine Wave Amplitude	40	60	80		60		mV/k Ω	<i>Figure 2</i> , S_1 Closed
Max. Output Swing		6			6		V _{p-p}	
Output Impedance		600			600		Ω	
Triangle Linearity		1			1		%	
Amplitude Stability		0.5			0.5		dB	For 1000:1 Sweep
Sine Wave Distortion								
Without Adjustment		2.5			2.5		%	$R_1 = 30k\Omega$
With Adjustment		0.4	1.0		0.5	1.5	%	See <i>Figure 7</i> and <i>Figure 8</i>

Notes

¹ Output amplitude is directly proportional to the resistance, R_3 , on Pin 3. See *Figure 3*.

² For maximum amplitude stability, R_3 should be a positive temperature coefficient resistor.

Bold face parameters are covered by production test and guaranteed over operating temperature range.



XR-2206

DC ELECTRICAL CHARACTERISTICS (CONT'D)

Parameters	XR-2206M/P			XR-2206CP/D			Units	Conditions
	Min.	Typ.	Max.	Min.	Typ.	Max.		
Amplitude Modulation								
Input Impedance	50	100		50	100		k Ω	
Modulation Range		100			100		%	
Carrier Suppression		55			55		dB	
Linearity		2			2		%	For 95% modulation
Square-Wave Output								
Amplitude		12			12		Vp-p	Measured at Pin 11.
Rise Time		250			250		ns	$C_L = 10\text{pF}$
Fall Time		50			50		ns	$C_L = 10\text{pF}$
Saturation Voltage		0.2	0.4		0.2	0.6	V	$I_L = 2\text{mA}$
Leakage Current		0.1	20		0.1	100	μA	$V_{CC} = 26\text{V}$
FSK Keying Level (Pin 9)	0.8	1.4	2.4	0.8	1.4	2.4	V	See section on circuit controls
Reference Bypass Voltage	2.9	3.1	3.3	2.5	3	3.5	V	Measured at Pin 10.

Notes

¹ Output amplitude is directly proportional to the resistance, R_3 , on Pin 3. See Figure 3.

² For maximum amplitude stability, R_3 should be a positive temperature coefficient resistor.

Bold face parameters are covered by production test and guaranteed over operating temperature range.

Specifications are subject to change without notice

ABSOLUTE MAXIMUM RATINGS

Power Supply 26V
 Power Dissipation 750mW
 Derate Above 25°C 5mW/°C

Total Timing Current 6mA
 Storage Temperature -65°C to +150°C

SYSTEM DESCRIPTION

The XR-2206 is comprised of four functional blocks; a voltage-controlled oscillator (VCO), an analog multiplier and sine-shaper; a unity gain buffer amplifier; and a set of current switches.

The VCO produces an output frequency proportional to an input current, which is set by a resistor from the timing

terminals to ground. With two timing pins, two discrete output frequencies can be independently produced for FSK generation applications by using the FSK input control pin. This input controls the current switches which select one of the timing resistor currents, and routes it to the VCO.

XR-2206

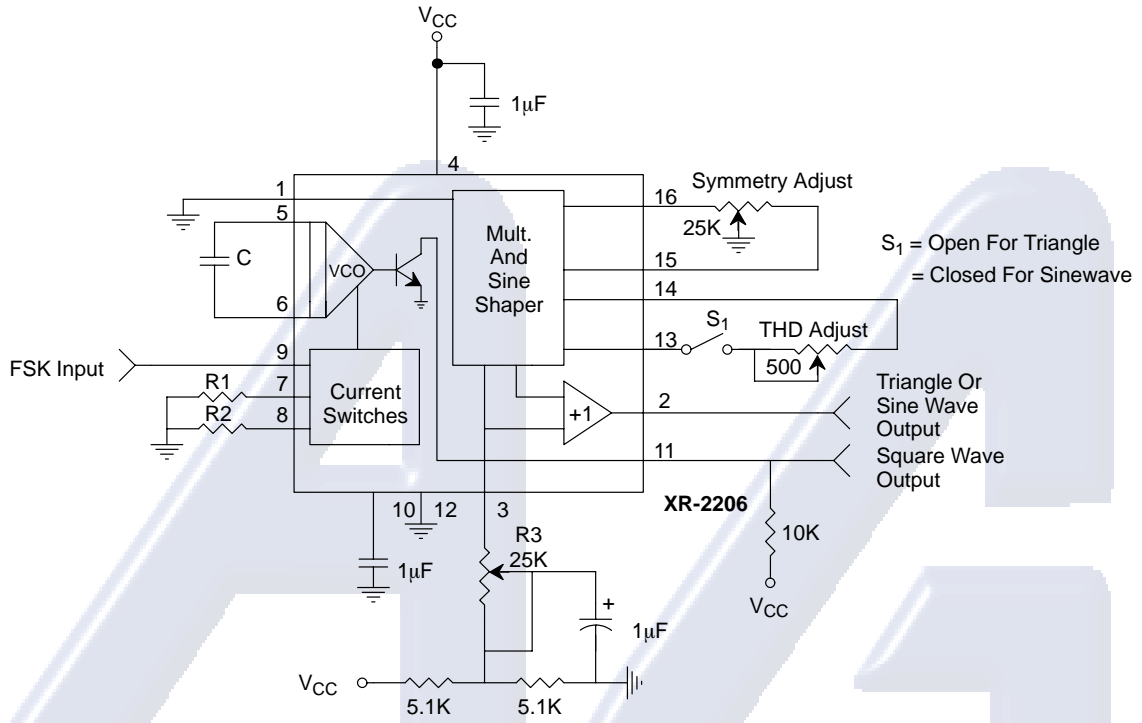

Figure 2. Basic Test Circuit

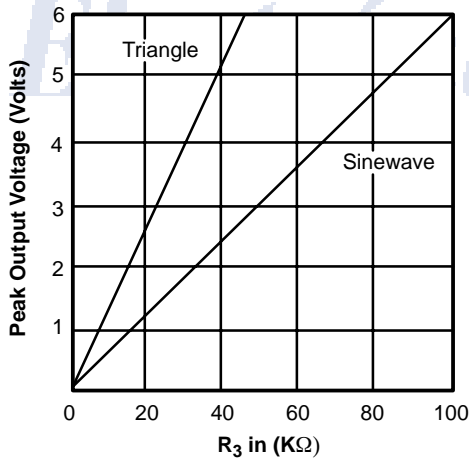

Figure 3. Output Amplitude as a Function of the Resistor, R₃, at Pin 3

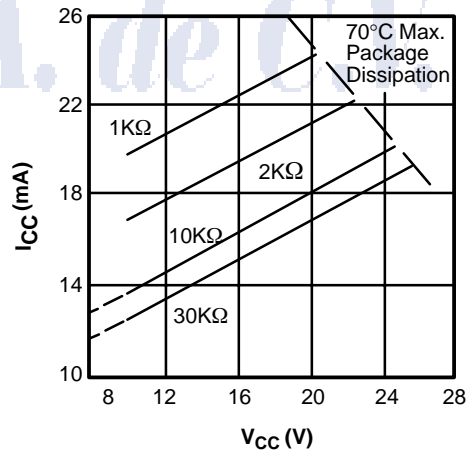

Figure 4. Supply Current vs Supply Voltage, Timing, R

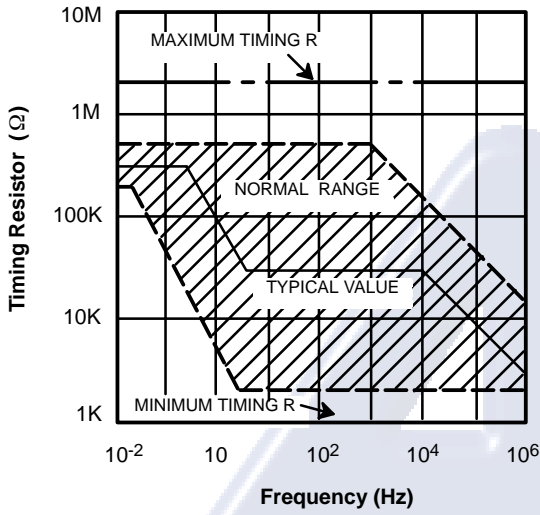

Figure 5. R versus Oscillation Frequency.

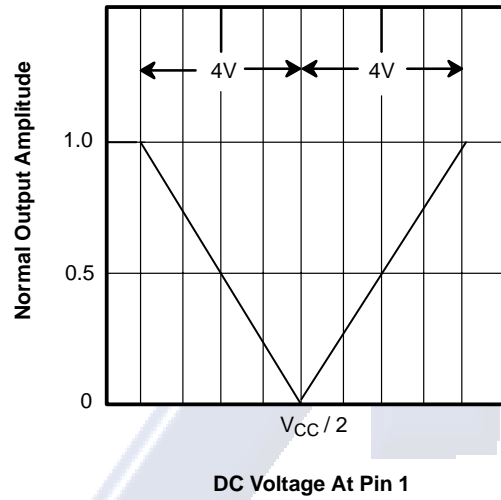

Figure 6. Normalized Output Amplitude versus DC Bias at AM Input (Pin 1)

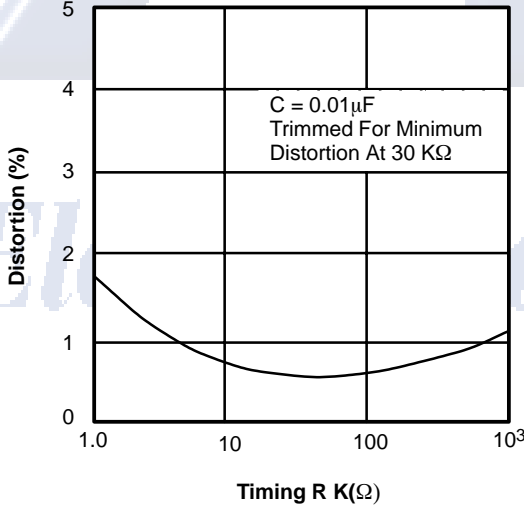

Figure 7. Trimmed Distortion versus Timing Resistor.

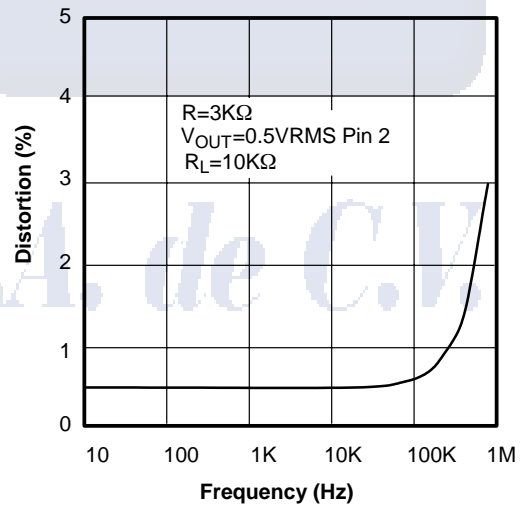

Figure 8. Sine Wave Distortion versus Operating Frequency with Timing Capacitors Varied.

XR-2206

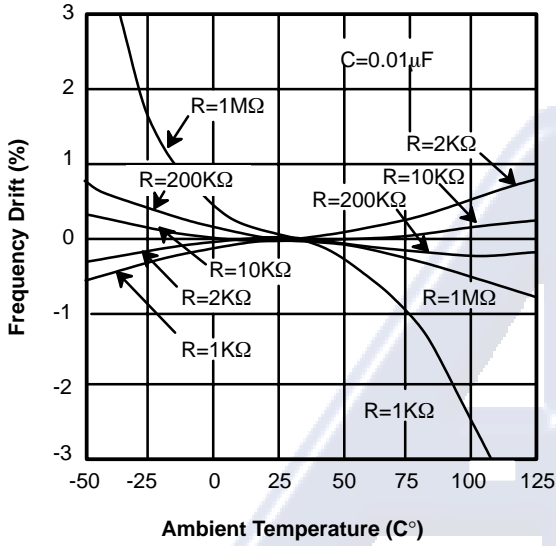

Figure 9. Frequency Drift versus Temperature.

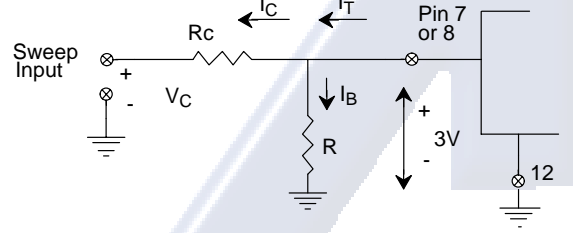

Figure 10. Circuit Connection for Frequency Sweep.

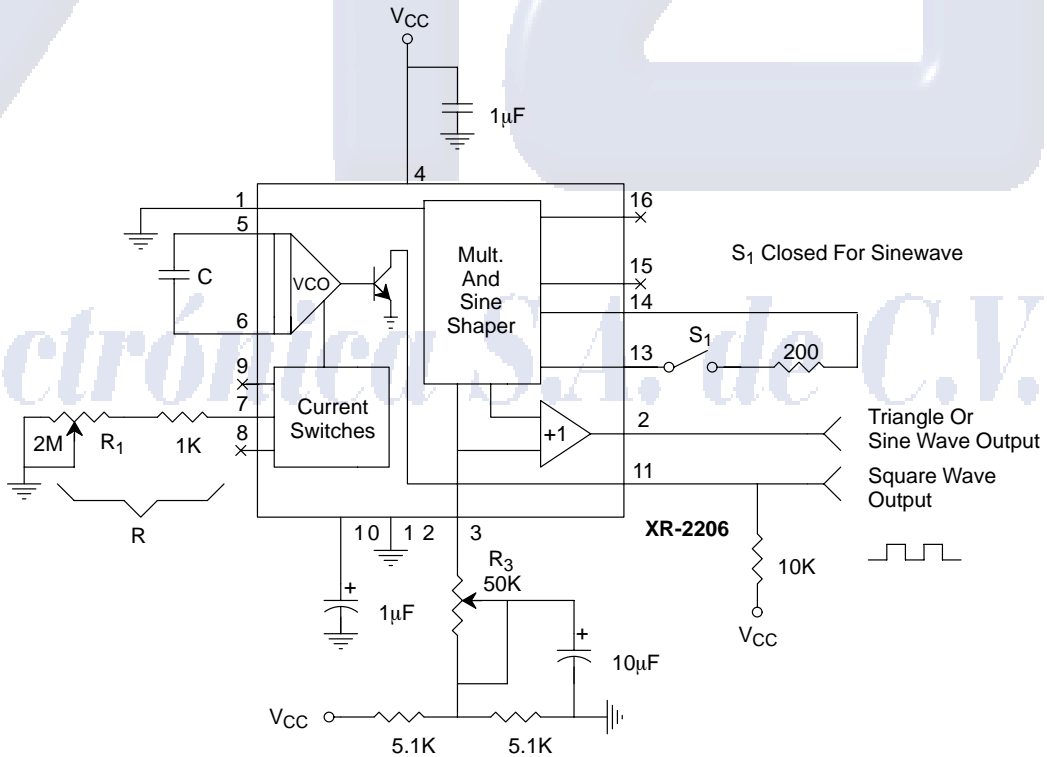

Figure 11. Circuit for Sine Wave Generation without External Adjustment. (See Figure 3 for Choice of R_3)

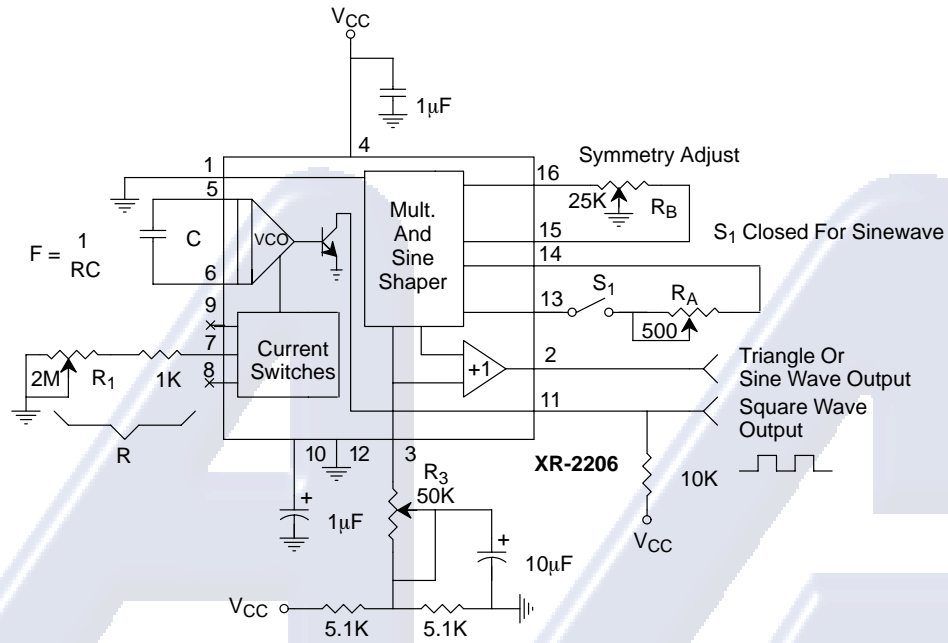

Figure 12. Circuit for Sine Wave Generation with Minimum Harmonic Distortion. (R₃ Determines Output Swing - See Figure 3)

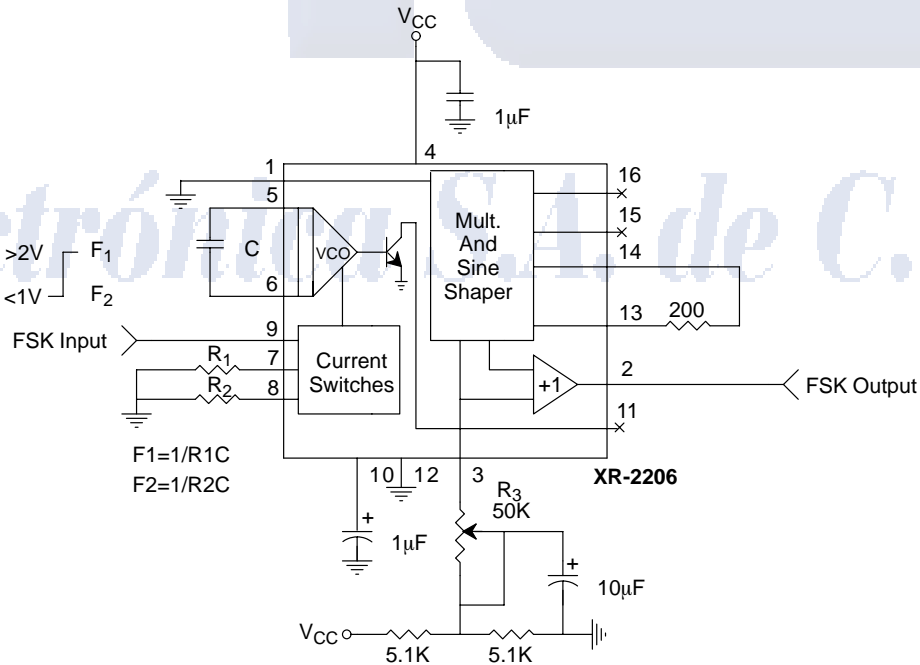

Figure 13. Sinusoidal FSK Generator

XR-2206

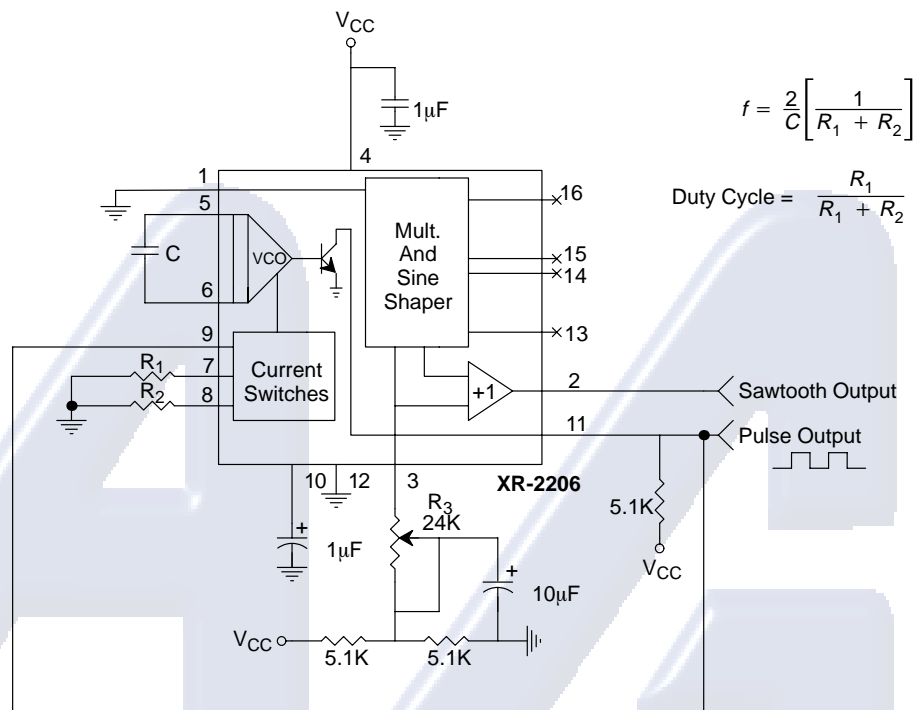

Figure 14. Circuit for Pulse and Ramp Generation.

Frequency-Shift Keying

The XR-2206 can be operated with two separate timing resistors, R_1 and R_2 , connected to the timing Pin 7 and 8, respectively, as shown in *Figure 13*. Depending on the polarity of the logic signal at Pin 9, either one or the other of these timing resistors is activated. If Pin 9 is open-circuited or connected to a bias voltage $\geq 2V$, only R_1 is activated. Similarly, if the voltage level at Pin 9 is $\leq 1V$, only R_2 is activated. Thus, the output frequency can be keyed between two levels. f_1 and f_2 , as:

$$f_1 = 1/R_1C \text{ and } f_2 = 1/R_2C$$

For split-supply operation, the keying voltage at Pin 9 is referenced to V^- .

Output DC Level Control

The dc level at the output (Pin 2) is approximately the same as the dc bias at Pin 3. In *Figure 11*, *Figure 12* and *Figure 13*, Pin 3 is biased midway between V^+ and ground, to give an output dc level of $\approx V^+/2$.

APPLICATIONS INFORMATION

Sine Wave Generation

Without External Adjustment

Figure 11 shows the circuit connection for generating a sinusoidal output from the XR-2206. The potentiometer, R_1 at Pin 7, provides the desired frequency tuning. The maximum output swing is greater than $V^+/2$, and the typical distortion (THD) is $< 2.5\%$. If lower sine wave distortion is desired, additional adjustments can be provided as described in the following section.

The circuit of *Figure 11* can be converted to split-supply operation, simply by replacing all ground connections with V^- . For split-supply operation, R_3 can be directly connected to ground.

With External Adjustment:

The harmonic content of sinusoidal output can be reduced to -0.5% by additional adjustments as shown in *Figure 12*. The potentiometer, R_A , adjusts the sine-shaping resistor, and R_B provides the fine adjustment for the waveform symmetry. The adjustment procedure is as follows:

1. Set R_B at midpoint and adjust R_A for minimum distortion.
2. With R_A set as above, adjust R_B to further reduce distortion.

Triangle Wave Generation

The circuits of *Figure 11* and *Figure 12* can be converted to triangle wave generation, by simply open-circuiting Pin 13 and 14 (i.e., S_1 open). Amplitude of the triangle is approximately twice the sine wave output.

FSK Generation

Figure 13 shows the circuit connection for sinusoidal FSK signal operation. Mark and space frequencies can be independently adjusted by the choice of timing resistors, R_1 and R_2 ; the output is phase-continuous during transitions. The keying signal is applied to Pin 9. The circuit can be converted to split-supply operation by simply replacing ground with V^- .

Pulse and Ramp Generation

Figure 14 shows the circuit for pulse and ramp waveform generation. In this mode of operation, the FSK keying terminal (Pin 9) is shorted to the square-wave output (Pin 11), and the circuit automatically frequency-shift keys itself between two separate frequencies during the positive-going and negative-going output waveforms. The pulse width and duty cycle can be adjusted from 1% to 99% by the choice of R_1 and R_2 . The values of R_1 and R_2 should be in the range of $1k\Omega$ to $2M\Omega$.

PRINCIPLES OF OPERATION

Description of Controls

Frequency of Operation:

The frequency of oscillation, f_0 , is determined by the external timing capacitor, C , across Pin 5 and 6, and by the timing resistor, R , connected to either Pin 7 or 8. The frequency is given as:

$$f_0 = \frac{1}{RC} \text{ Hz}$$

and can be adjusted by varying either R or C . The recommended values of R , for a given frequency range, as shown in *Figure 5*. Temperature stability is optimum for $4k\Omega < R < 200k\Omega$. Recommended values of C are from $1000pF$ to $100\mu F$.

Frequency Sweep and Modulation:

Frequency of oscillation is proportional to the total timing current, I_T , drawn from Pin 7 or 8:

$$f = \frac{320I_T(mA)}{C(\mu F)} \text{ Hz}$$

Timing terminals (Pin 7 or 8) are low-impedance points, and are internally biased at +3V, with respect to Pin 12. Frequency varies linearly with I_T , over a wide range of current values, from $1\mu A$ to $3mA$. The frequency can be controlled by applying a control voltage, V_C , to the activated timing pin as shown in *Figure 10*. The frequency of oscillation is related to V_C as:

$$f = \frac{1}{RC} \left(1 + \frac{R}{R_c} \left(1 - \frac{V_C}{3} \right) \right) \text{ Hz}$$

where V_C is in volts. The voltage-to-frequency conversion gain, K , is given as:

$$K = \partial f / \partial V_C = - \frac{0.32}{R_c C} \text{ Hz/V}$$

CAUTION: For safety operation of the circuit, I_T should be limited to $\leq 3mA$.

XR-2206



Output Amplitude:

Maximum output amplitude is inversely proportional to the external resistor, R_3 , connected to Pin 3 (see *Figure 3*). For sine wave output, amplitude is approximately 60mV peak per k Ω of R_3 ; for triangle, the peak amplitude is approximately 160mV peak per k Ω of R_3 . Thus, for example, $R_3 = 50\text{k}\Omega$ would produce approximately 13V sinusoidal output amplitude.

Amplitude Modulation:

Output amplitude can be modulated by applying a dc bias and a modulating signal to Pin 1. The internal impedance

at Pin 1 is approximately 100k Ω . Output amplitude varies linearly with the applied voltage at Pin 1, for values of dc bias at this pin, within 14 volts of $V_{CC}/2$ as shown in *Figure 6*. As this bias level approaches $V_{CC}/2$, the phase of the output signal is reversed, and the amplitude goes through zero. This property is suitable for phase-shift keying and suppressed-carrier AM generation. Total dynamic range of amplitude modulation is approximately 55dB.

CAUTION: AM control must be used in conjunction with a well-regulated supply, since the output amplitude now becomes a function of V_{CC} .

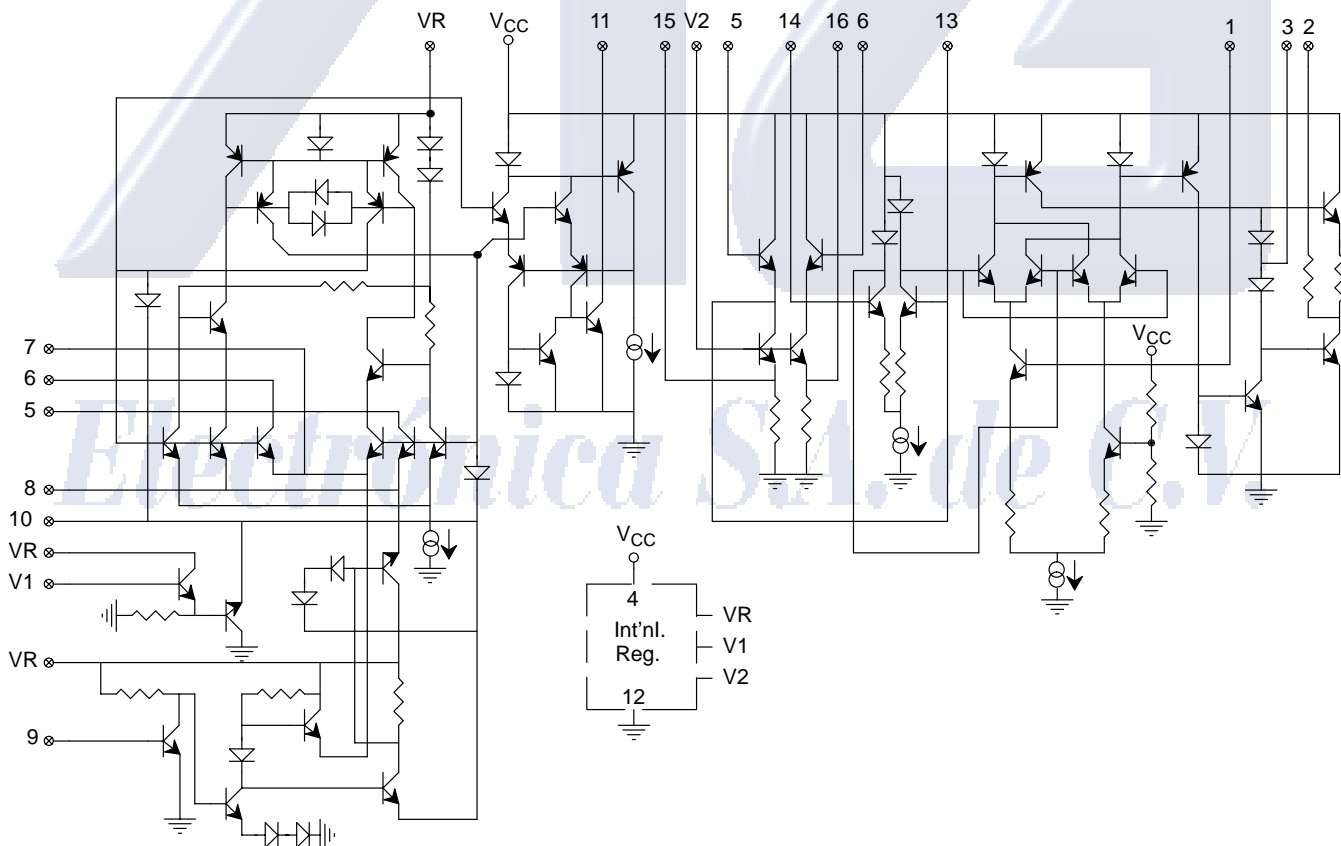
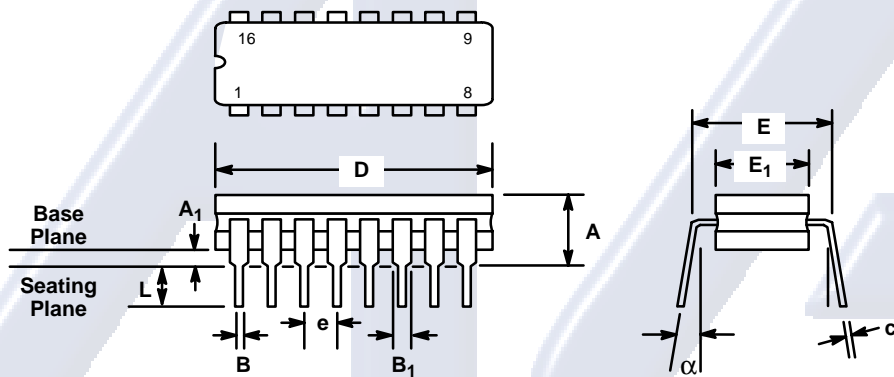

Figure 15. Equivalent Schematic Diagram

16 LEAD CERAMIC DUAL-IN-LINE (300 MIL CDIP)

Rev. 1.00



SYMBOL	INCHES		MILLIMETERS	
	MIN	MAX	MIN	MAX
A	0.100	0.200	2.54	5.08
A ₁	0.015	0.060	0.38	1.52
B	0.014	0.026	0.36	0.66
B ₁	0.045	0.065	1.14	1.65
c	0.008	0.018	0.20	0.46
D	0.740	0.840	18.80	21.34
E ₁	0.250	0.310	6.35	7.87
E	0.300 BSC		7.62 BSC	
e	0.100 BSC		2.54 BSC	
L	0.125	0.200	3.18	5.08
α	0°	15°	0°	15°

Note: The control dimension is the inch column

XR-2206

16 LEAD PLASTIC DUAL-IN-LINE (300 MIL PDIP)

Rev. 1.00

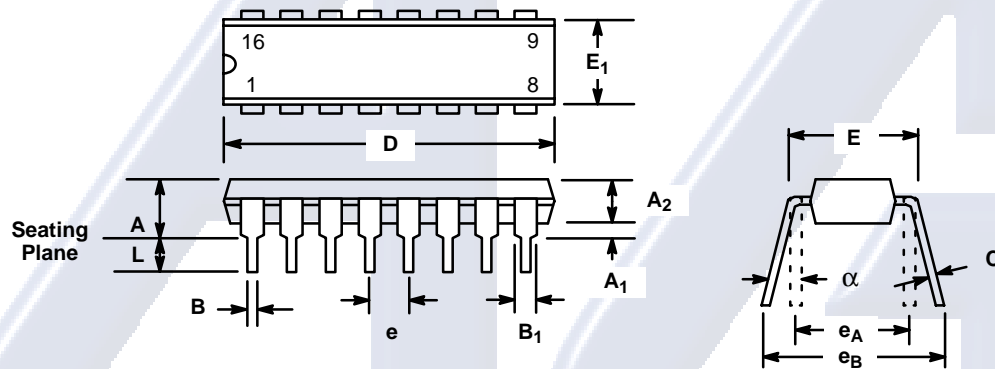

SYMBOL	INCHES		MILLIMETERS	
	MIN	MAX	MIN	MAX
A	0.145	0.210	3.68	5.33
A ₁	0.015	0.070	0.38	1.78
A ₂	0.115	0.195	2.92	4.95
B	0.014	0.024	0.36	0.56
B ₁	0.030	0.070	0.76	1.78
C	0.008	0.014	0.20	0.38
D	0.745	0.840	18.92	21.34
E	0.300	0.325	7.62	8.26
E ₁	0.240	0.280	6.10	7.11
e	0.100 BSC		2.54 BSC	
e _A	0.300 BSC		7.62 BSC	
e _B	0.310	0.430	7.87	10.92
L	0.115	0.160	2.92	4.06
α	0°	15°	0°	15°

Note: The control dimension is the inch column

16 LEAD SMALL OUTLINE (300 MIL JEDEC SOIC)

Rev. 1.00

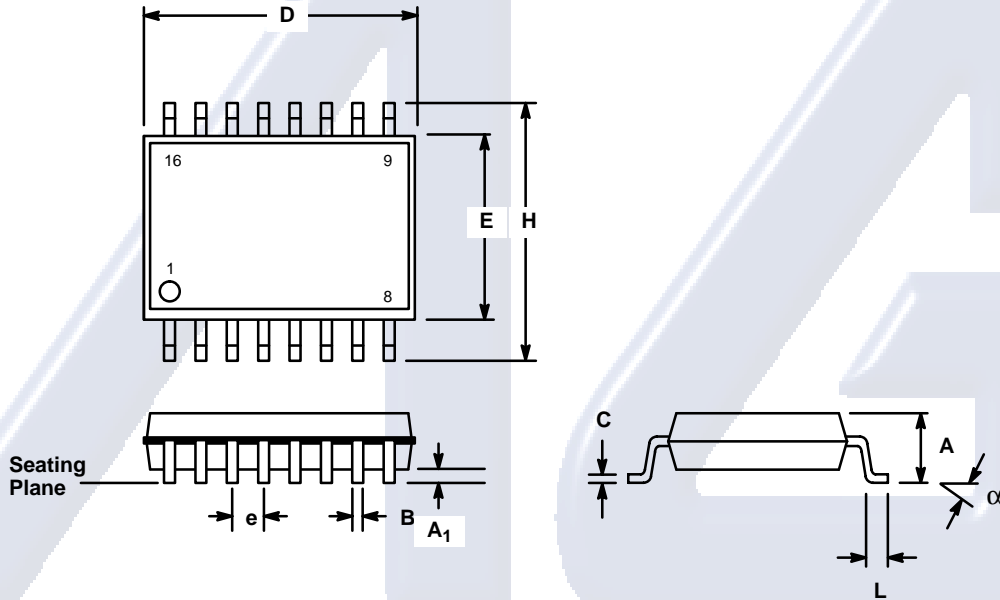

Electrónica S.A. de C.V.

SYMBOL	INCHES		MILLIMETERS	
	MIN	MAX	MIN	MAX
A	0.093	0.104	2.35	2.65
A ₁	0.004	0.012	0.10	0.30
B	0.013	0.020	0.33	0.51
C	0.009	0.013	0.23	0.32
D	0.398	0.413	10.10	10.50
E	0.291	0.299	7.40	7.60
e	0.050 BSC		1.27 BSC	
H	0.394	0.419	10.00	10.65
L	0.016	0.050	0.40	1.27
α	0°	8°	0°	8°

Note: The control dimension is the millimeter column

XR-2206



NOTICE

EXAR Corporation reserves the right to make changes to the products contained in this publication in order to improve design, performance or reliability. EXAR Corporation assumes no responsibility for the use of any circuits described herein, conveys no license under any patent or other right, and makes no representation that the circuits are free of patent infringement. Charts and schedules contained here in are only for illustration purposes and may vary depending upon a user's specific application. While the information in this publication has been carefully checked; no responsibility, however, is assumed for inaccuracies.

EXAR Corporation does not recommend the use of any of its products in life support applications where the failure or malfunction of the product can reasonably be expected to cause failure of the life support system or to significantly affect its safety or effectiveness. Products are not authorized for use in such applications unless EXAR Corporation receives, in writing, assurances to its satisfaction that: (a) the risk of injury or damage has been minimized; (b) the user assumes all such risks; (c) potential liability of EXAR Corporation is adequately protected under the circumstances.

Copyright 1972 EXAR Corporation

Datasheet June 1997

Reproduction, in part or whole, without the prior written consent of EXAR Corporation is prohibited.

